

FIAT DUCATO 2.0 MJT "115 HP" EURO5

---

**Codice/Code: 2HDFI013F**

**+ U003AA044**  (Kit Separatore Olio)  
(Kit Séparateur d'huile)  
(Oil Separator kit)  
(Öabscheider-Einbausatz)  
(Oil Separator kit)

*Abbinamento con DIAVIA FRIGO*  
*Assemblage avec DIAVIA FRIGO*  
*In combination with DIAVIA FRIGO*  
*Mit DIAVIA FRIGO verbunden*  
*Acoplamiento con DIAVIA FRIGO*

---

**Istruzioni di montaggio**

**Instructions pour le montage**

**Fitting instructions**

**Einbauanleitungen**

**Instrucciones de montaje**

**DESCRIZIONE SIMBOLOGIA UTILIZZATA / DESCRIPTION DE LA SYMBOLOGIE UTILISÉE  
DESCRIPTION OF SYMBOLS USED / BESCHREIBUNG DER VERWENDETEN SYMBOLIK  
DESCRIPCIÓN DE LOS SIMBOLOS UTILIZADOS**

1A

Riferimento a figura / Référence à la figure / See figure  
In Bezug auf Abbildungen / Referencia a la figura

1- 1

Riferimento a componenti di fornitura / Référence aux composants de la fourniture  
See supplied components / Bezug auf Gelieferte Einbauelemente  
Referencia a los componentes de abastecimiento

1

Riferimento a posizione schema elettrico / Référence à la position du schéma électrique  
See position in wiring diagram / In Bezug auf Position im Schaltschema  
Referencia a la posición del esquema eléctrico



- Lubrificare tutti i raccordi e gli O.R. con il nuovo olio refrigerante prima di collegarli  
- Graisser tous les raccords et les O.R. avec le nouveau huile réfrigérant avant de les raccorder

-Lubricate all fittings and O-rings with new refrigerant oil before connecting them

- Alle Verbindungsstücke und OR-Ringe vor deren Verbindung mit dem neuen Kühlmittelöl ölen

- Lubrificar todos los empalmes y los O.R. con el nuevo aceite refrigerante antes de conectarlos

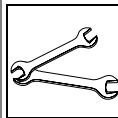

- Per avvitare a fondo o allentare i raccordi tubi gas usare due chiavi per bilanciare coppia di torsione  
- Pour visser à fond ou desserrer les raccords des tuyaux gaz, utiliser le deux clés pour équilibrer le couple de torsion

- When tightening or loosening the fittings of the gas pipes, use two wrenches to equalize the torsion couple

- Um die Verbindungsstücke der Kältemittelschläuche gleichmäßig festzuschrauben oder zu lockern, zwei Schlüssel für das Verschraubungspaar verwenden

- Para enroscar a fondo o aflojar los empalmes tubos gas se deben usar dos llaves para balancear el par de torsión



- Tagliare con utensile appropriato al materiale  
- Couper à l'aide d'outil approprié  
- Cut with a device suitable for the material

- Mit dem Material entsprechendem Werkzeug schneiden

- Cortar con herramienta apropiada al material

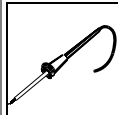
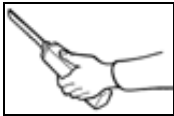

- Stagnare  
- Étamer  
- Tin  
- Verzinnen  
- Estañar



- Spianare  
- Nivelar  
- Flatten out  
- Richten  
- Nivelar

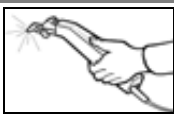

- Tagliare con utensile a lama calda  
- Couper à l'aide d'un outil à lame chaude  
- Cut using the tool with heated blade.  
- Mit Schweißmesserwerkzeug schneiden  
- Cortar con útil a hoja caliente

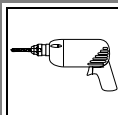

- Forare  
- Percer  
- To drill  
- Durchbohren  
- Taladrar

Pos.	ITALIANO	FRANÇAIS	ENGLISH	DEUTSCH	ESPAÑOL
C	Compressore	Compresseur	Compressor	Kompressor	Compresor
31	Condensatore	Condenseur	Condenser	Kondensator	Condensador
32	Staffa superiore di supporto condensatore	Etrier supérieur de support condenseur	Upper condenser support bracket	Oberer Kondensator-Halgebügel	Abrazadera superior de soporte condensador
33	Staffa inferiore di supporto condensatore	Étrier inférieur de support condenseur	Lower condenser support bracket	Unterer Kondensatorhalgebügel	Abrazadera inferior de soporte condensador
34	Staffa ausiliaria superiore di supporto condensatore	Étrier auxiliaire supérieur de support condenseur	Upper condenser auxiliary support bracket	Oberer Zusatzbügel des Kondensatorträgers	Abrazadera auxiliar superior de soporte condensador
35	Sacchetto accessori	Sachet accessoires	Bag of accessories	Säckchen mit Zuberhörteilen	Bolsita accesorios
39	Staffa ausiliaria di supporto Impianto elettrico elettroventole	Etrier auxiliaire de support équipement électrique ventilateurs	Auxiliary support bracket for fan wiring	Zusatz-Halterungsbügel der elektrischen Anlage des Gebläses	Abrazadera auxiliar de soporte Instalación eléctrica electroventiladores
40	Copri-relais	Couvre-relais	Relay cover	Relais-Verkleidung	Cubre-realais
41	Fascetta in gomma	Collier en caoutchouc	Rubber clamp	Gummischelle	Banda de goma
42-43 44	Fermatubo	Fixation tuyau	Pipe clamp	Schlauchbinder	Detiene tubo
51	Filtro essiccatore	Filtre déshydrateur	Receiver drier	Trocknerfilter	Filtro secador
52	Staffa filtro	Etrier filtre	Receiver drier bracket	Filterbügel	Abrazadera filtro
53	Pressostato	Pressostat	Pressure switch	Druckwächter	Presostato
54	Sacchetto accessori per separatore olio	Sachet accessoires pour séparateur huile	Bag of accessories for oil separator	Säckchen mit Zuberhörteilen für Ölabscheider	Bolsita accesorio para separador aceite
55	Separatore olio	Séparateur huile	Oil separator	Ölabscheider	Separador aceite
56	Staffa separatore olio	Etrier séparateur huile	Oil separator bracket	Ölabscheiderbügel	Abrazadera separadora aceite
57	Staffa ausiliaria per separatore olio	Étrier auxiliaire pour séparateur huile	Auxiliary oil separator bracket	Zusatzbügel für Öltrenner	Abrazadera auxiliar para separador aceite
60	Sacchetto fissaggio tubi gas	Sachet fixation tuyaux gaz	Bag of gas pipe securing elements	Säckchen mit Kältemittelschlauch-Befestigung	Bolsita sujeción tubos gas
60.1	Protezione a spirale	Protection en spirale	Spiral protection	Spiralförmige Ummantelung	Protección a espiral

Pos.	ITALIANO	FRANÇAIS	ENGLISH	DEUTSCH	ESPAÑOL
60.2	Fascetta fissatubo a 2 vie	Collier de fixation tuyau à 2 voies	2-way hose clamp	Befestigungsschelle des 2-weg Schlauchs	Banda fijación tubo a 2 vías
60.3 60.4 60.5	Fascetta in gomma	Collier en caoutchouc	Rubber clamp	Gummischelle	Banda de goma
72A	Sede comandi personalizzata	Logement de commandes personnalisées	Customized control housing	Persönlich gestalterter Steuerungssitz	Caja mandos personalizada
76	Contenitore olio	Révoir huile	Oil tank	Ölbehälter	Contenedor aceite
101	Indicatore passaggio liquido e umidità	Indicateur passage liquide et humidité	Liquid flow and humidity indicator	Anzeiger des Flüssigkeits- und Feuchtigkeitsdurchlaufs	Indicador pasaje líquido y humedad
106	Impianto elettrico Elettroventole	Installation électrique electroventilateurs	Fans electric system	Elektrische Anlage Elektrolüfter	Instalación eléctrica electroventiladores
107	Terminale	Borne	Terminal	Endstecker	Terminale
108	Prolunga cavi per compressore	Rallonge câbles pour compresseur	Compressor extension wire	Verlängerungskabel für Kompressor	Extensible cables para compresor
111	Impianto elettrico intermedio	Faisceau électrique intermédiaire	Intermediate wiring system	Elektrische Zwischenanlage	Instalación eléctrica intermedia
111.1	Gommino passacavi	Pièce en caoutchouc passe-câbles	Rubber wires lead	Kabeldurchgang	Goma pasacables
118	Sacchetto raccordi	Sachet raccords	Bag of findings	Säckchen mit Verbindungsstücken	Bolsita racores
119 120 121	Tubo gas	Tuyau gaz	Gas hose	Kältemittelschlauch	Tubo gas
122 123 124	Fascetta per raccordi tubi gas	Collier pour raccords tuyaux gaz	Clamp for gas hose connection	Schelle für Verbindungsstücke der Kältemittelschläuche	Banda para racores tubos gas
125 ↓ 136	Raccordo tubo gas	Raccord tuyau gaz	Gas hose connection	Kältemittelschlauchverbindungsstück	Racor tubo gas
<b>K</b>	Raccordo con punto di carica	Raccord avec point de charge	Charge point connection	Verbindungsstück mit Füllpunkt	Racor con punto de carga
	Fascetta a strappo	Bride auto-bloquant	Self-locking clamp	Selbstsichernde Schelle	Banda autobloqueante

**MONTAGGIO COMPRESSORE / POSE DU COMPRESSEUR / COMPRESSOR FITTING  
KOMPRESSOREINBAU / MONTAJE COMPRESOR**

MATERIALE FORNITO / MATERIEL FOURNI / SUPPLIED MATERIAL / GELIEFERTES MATERIAL / MATERIAL ABASTECIDO

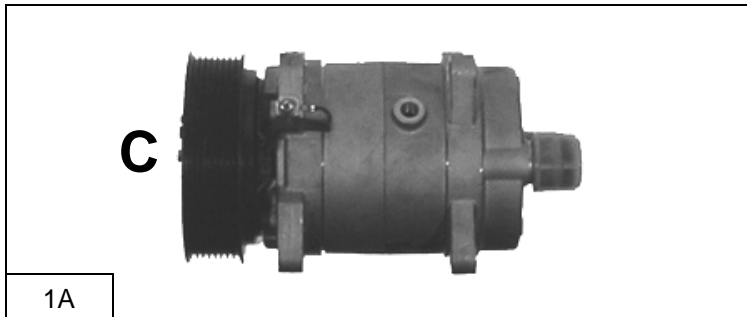

1A

Pos.	Descrizione / Description / Description Beschreibung / Descripción	Codice / Code Kode / Código
C	Compressore	015201/1

**(I)**  
ATTENZIONE:  
*Le operazioni di montaggio del compressore, sono illustrate nel manuale di istruzioni fornito unitamente al KIT COMPRESSORE, a cui si rimanda l'installatore.*

**(F)**  
ATTENTION:  
*Les opérations de montage du compresseur, sont illustrées dans le manuel d'instruction fourni avec KIT COMPRESSEUR, auquel se reporte l'installateur.*

**(GB)**  
WARNING:  
*See the instruction manual supplied with the COMPRESSOR KIT for instructions on the operations involved in installing the Compressor.*

**(D)**  
ACHTUNG:  
*Die Einbauschritte der Kompressor sind im mitgelieferten Anleitungshandbuch der KOMPRESSOR KIT Einheit dargestellt und vom Einbauer einzuhalten.*

**(E)**  
ATENCIÓN:  
*Las operaciones de montaje del compresor se ilustran en el manual de instrucciones suministrado con el KIT COMPRESOR, el cual debe ser consultado por el instalador.*

**MONTAGGIO CONDENSATORE / POSE DU CONDENSEUR / CONDENSER FITTING  
KONDENSATOREINBAU / MONTAJE CONDENSADOR**

MATERIALE FORNITO / MATERIEL FOURNI / SUPPLIED MATERIAL / GELIEFERTES MATERIAL / MATERIAL ABASTECIDO

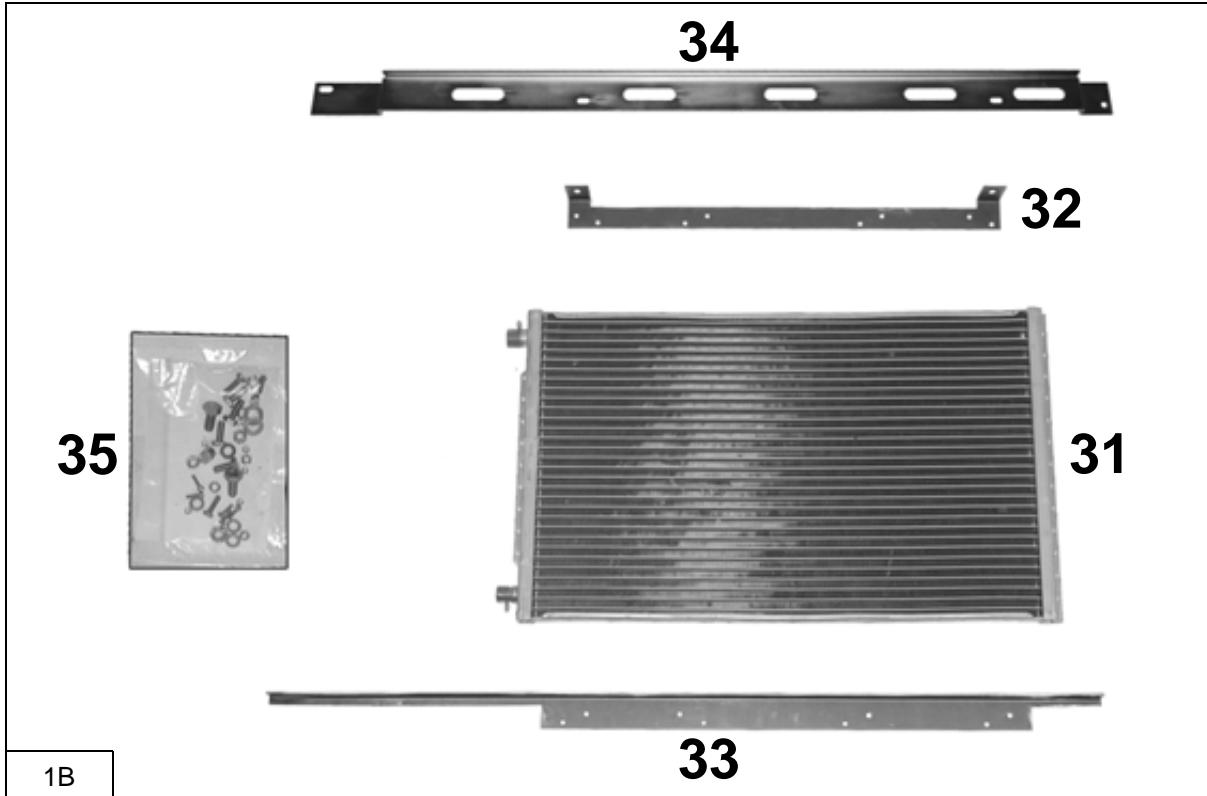

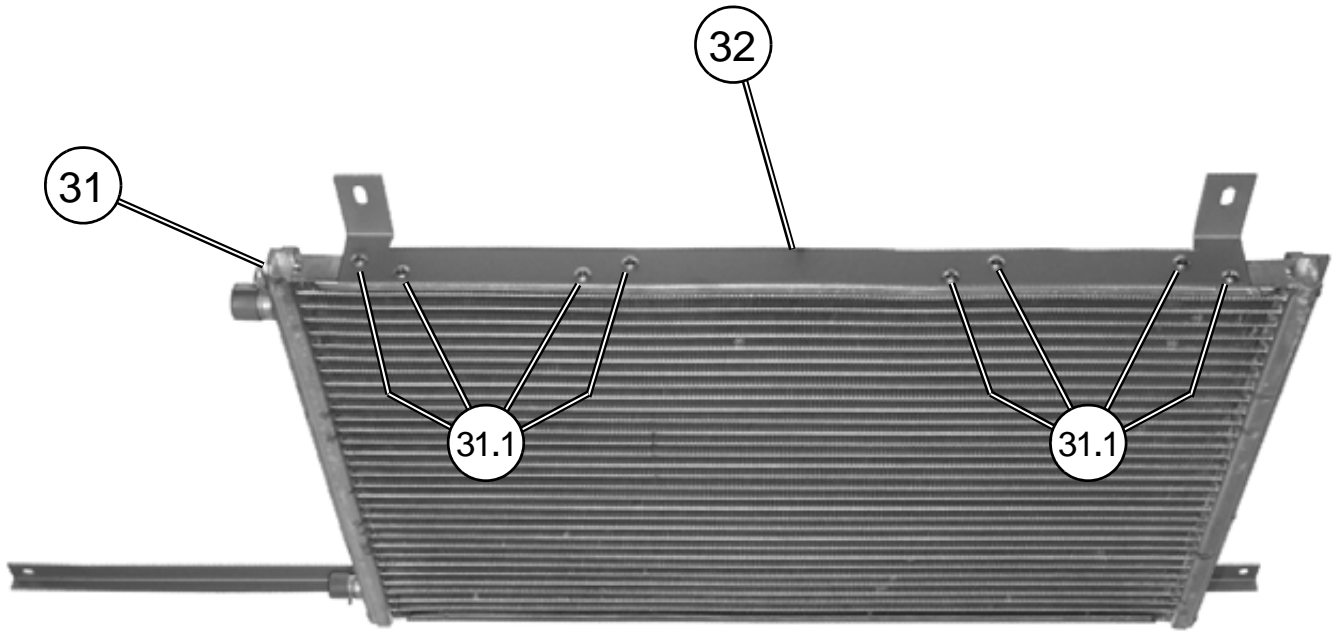

1B

Pos.	Descrizione / Description / Description Beschreibung / Descripción	Codice / Code Kode / Código
31	Condensatore	022301OR/1
32	Staffa superiore di supporto condensatore	0813029/0
33	Staffa inferiore di supporto condensatore	0813027/0
34	Staffa ausiliaria superiore di supporto condensatore	0813096/0
35	Sacchetto accessori	0232108/0

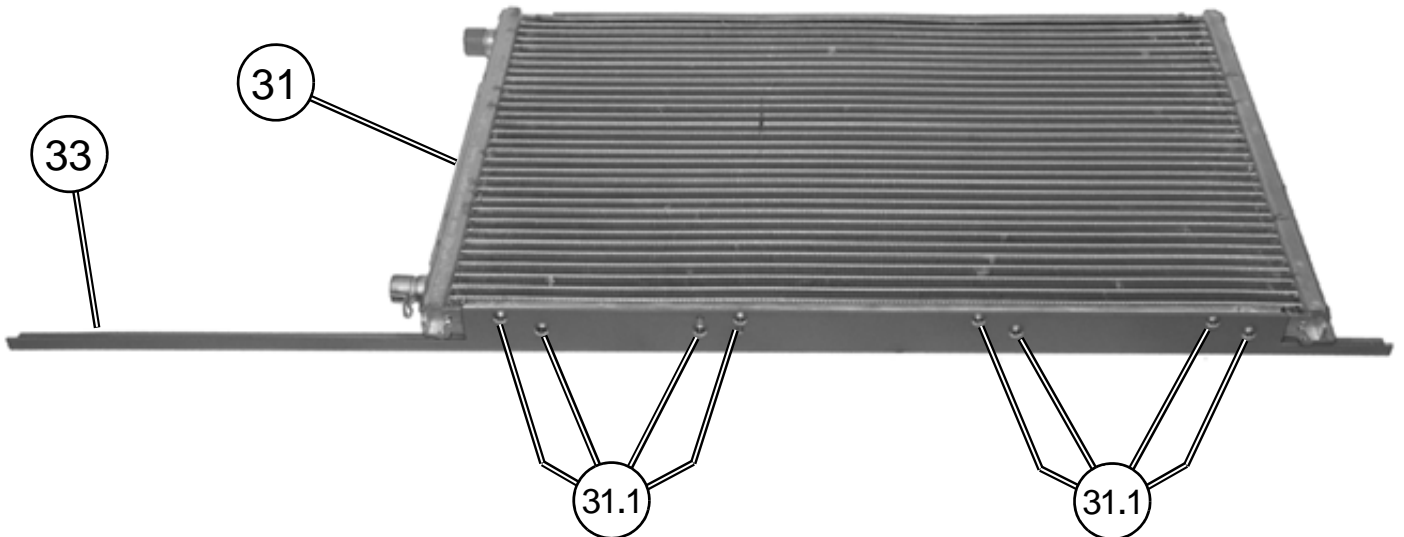

2B



ELEMENTI DI FISSAGGIO / PIECES DE FIXATION / FIXING PARTS BEFESTIGUNGSELEMENTE / ELEMENTOS DE FIJACION		
Pos.	Tipologia / Typologie Typology / Tipologie Tipologia	Descrizione / Description Description / Beschreibung Descripción
31.1		4,2 x 9,5

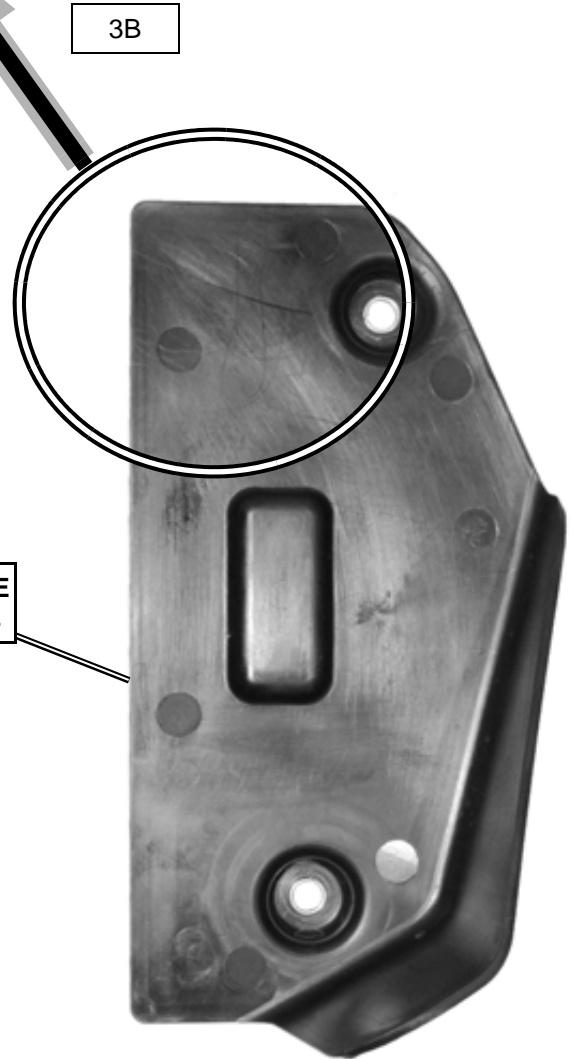
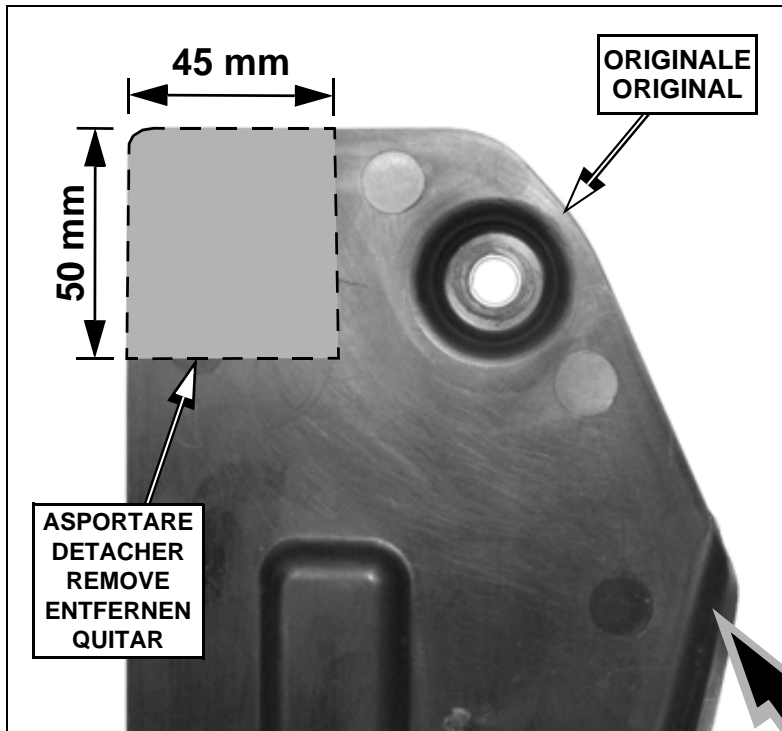



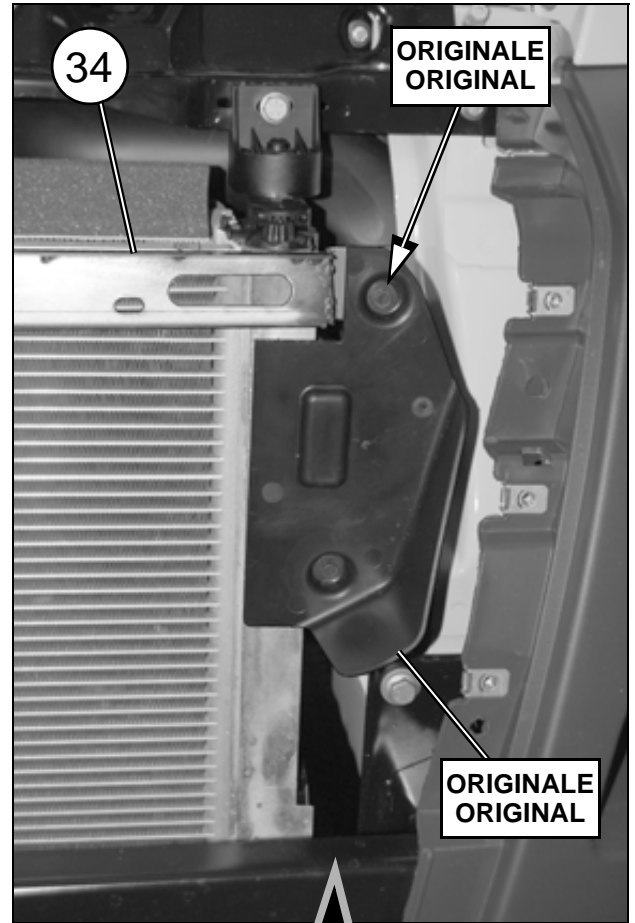
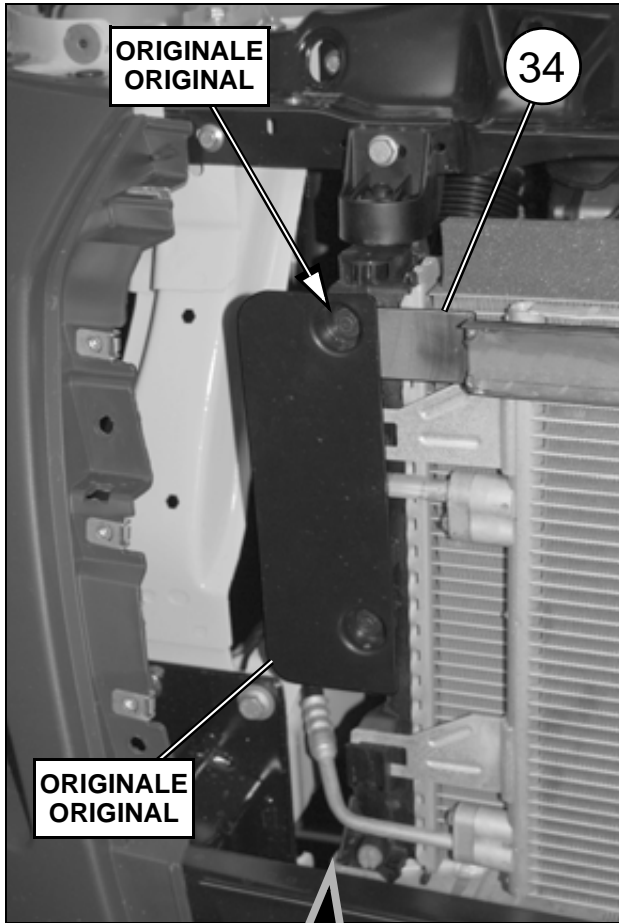

4B

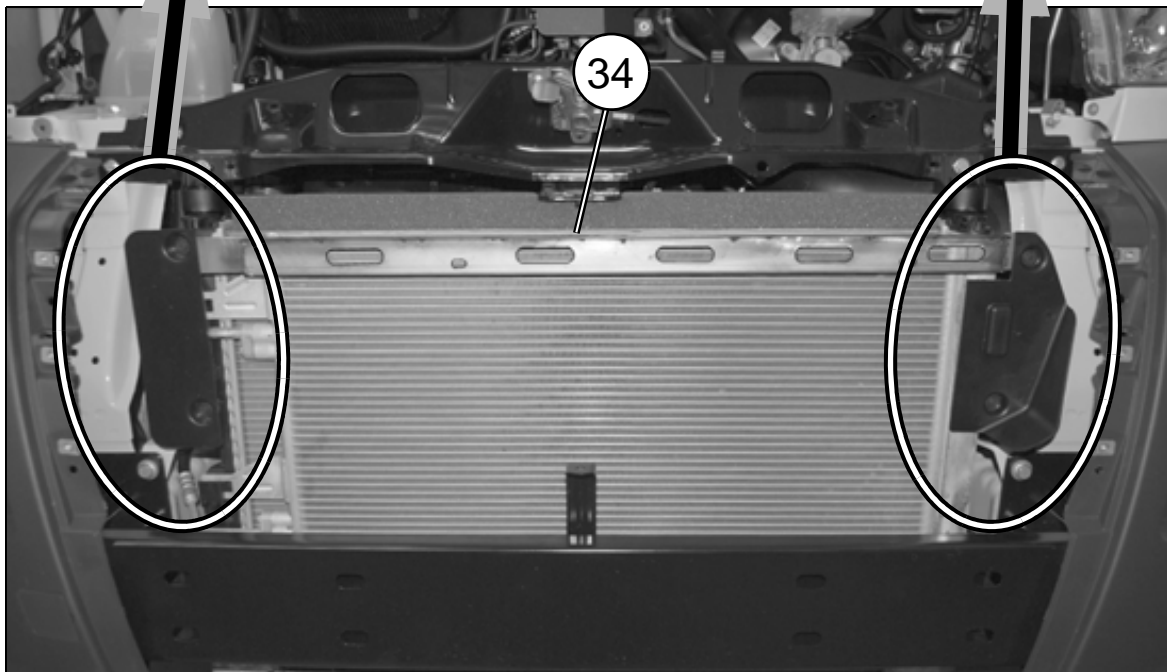

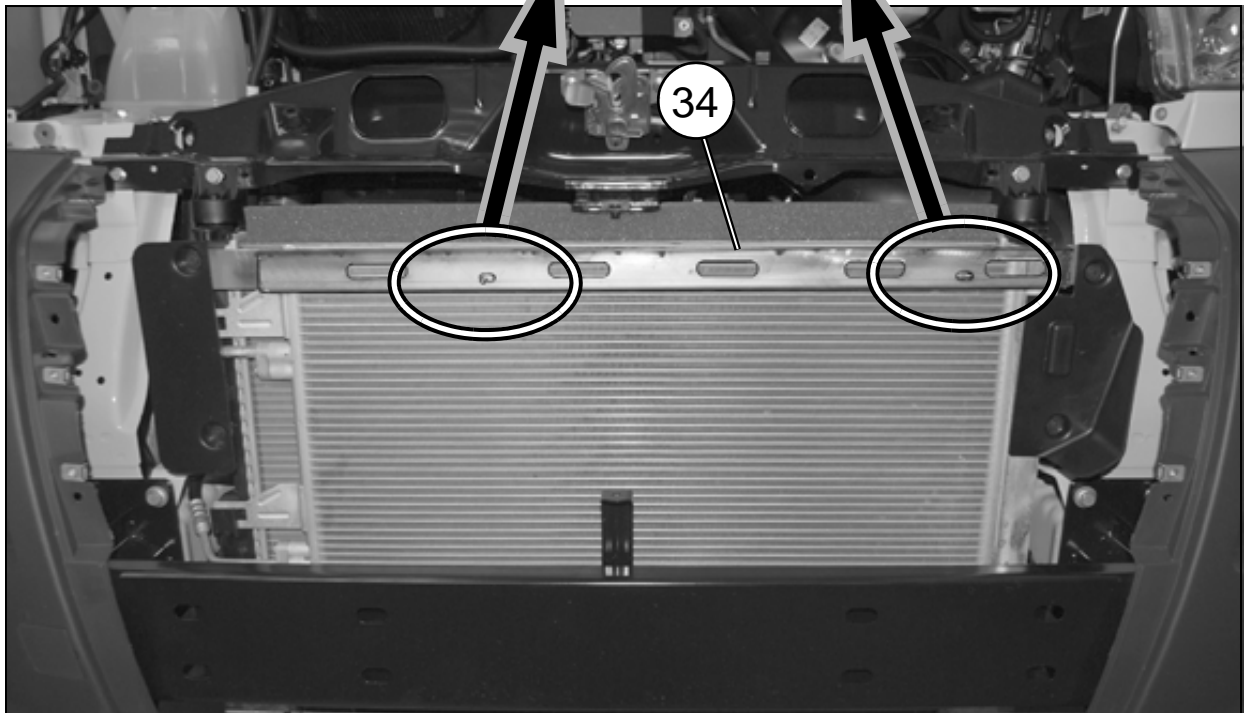
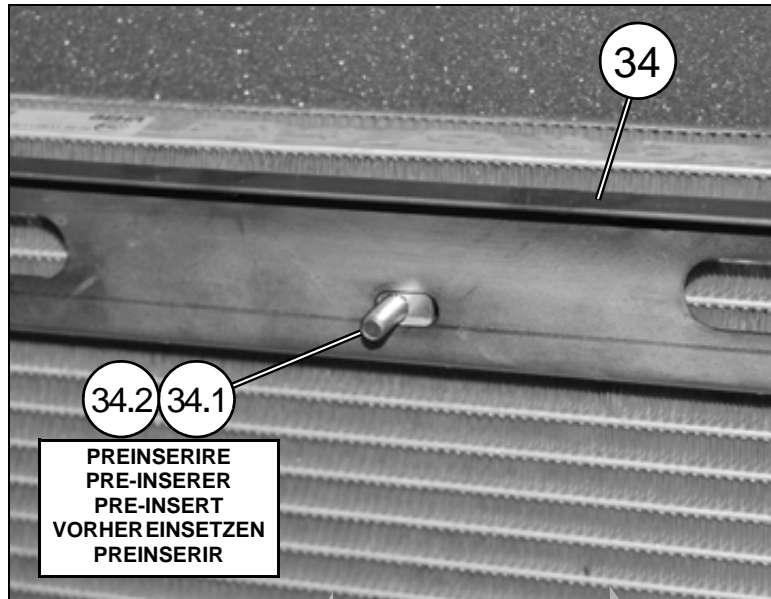



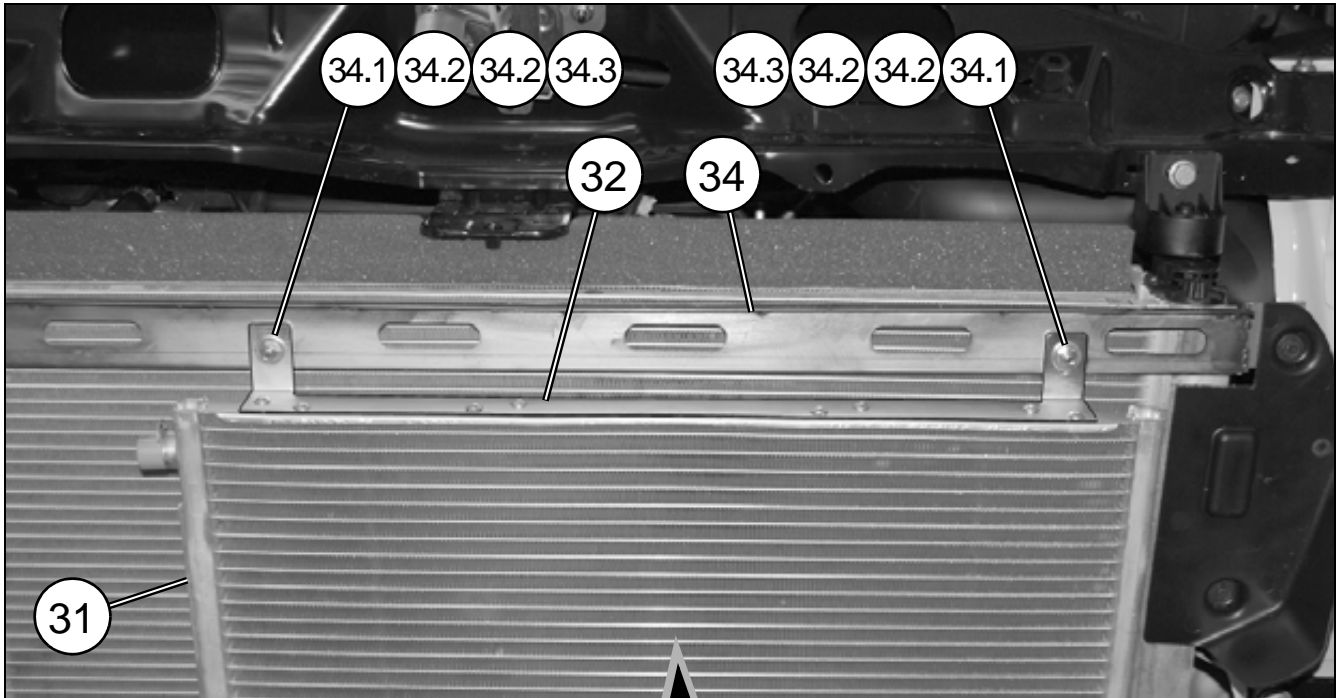

ELEMENTI DI FISSAGGIO / PIECES DE FIXATION / FIXING PARTS BEFESTIGUNGSELEMENTE / ELEMENTOS DE FIJACION		
Pos.	Tipologia / Typologie Typology / Tipologie Tipologia	Descrizione / Description Description / Beschreibung Descripción
34.1		M6 x 16
34.2		φ6 x φ18 x 2

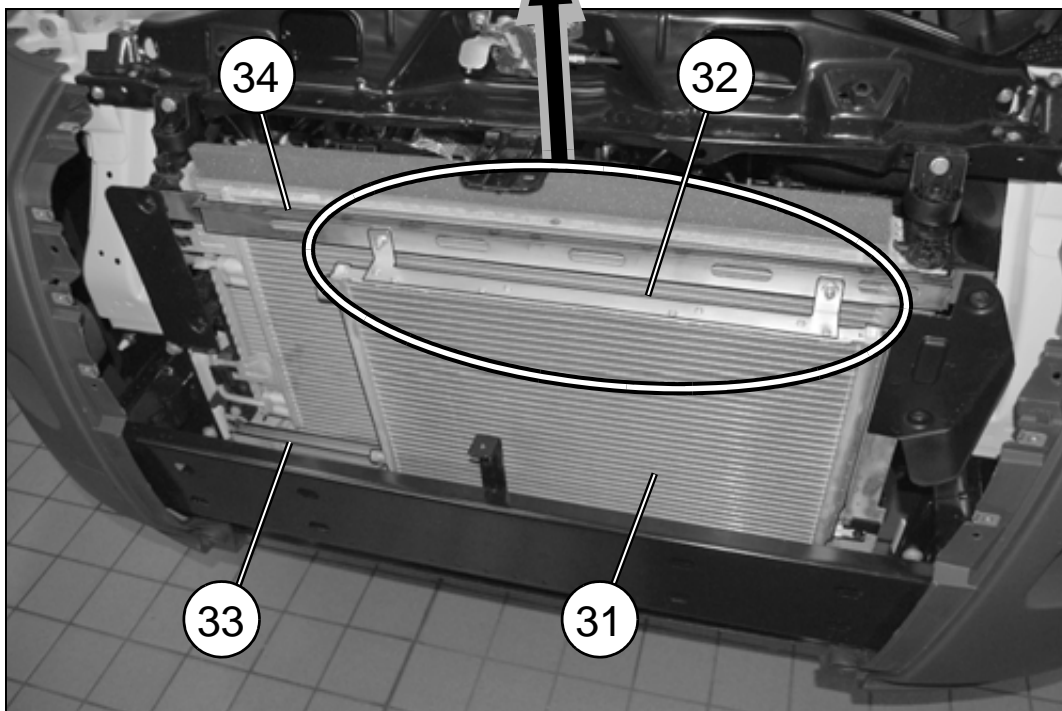

6B



ELEMENTI DI FISSAGGIO / PIECES DE FIXATION / FIXING PARTS BEFESTIGUNGSELEMENTE / ELEMENTOS DE FIJACION		
Pos.	Tipologia / Typologie Typology / Tipologie Tipologia	Descrizione / Description Description / Beschreibung Descripción
34.1		M6 x 16
34.2		φ6 x φ18 x 2
34.3		M6

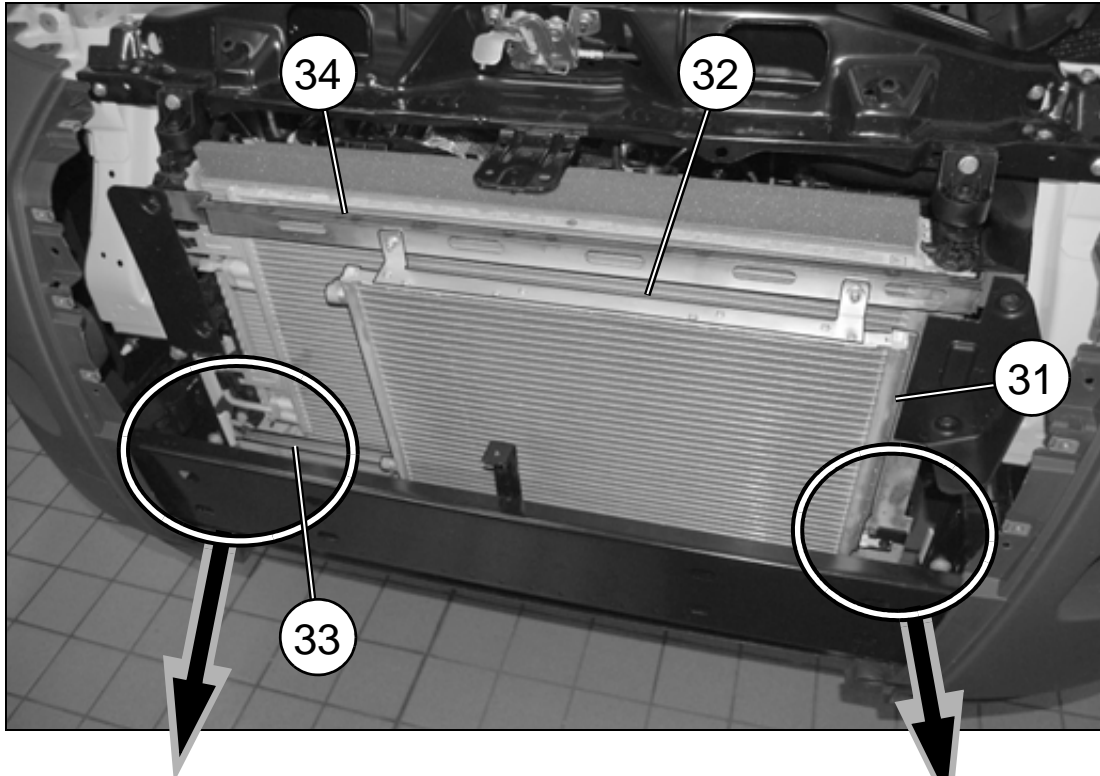

7B

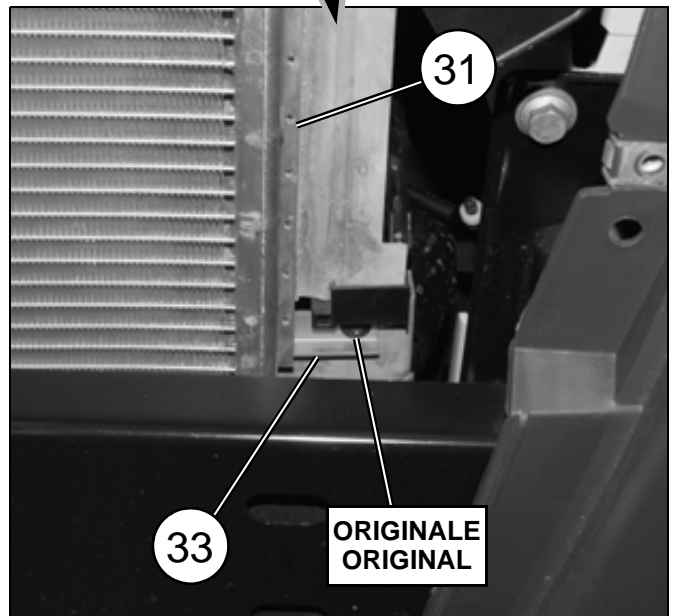
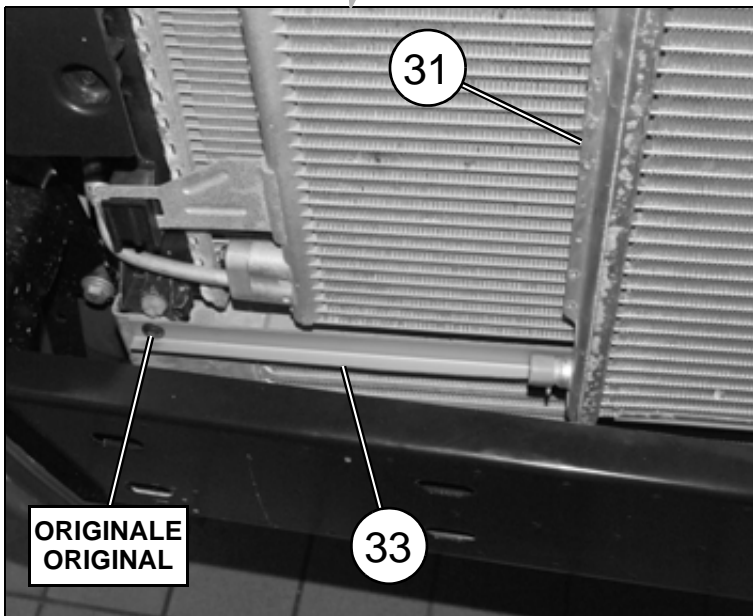

**MONTAGGIO FILTRO ESSICCATORE / POSE DU FILTRE DESHYDRATEUR / RECEIVER DRIER ASSEMBLY  
TROCKNERFILTER EINBAU / MONTAJE DEL FILTRO SECADOR**

**MATERIALE FORNITO / MATERIEL FOURNI / SUPPLIED MATERIAL / GELIEFERTES MATERIAL / MATERIAL ABASTECIDO**

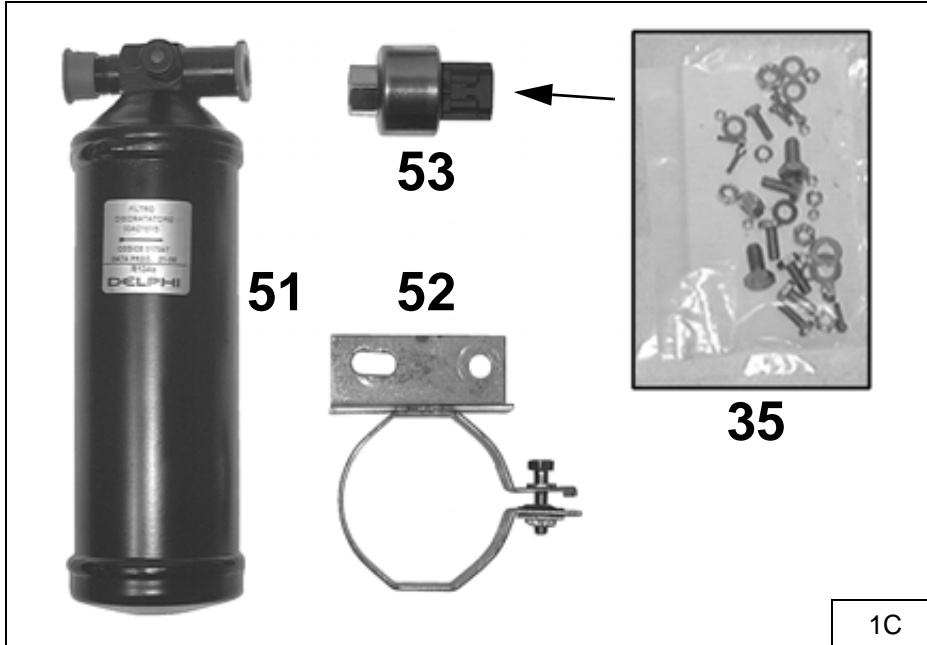

Pos.	Descrizione / Description / Description Beschreibung / Descripción	Codice / Code Kode / Código
35	Sacchetto accessori	0232108/0
51	Filtro essiccatore	017047/1
52	Staffa filtro	0361819/0
53	Pressostato	043396/0

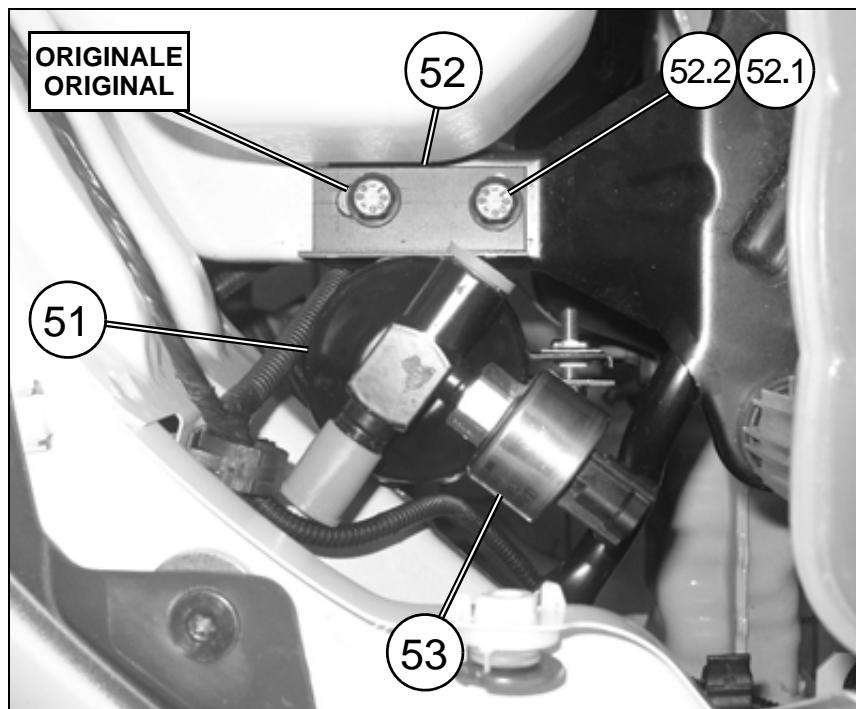
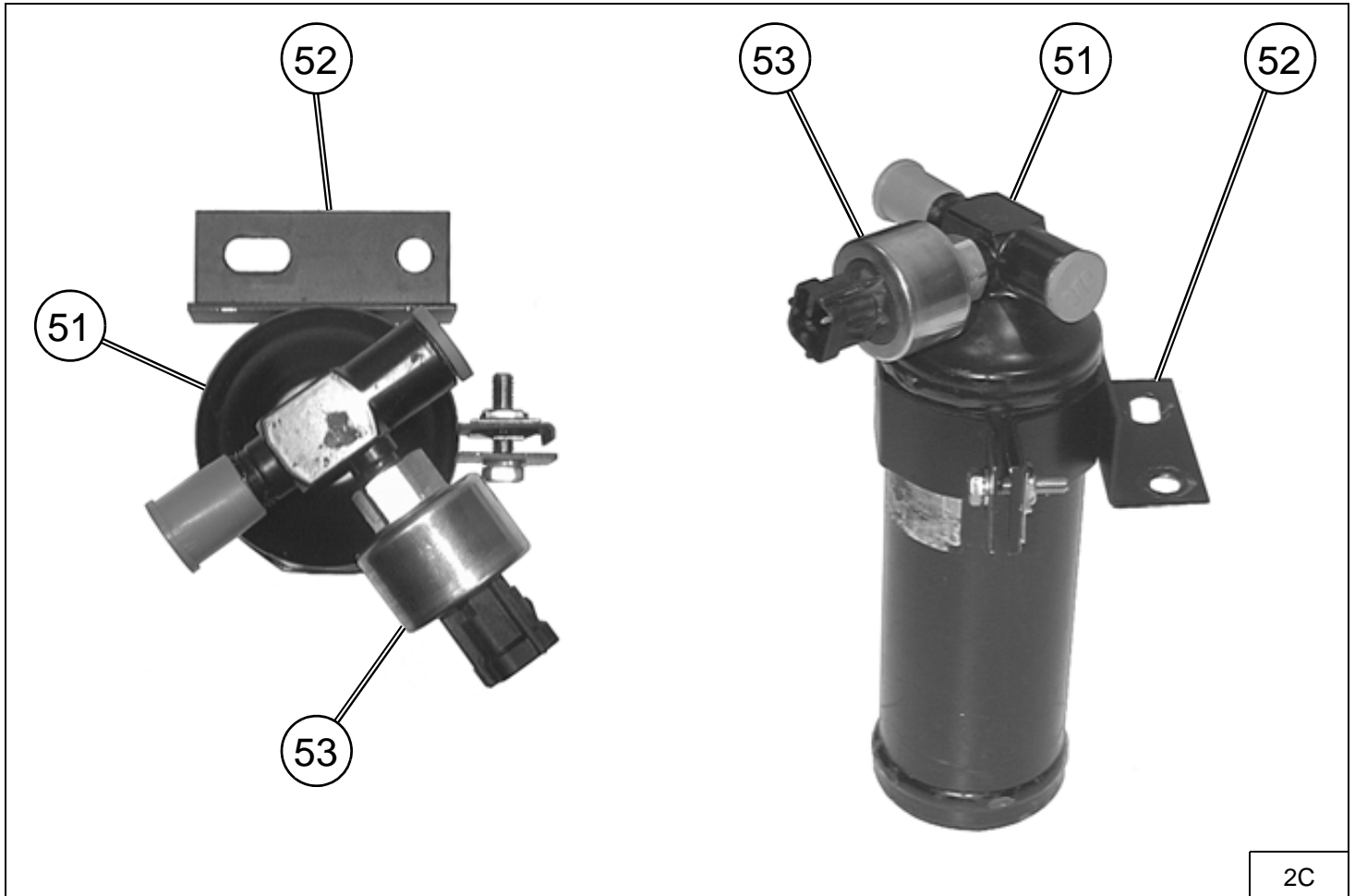

3C

ELEMENTI DI FISSAGGIO / PIECES DE FIXATION FIXING PARTS / BEFESTIGUNGSELEMENTE ELEMENTOS DE FIJACION		
Pos.	Tipologia / Typologie Typology / Tipologie Tipologia	Descrizione / Description Description / Beschreibung Descripción
52.1		M8 x 20
52.2		φ 8

**MONTAGGIO SEPARATORE OLIO / MONTAGE SEPARATEUR HUILE  
INSTALLATION OF OIL SEPARATOR / EINBAU DES OELABSCHIEDERS / MONTAJE SEPARADOR ACEITE**

*Componenti forniti a richiesta con **Kit U003AA044** - (vedi anche fig. 3.2F).  
Composants fournis à la demande avec **Kit U003AA044** - (voir aussi fig. 3.2F).  
Components supplied upon request with **Kit U003AA044** - (also see the fig. 3.2F).  
Auf Anfrage mit **Einbausatz U003AA044** gelieferte Einbauteile - (siehe auch abb. 3.2F).  
Componentes suministrados con **kit U003AA044** bajo petición - (véase también fig.3.2F).*

**MATERIALE FORNITO / MATERIEL FOURNI / SUPPLIED MATERIAL / GELIEFERTES MATERIAL / MATERIAL ABASTECIDO**

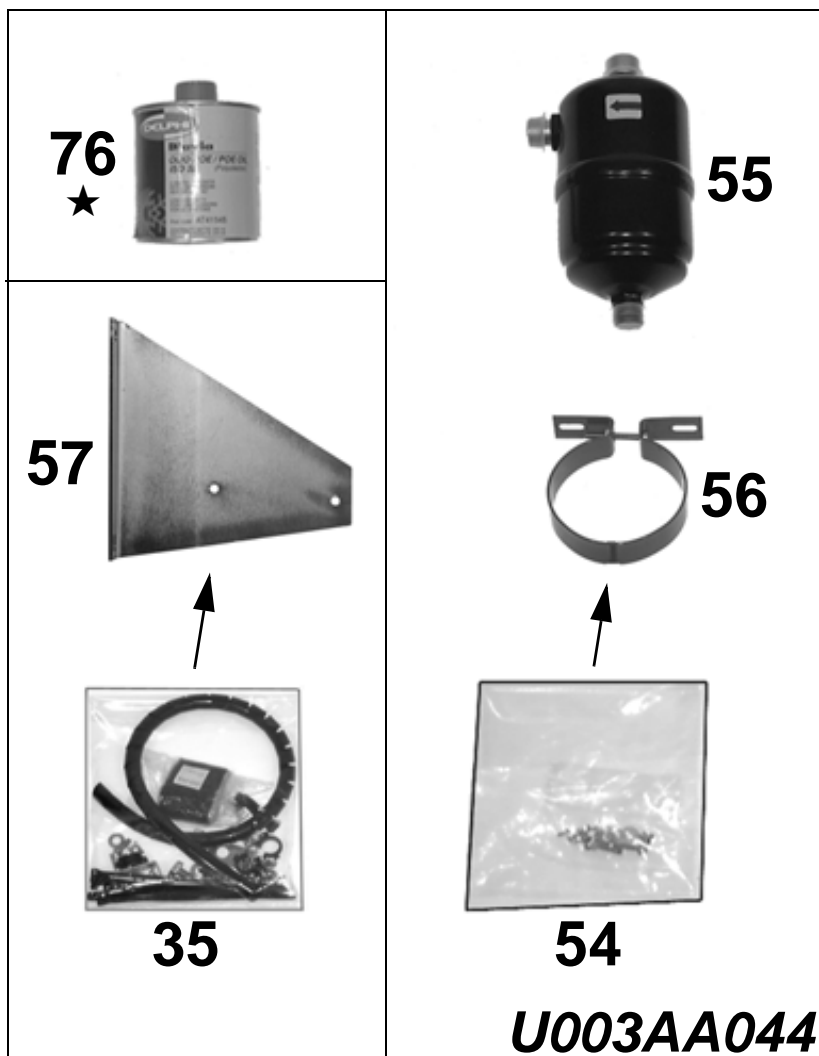

Pos.	Descrizione / Description / Description / Beschreibung / Descripción	Codice / Code / Kode / Código
35	Sacchetto accessori	0232108/0
54	Sacchetto accessori per separatore olio	0231654/0
55	Separatore olio	043265/0
56	Staffa separatore olio	0601499/0
57	Staffa ausiliaria per separatore olio	0361902/0
76★	Contenitore olio	-
★	<i>Componente fornito nel Kit DIAVIA FRIGO Composant fourni dans le kit DIAVIA FRIGO Component supplied in Kit DIAVIA FRIGO Mit Einbausatz DIAVIA FRIGO gelieferte Einbauteile Componente abastecido en el Kit DIAVIA FRIGO</i>	

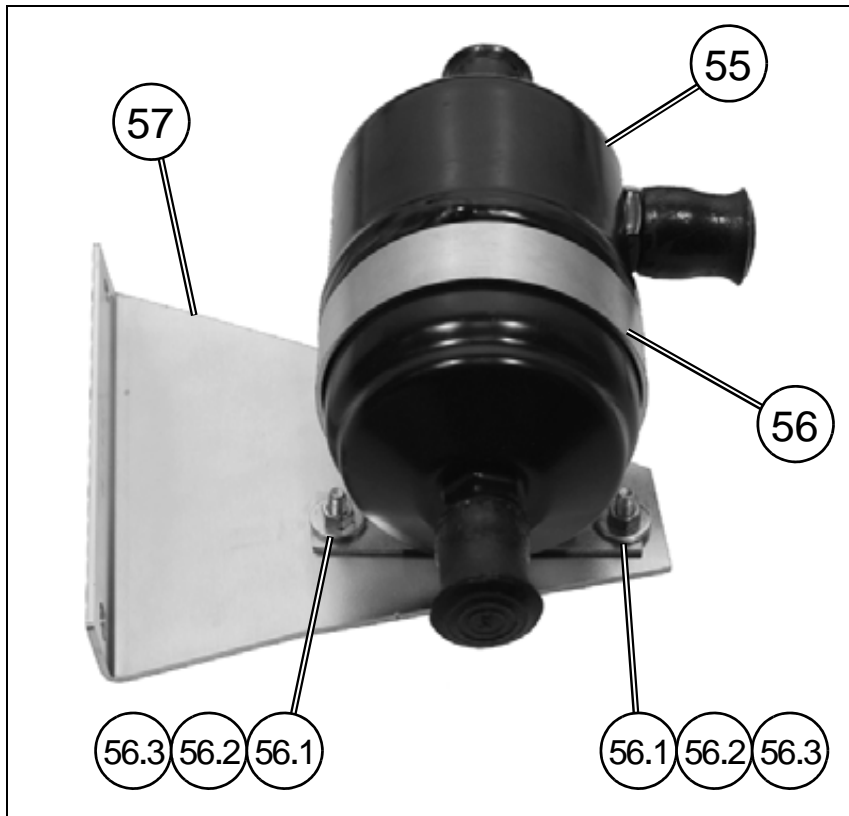

2D

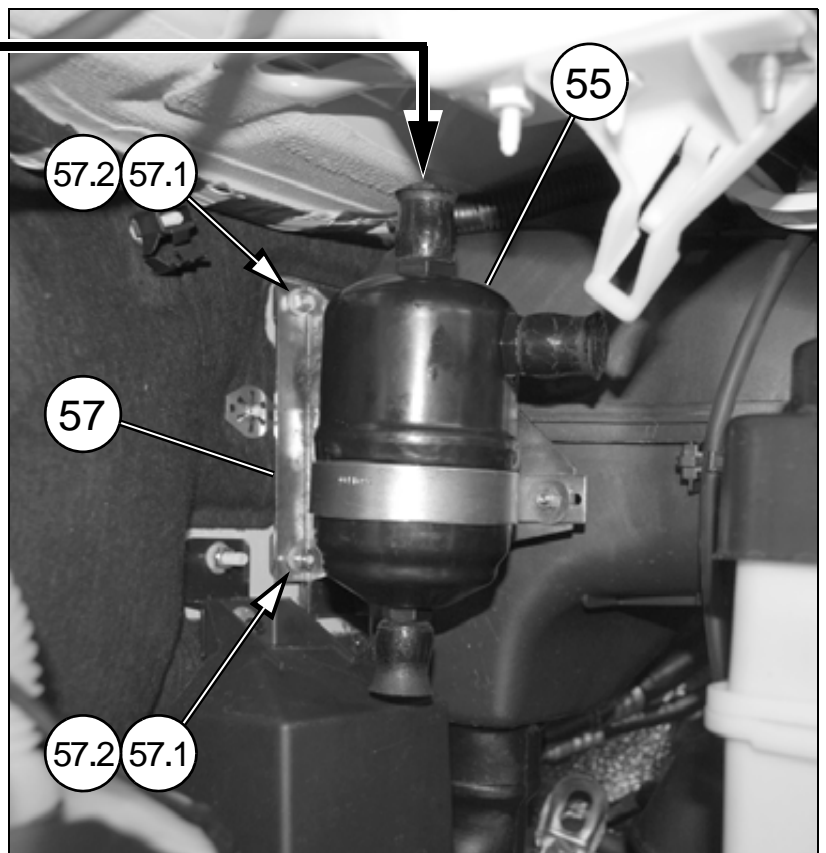

ELEMENTI DI FISSAGGIO / PIÈCES DE FIXATION FIXING PARTS / BEFESTIGUNGSELEMENTE ELEMENTOS DE FIJACION		
Pos.	Tipologia / Typologie Typology / Tipologie Tipologia	Descrizione / Description Description / Beschreibung Descripción
56.1		M5 x 16
56.2		$\phi 5 \times \phi 15 \times 1,5$
56.3		M5
57.1		$\phi 6$
57.2		M6



**MONTAGGIO GRUPPO REFRIGERANTE / POSE DU GROUPE REFRIGERANT  
REFRIGERANT UNIT ASSEMBLY FRIGOSOFT / EINBAU DER KÜHLEINHEIT  
MONTAJE E INSTALACIÓN DEL GRUPO REFRIGERANTE**

**(I)**  
ATTENZIONE:  
*Le operazioni di montaggio dell'unità refrigerante e del gruppo comando con utilizzo del supporto standard, sono illustrate nel manuale di istruzioni fornito unitamente al gruppo DIAVIA FRIGO, a cui si rimanda l'installatore.*  
*Nelle pagine seguenti è illustrato la soluzione alternativa di montaggio del gruppo comando con utilizzo della sede personalizzata "72A" fornita nel presente impianto base.*

**(F)**  
ATTENTION:  
*Les opérations de montage de l'unité réfrigérante et du groupe de commande utilisant le support standard, sont illustrées dans le manuel d'instruction fourni avec le groupe DIAVIA FRIGO, auquel se reporte l'installateur.*  
*Dans les pages suivantes la solution alternative de montage du groupe de commande utilisant le logement personnalisé "72A" fourni dans l'installation de base présente est illustré.*

**(GB)**  
WARNING:  
*See the instruction manual supplied with the DIAVIA FRIGO unit for instructions on the operations involved in installing the refrigerating unit and the controls using the standard support.*  
*The pages below illustrate the alternate installation of the controls using the customized housing "72A" provided in the present basic system.*

**(D)**  
ACHTUNG:  
*Die Einbauschritte der Kühlungseinheit und der Steuerungsgruppe unter Verwendung der Standardträger sind im mitgelieferten Anleitungshandbuch der DIAVIA FRIGO Einheit dargestellt und vom Einbauer einzuhalten.*  
*Auf den folgenden Seiten ist eine alternative Einbaumöglichkeit der Steuerungsgruppe im persönlich gestalteten und mit der Grundausstattung gelieferten Sitz "72A" dargestellt*

**(E)**  
ATENCIÓN:  
*Las operaciones de montaje de la unidad refrigerante y del grupo de mando que utilizan el soporte estándar se ilustran en el manual de instrucciones suministrado con el grupo DIAVIA FRIGO, el cual debe ser consultado por el instalador.*  
*En las páginas siguientes se ilustra una solución alternativa para el montaje del grupo de mando que utiliza la caja personalizada "72A" y que se suministra con esta instalación básica.*

**MATERIALE FORNITO / MATERIEL FOURNI / SUPPLIED MATERIAL / GELIEFERTES MATERIAL / MATERIAL ABASTECIDO**



Pos.	Descrizione / Description Description / Beschreibung Descripción	Codice / Code Code / Código
72A	Sede comandi personalizzata	0322373/0

Soluzione di montaggio gruppo comandi mediante utilizzo della sede personalizzata "72A"  
 Solution de montage du groupe de commandes en utilisant le logement personnalisé "72A"

Solution for installation of the controls with the customized housing "72A"

Einbaumöglichkeit der Steuerungsgruppe unter Verwendung des persönlich gestalteten Steuerungssitzes "72A"  
 Solución para el montaje grupo de mandos utilizando la caja personalizada "72A"

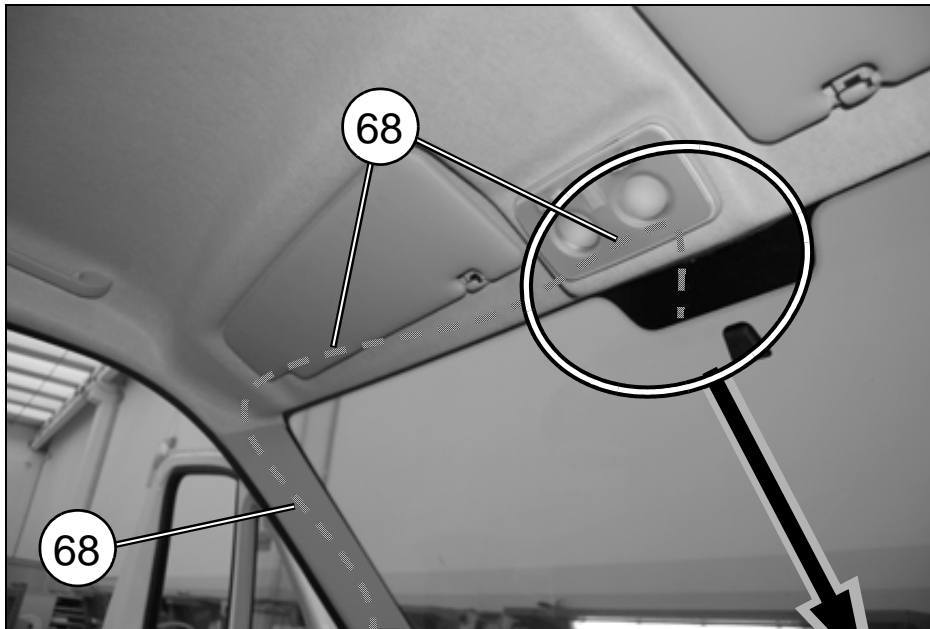

(I)  
 Posizionamento impianto elettrico (68) per display.

(F)  
 Positionnement du faisceau électrique (68) pour display.

(GB)  
 Position of the electric wiring (68) for display.

(D)  
 Positionierung der elektrischen Anlage (68) für Display.

(E)  
 Colocación instalación eléctrica (68) para display.

2E

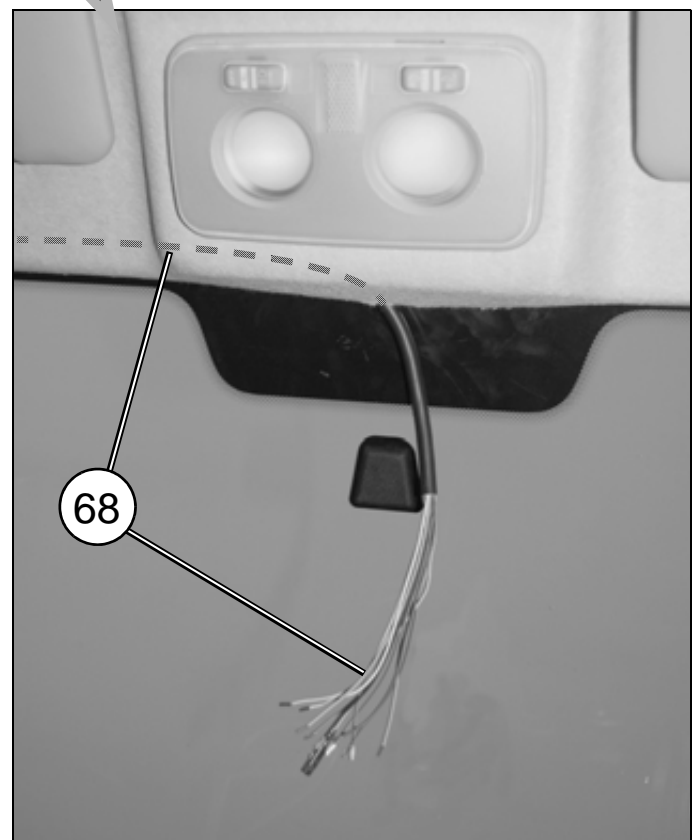
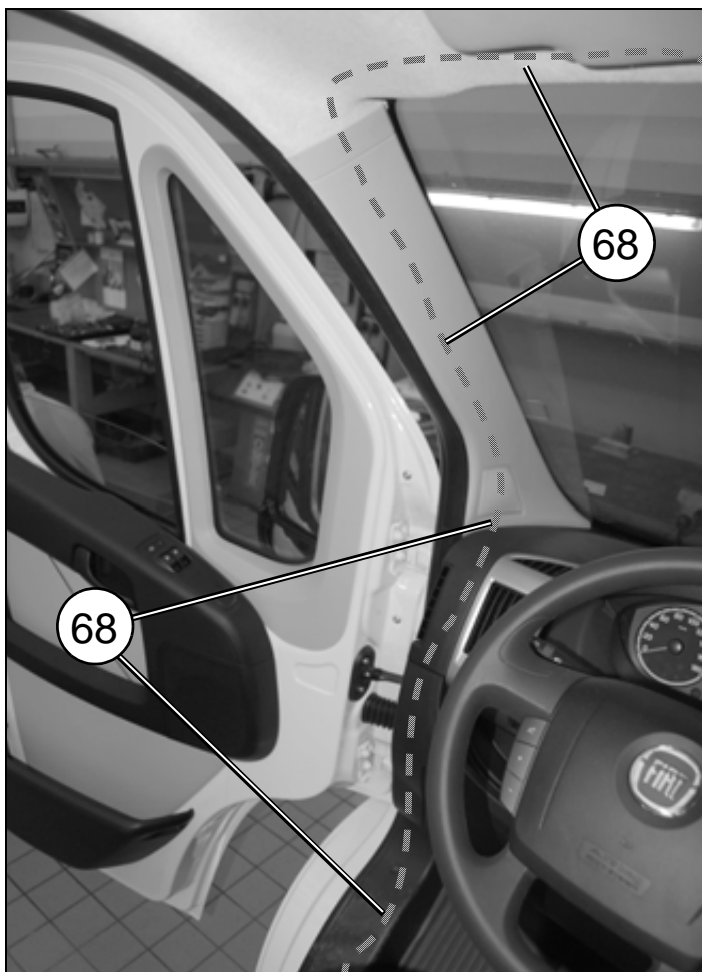

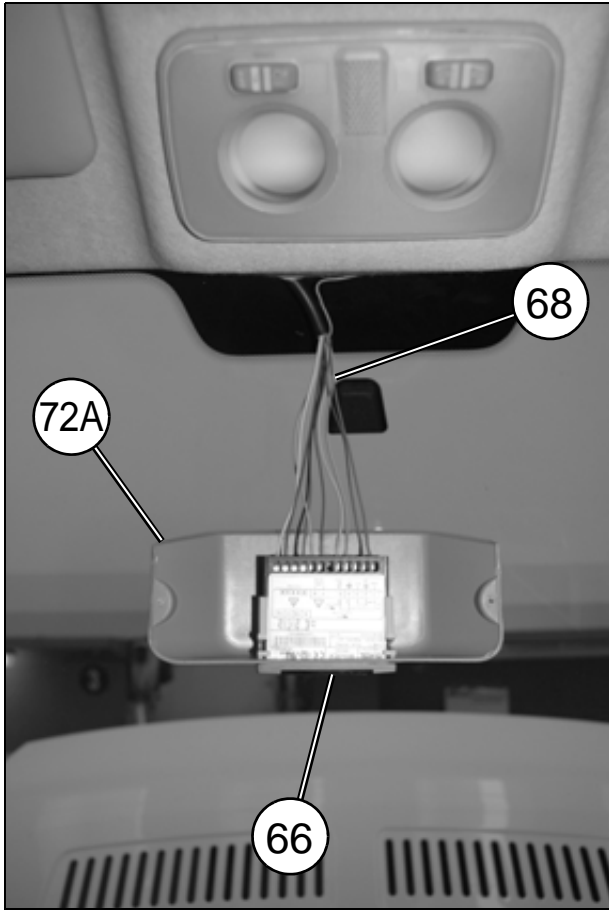

3E

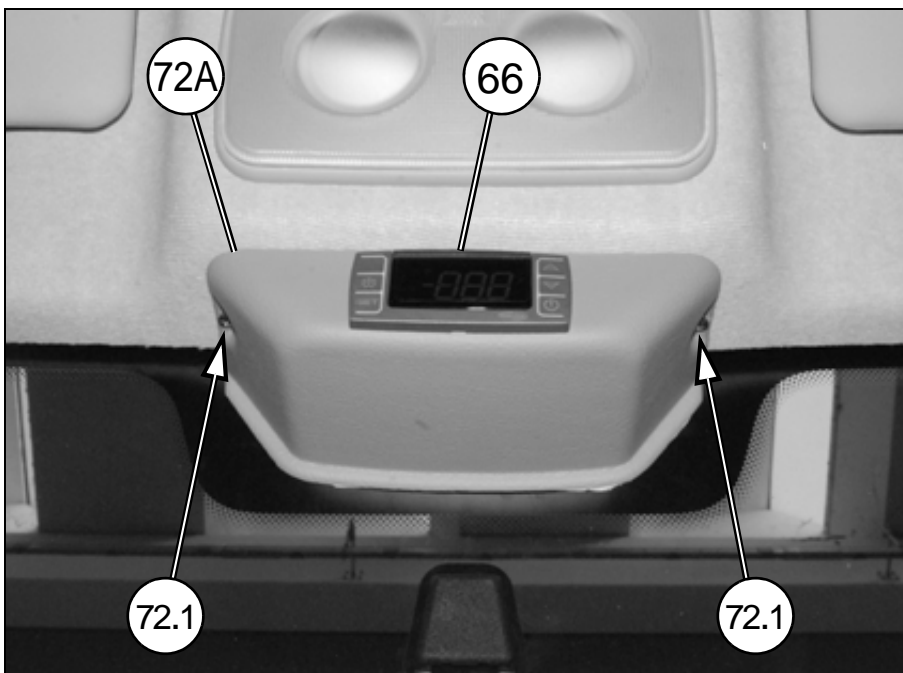
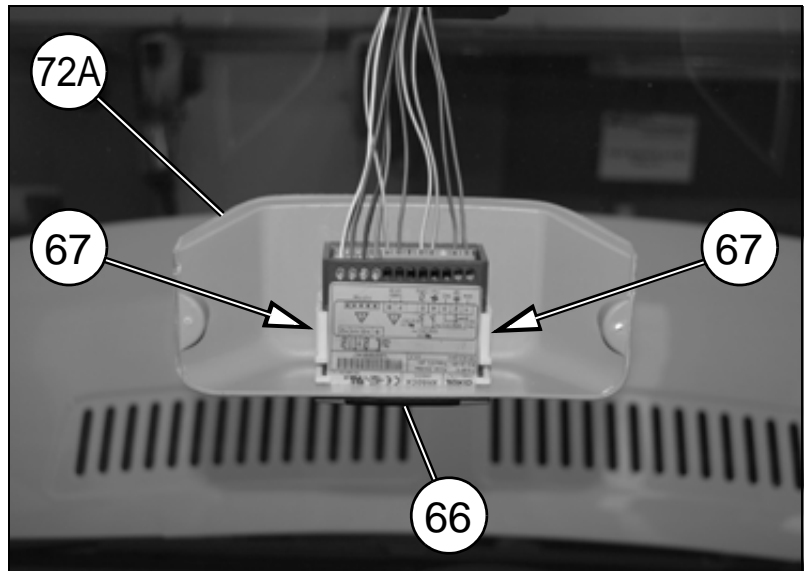

ELEMENTI DI FISSAGGIO PIECES DE FIXATION FIXING PARTS BEFESTIGUNGSELEMENTE ELEMENTOS DE FIJACION		
Pos.	Tipologia Typologie Typology Tipologie Tipologia	Descrizione Description Description Beschreibung Descripción
72.1		4 x 16

**COLLEGAMENTO TUBI GAS**  
**INSTALLAZIONE IMPIANTO ELETTRICO DIAVIA FRIGO E COMPONENTI ELETTRICI NEL VANO MOTORE**  
**RACCORDEMENT DES TUYAUX GAZ**  
**INSTALLATION FAISCEAU ELECTRIQUE DIAVIA FRIGO ET COMPOSANTS ELECTRIQUES DANS LE COMPARTIMENT MOTEUR**  
**GAS HOSES CONNECTION**  
**DIAVIA FRIGO ELECTRIC SYSTEM AND ELECTRIC COMPONENTS INSTALLATION IN THE ENGINE COMPARTMENT**  
**ANSCHLUSS DER KÄLTEMITTELSCHLÄUCHE**  
**EINBAU DER DIAVIA FRIGO-ELEKTROANLAGE UND DER ELEKTROBESTANDTEILE IM MOTORRAUM**  
**CONEXIÓN DE LOS TUBOS DEL GAS**  
**INSTALACIÓN ELÉCTRICA DIAVIA FRIGO Y LOS COMPONENTES ELÉCTRICOS EN EL COMPARTIMENTO DEL MOTOR**

**MATERIALE FORNITO / MATERIEL FOURNI / SUPPLIED MATERIAL / GELIEFERTES MATERIAL / MATERIAL ABASTECIDO**

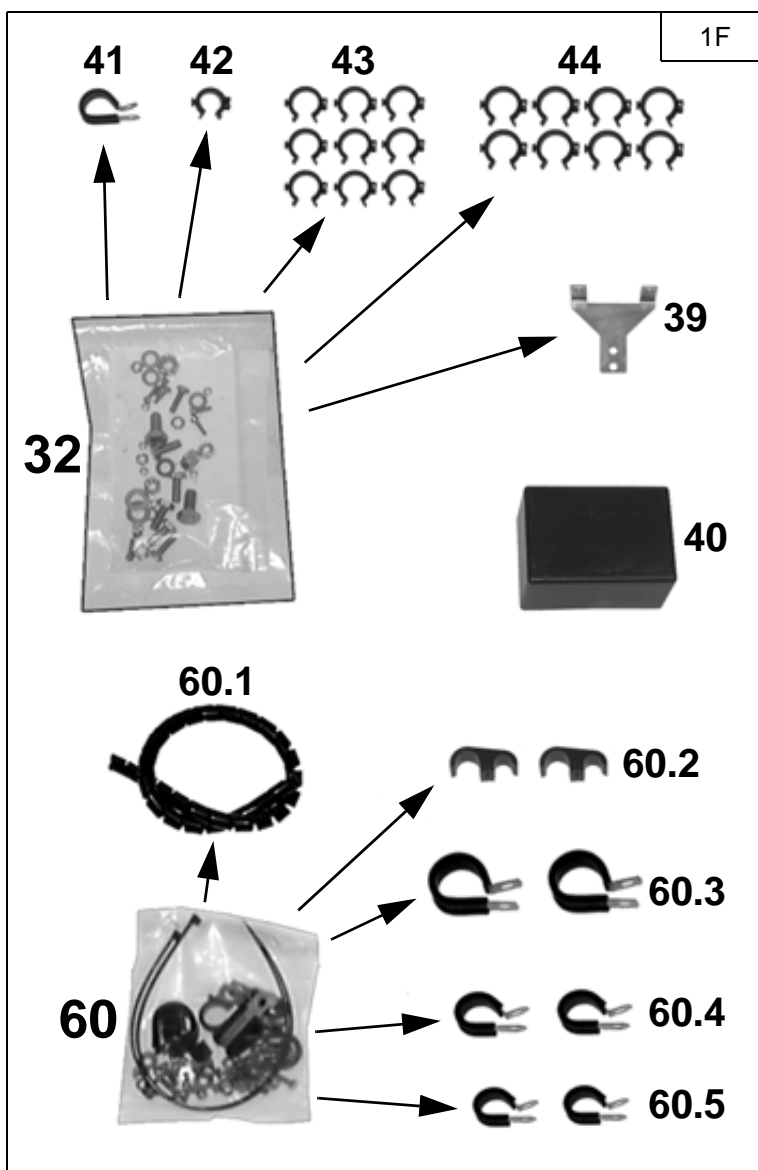

Pos.	Descrizione / Description / Description Beschreibung / Descripción	Codice / Code Kode / Código
35	Sacchetto accessori	0232108/0
39	Staffa ausiliaria di supporto Impianto elettrico elettroventole	0811266/0
40	Copri-relais	0361158/0
41	Fascetta in gomma	069032/0
42	Fermatubo $\phi 14 \times \phi 16$	069719/0
43	Fermatubo $\phi 18$	069635/0
44	Fermatubo $\phi 22$	069636/0
60	Sacchetto fissaggio tubi gas	0231621/0
60.1	Protezione a spirale	0701486/0
60.2	Fascetta fissatubo a 2 vie	069177/0
60.3	Fascetta in gomma	069241/1
60.4	Fascetta in gomma	069033/0
60.5	Fascetta in gomma	069032/0

MATERIALE FORNITO / MATERIEL FOURNI / SUPPLIED MATERIAL / GELIEFERTES MATERIAL / MATERIAL ABASTECIDO

**0282458/0**

2F

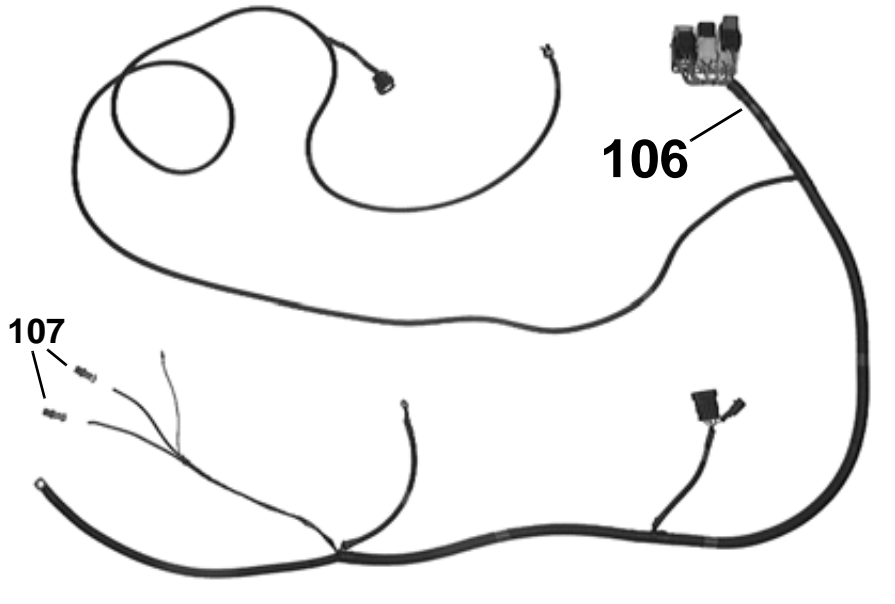

Pos.	Descrizione / Description Description / Beschreibung Descripción	Codice / Code Kode / Código
106	Impianto elettrico Elettroventole	0282458/0
107	Terminale	-
108	Prolunga cavi per compressore	0282469/0

**0282469/0**

**108**

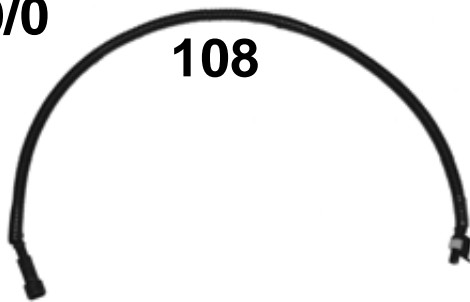

**0282343/1**

2.1F

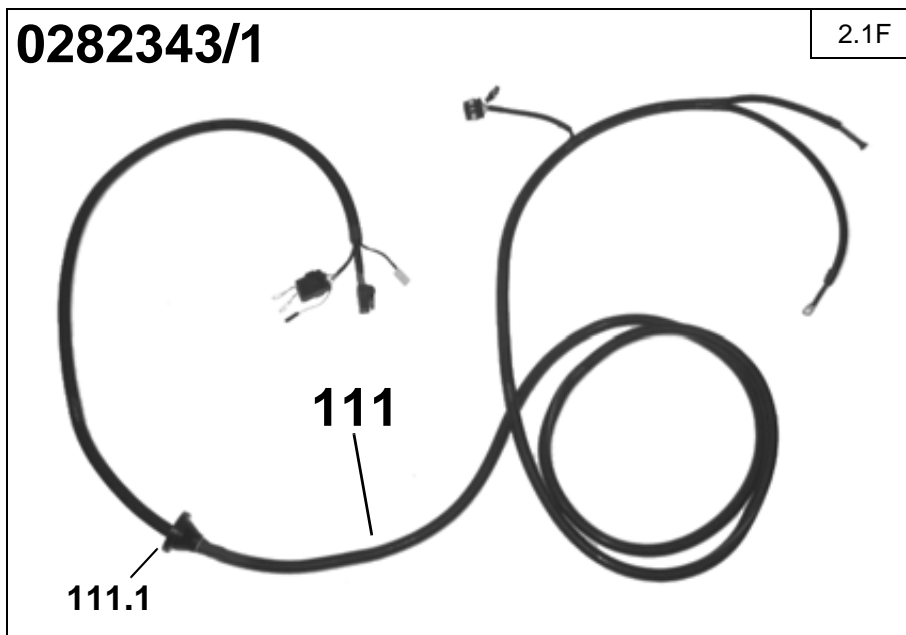

Pos.	Descrizione / Description Description / Beschreibung Descripción	Codice / Code Kode / Código
111	Impianto elettrico intermedio	0282343/1
111.1	Gommino passacavi	069109/0

MATERIALE FORNITO / MATERIEL FOURNI / SUPPLIED MATERIAL / GELIEFERTES MATERIAL / MATERIAL ABASTECIDO

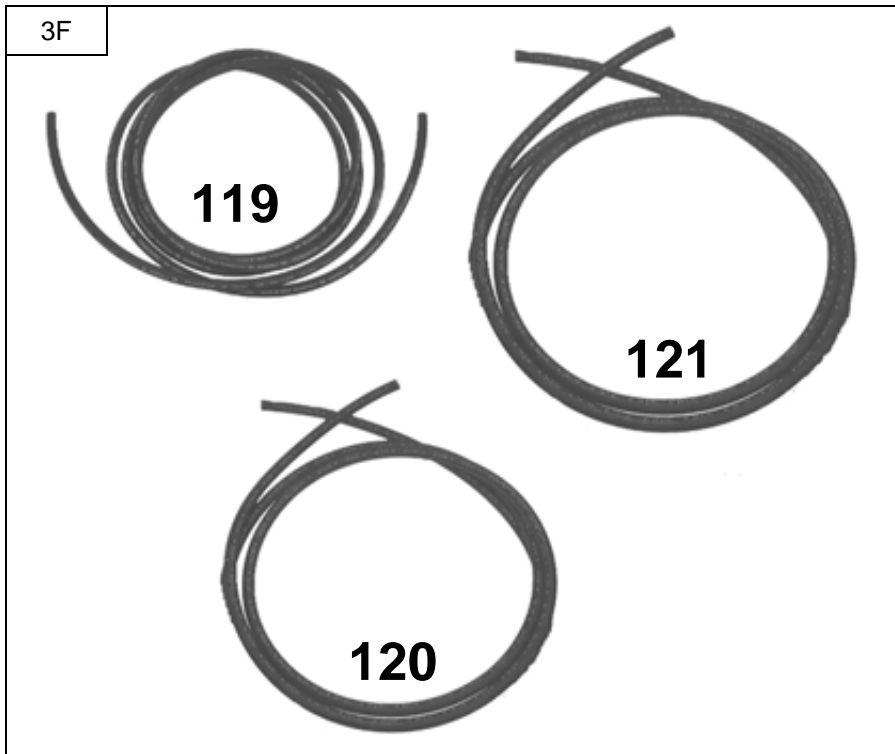

Pos.	Descrizione / Description Description / Beschreibung Descripción	Codice / Code Code / Código
54	Sacchetto accessori per separatore olio	0231654/0
118	Sacchetto raccordi	0232107/0
119	Tubo gas 5/16"	90006G2GRFR.2
120	Tubo gas 13/32"	90008G2GRFR.7
121	Tubo gas 1/2"	90010G2GRFR.1
122	Fascetta per raccordi tubi gas 5/16"	0361778/0
123	Fascetta per raccordi tubi gas 13/32"	0361779/0
124	Fascetta per raccordi tubi gas 1/2"	0361780/0
125	Raccordo tubo gas 5/16"	80106FS002/1
126	Raccordo tubo gas 5/16"	80106FS020
128	Raccordo tubo gas 5/16"	80106FS001/1
129	Raccordo tubo gas 5/16"	80106FS004/1
130	Raccordo tubo gas 13/32"	80108FS003/1
131	Raccordo tubo gas 13/32"	80108FS015
132	Raccordo tubo gas 13/32"	80108FS012
133	Raccordo tubo gas 13/32"	80108FS010
134	Raccordo tubo gas 1/2"	80110FS010
135	Raccordo tubo gas 1/2"	80110FS028
136	Raccordo tubo gas 1/2"	80110FS069
★	<b>Da non utilizzare nella presente installazione</b> <b>A ne pas utiliser dans cette installation</b> <b>Not to be used in this installation</b> <b>Nicht folgeden Einbau zu verwenden</b> <b>No hay que usar en la presente instalación</b>	

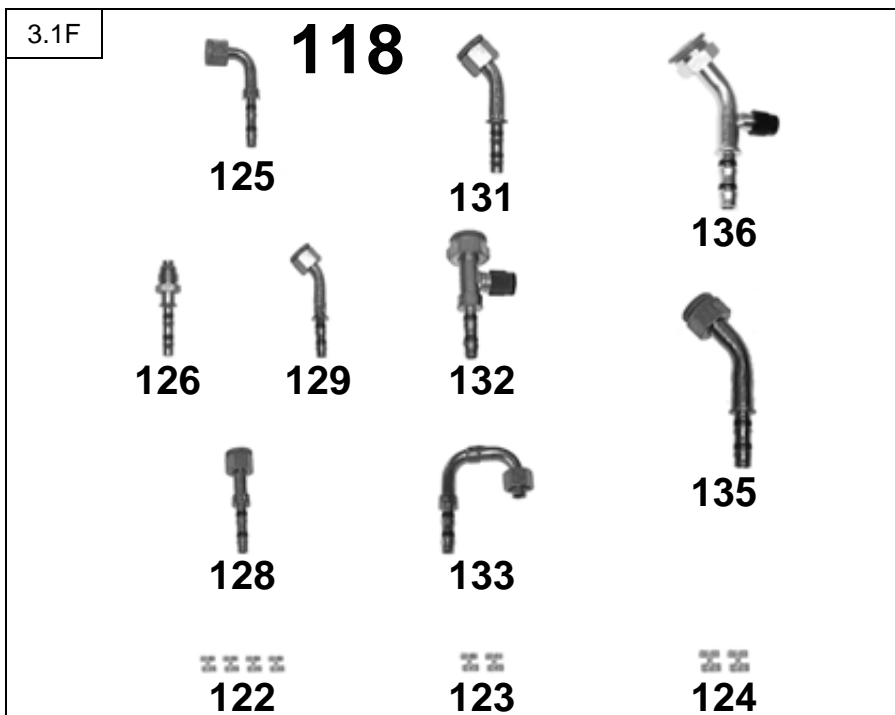

**POSIZIONAMENTO IMPIANTO ELETTRICO NEL VANO MOTORE (vedi schema elettrico allegato)**  
**POSITIONNEMENT DU FAISCEAU ELECTRIQUE DANS LE COMPARTIMENT MOTEUR (voir schéma électrique joint)**  
**POSITIONING THE ELECTRIC SYSTEM WIRING WITHIN THE ENGINE COMPARTMENT (see the enclosed wiring diagram)**  
**POSITIONIERUNG DER ELEKTRISCHEN ANLAGE IM MOTORRAUM (siehe Schaltschema im Anhang)**  
**COLOCACIÓN DE LA INSTALACIÓN ELÉCTRICA EN EL ESPACIO MOTOR (véase esquema eléctrico adjunto)**

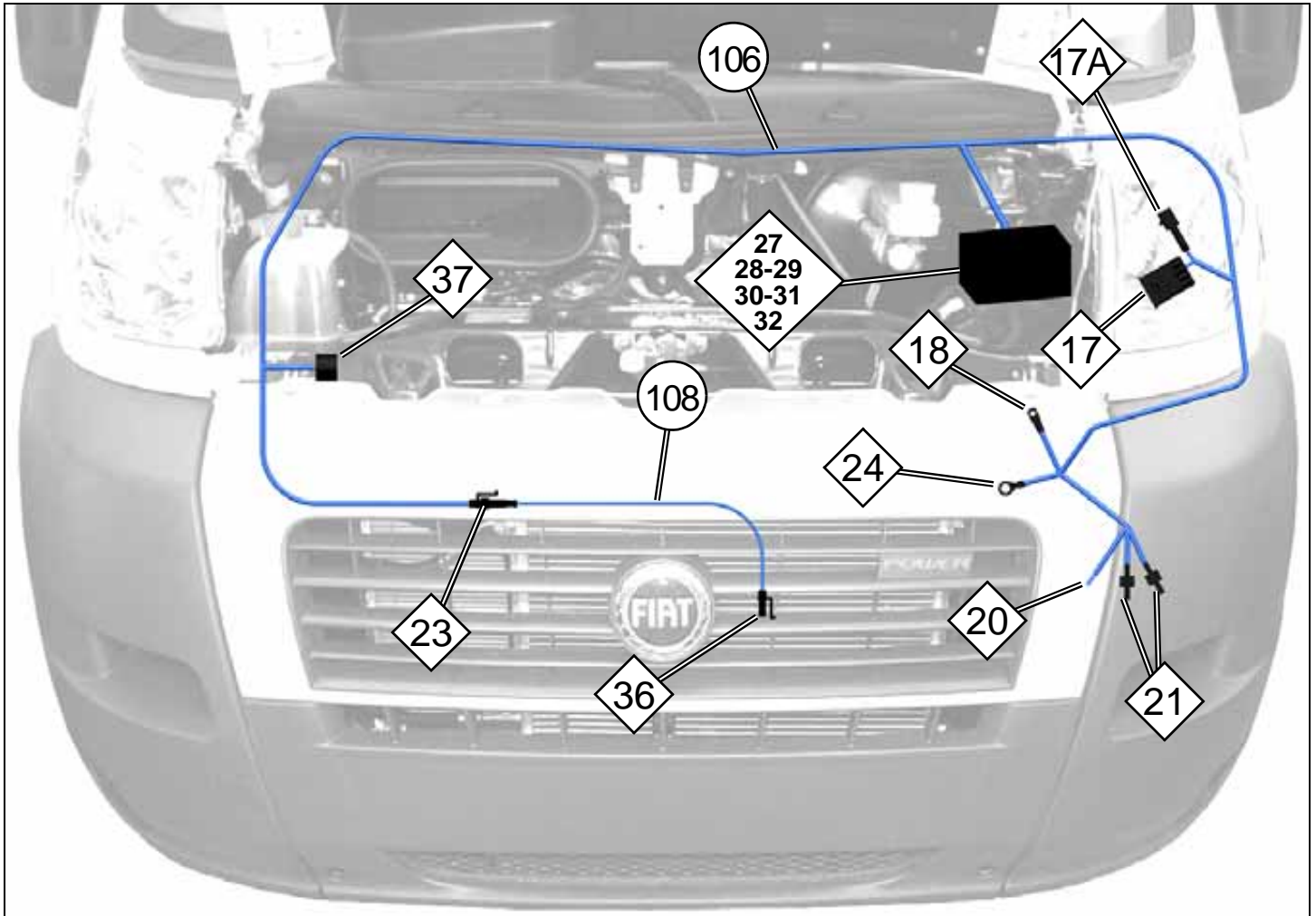

4F

106 → **0282458/0**

108 → **0282469/0**

**VEDI Fig. 5F-6F-7F-8F-9F**  
**VOIR Fig. 5F-6F-7F-8F-9F**  
**SEE Fig. 5F-6F-7F-8F-9F**  
**SIEHE Abb. 5F-6F-7F-8F-9F**  
**VÉASE Fig. 5F-6F-7F-8F-9F**

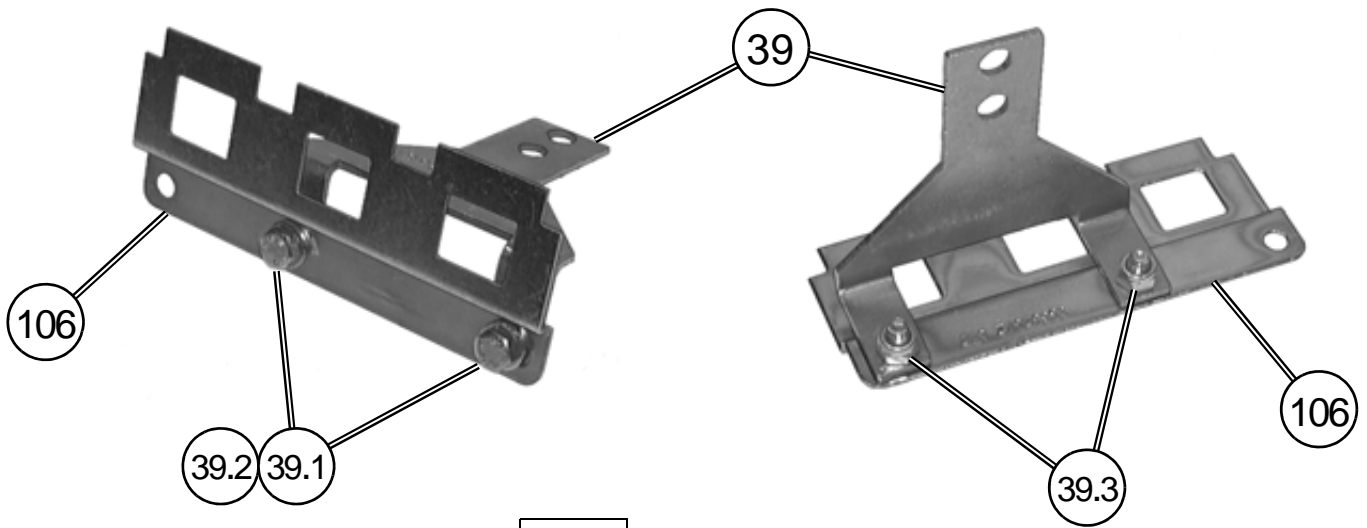

5F

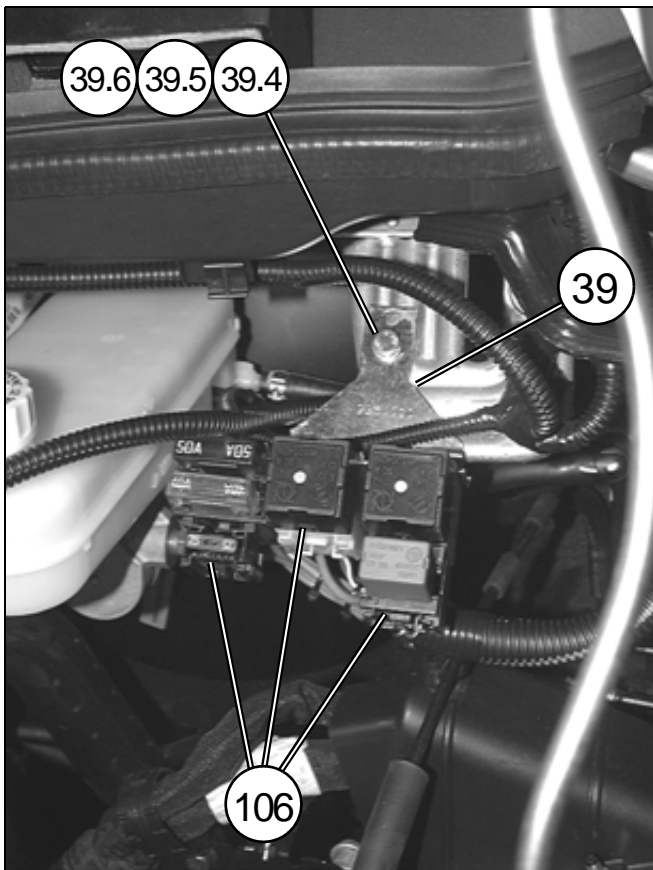

ELEMENTI DI FISSAGGIO / PIECES DE FIXATION FIXING PARTS / BEFESTIGUNGSELEMENTE ELEMENTOS DE FIJACION		
Pos.	Tipologia / Typologie Typology / Tipologie Tipologia	Descrizione / Description Description / Beschreibung Descripción
39.1		M5 x 12
39.2		φ 5
39.3		M5
39.4		M6 x 16
39.5		φ 6
39.6		M6

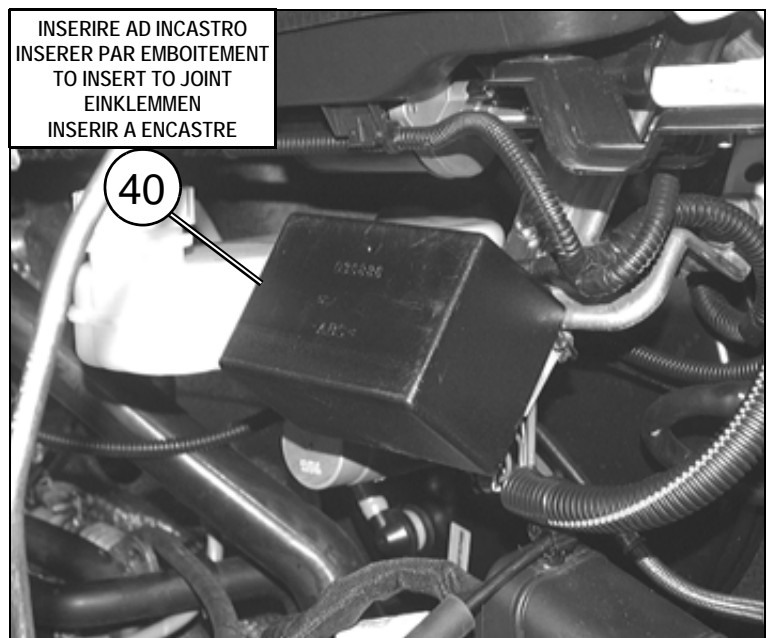



6F

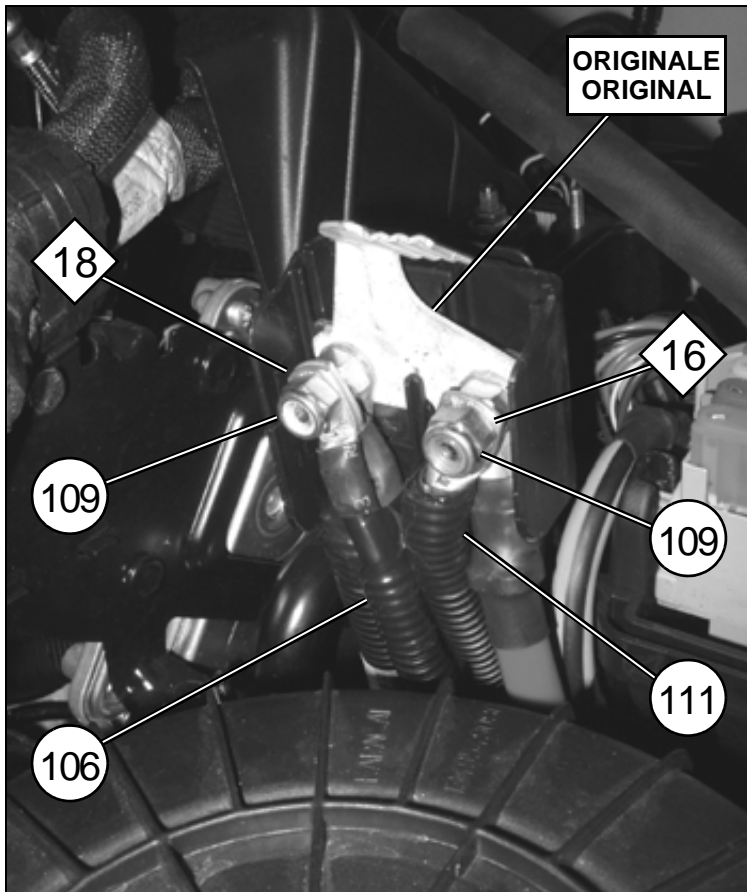
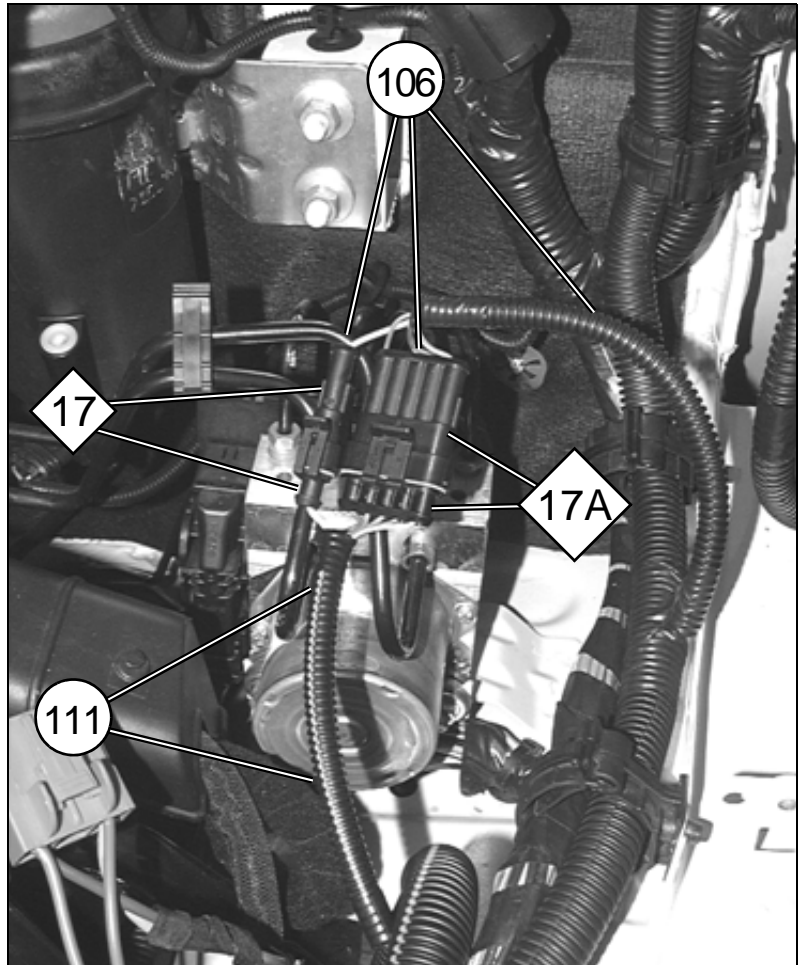

7F

ELEMENTI DI FISSAGGIO / PIECES DE FIXATION FIXING PARTS / BEFESTIGUNGSELEMENTE ELEMENTOS DE FIJACION		
Pos.	Tipologia / Typologie Typology / Tipologie Tipologia	Descrizione / Description Description / Beschreibung Descripción
109		M8

ELIMINARE  
ELIMINER  
DISCARD  
ENTFERNEN  
ELIMINAR

ORIGINALI  
ORIGINALS

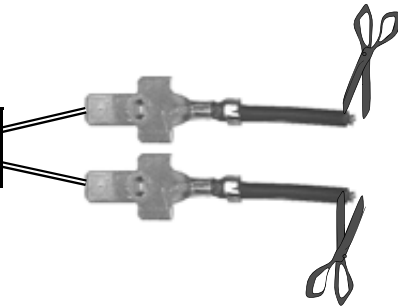

8F

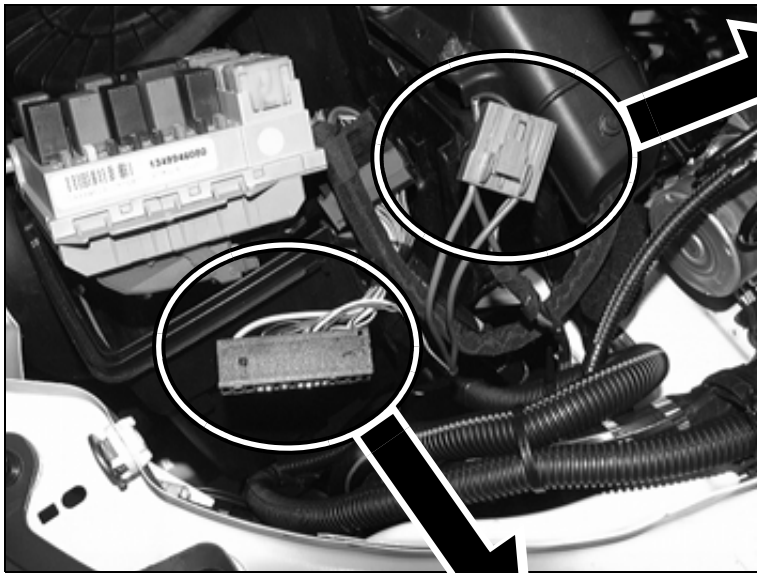
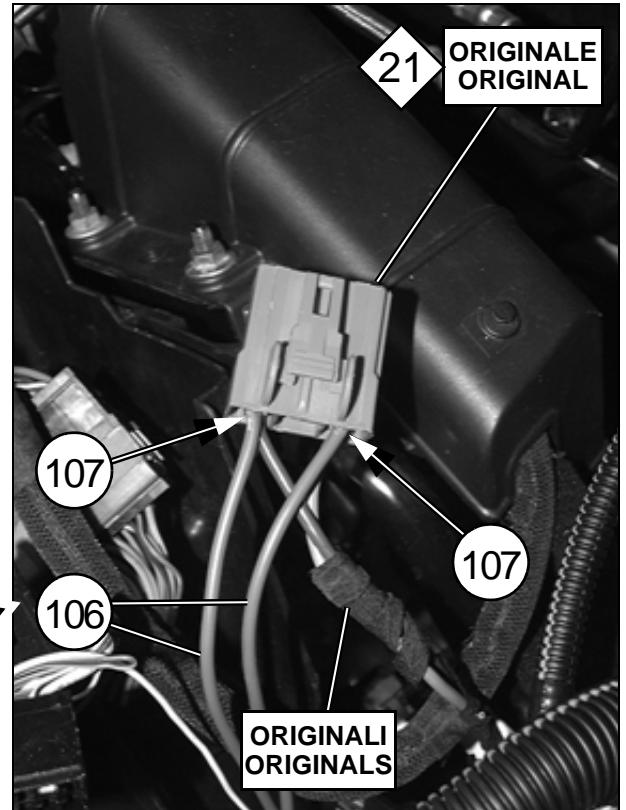

SMONTARE  
DEMONTER  
REMOVE  
AUSBAUEN  
DESMONTAR

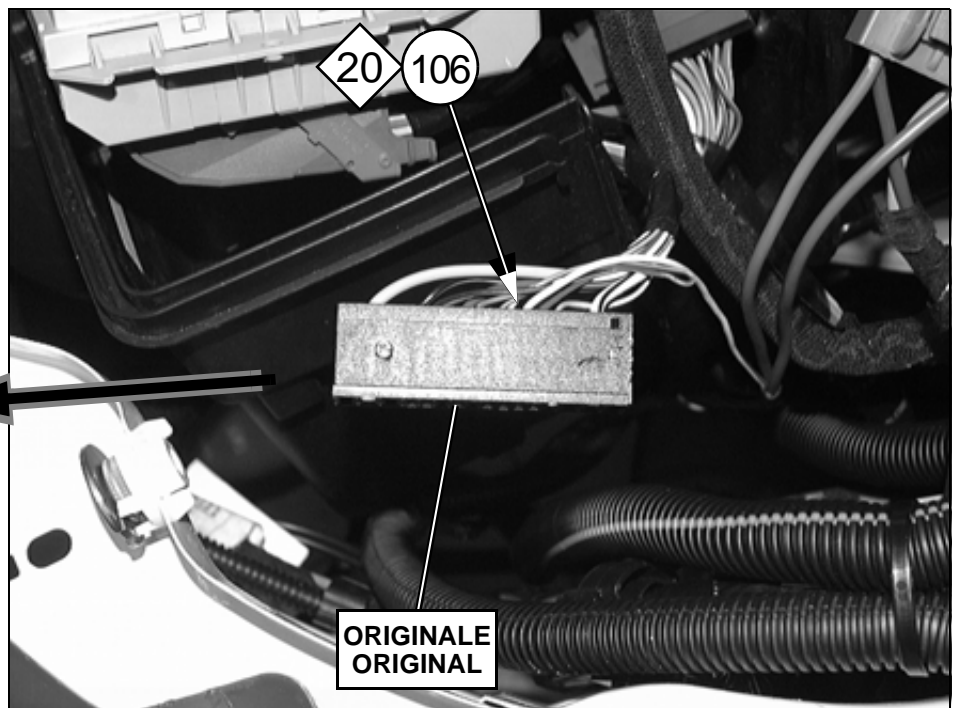

9F

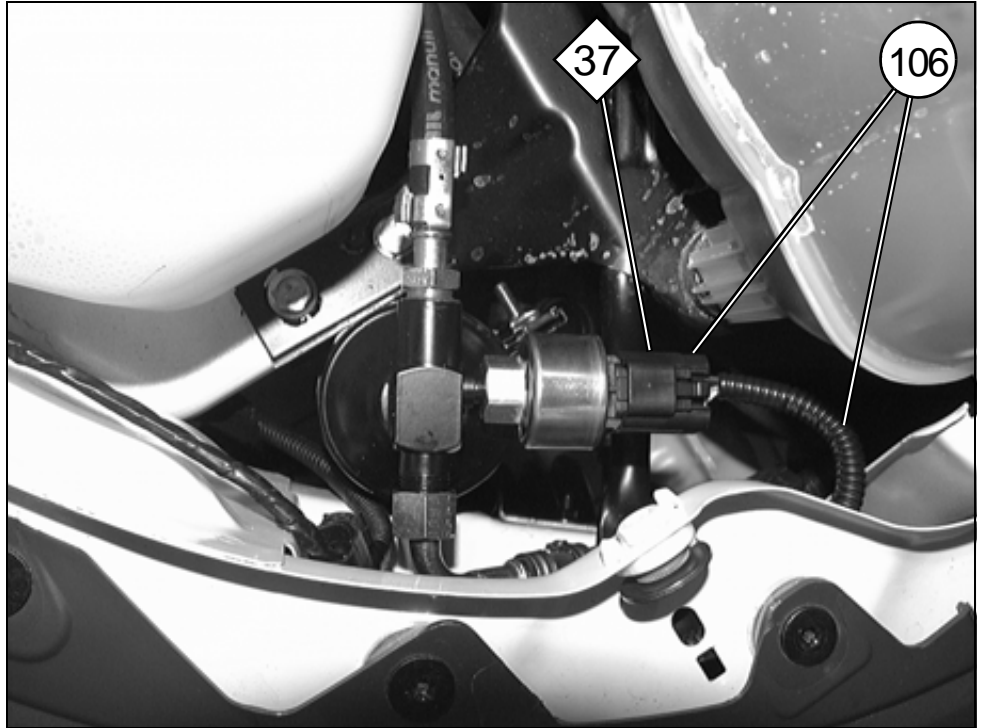

SCHEMA COLLEGAMENTO TUBI GAS E CIRCOLAZIONE FLUIDO REFRIGERANTE  
 SCHEMA CONNEXION TUYAUX GAZ ET CIRCULATION FLUIDE REFRIGERANT  
 DIAGRAM OF GAS AND REFRIGERANT CIRCULATION HOSE CONNECTIONS  
 VERBINDUNGSSCHEMA DER KÄLTEMITTELSCHLÄUCHE UND DES KÜHLMITTELUMLAUF  
 ESQUEMA CONEXIÓN TUBOS GAS Y CIRCULACIÓN FLUIDO REFRIGERANTE

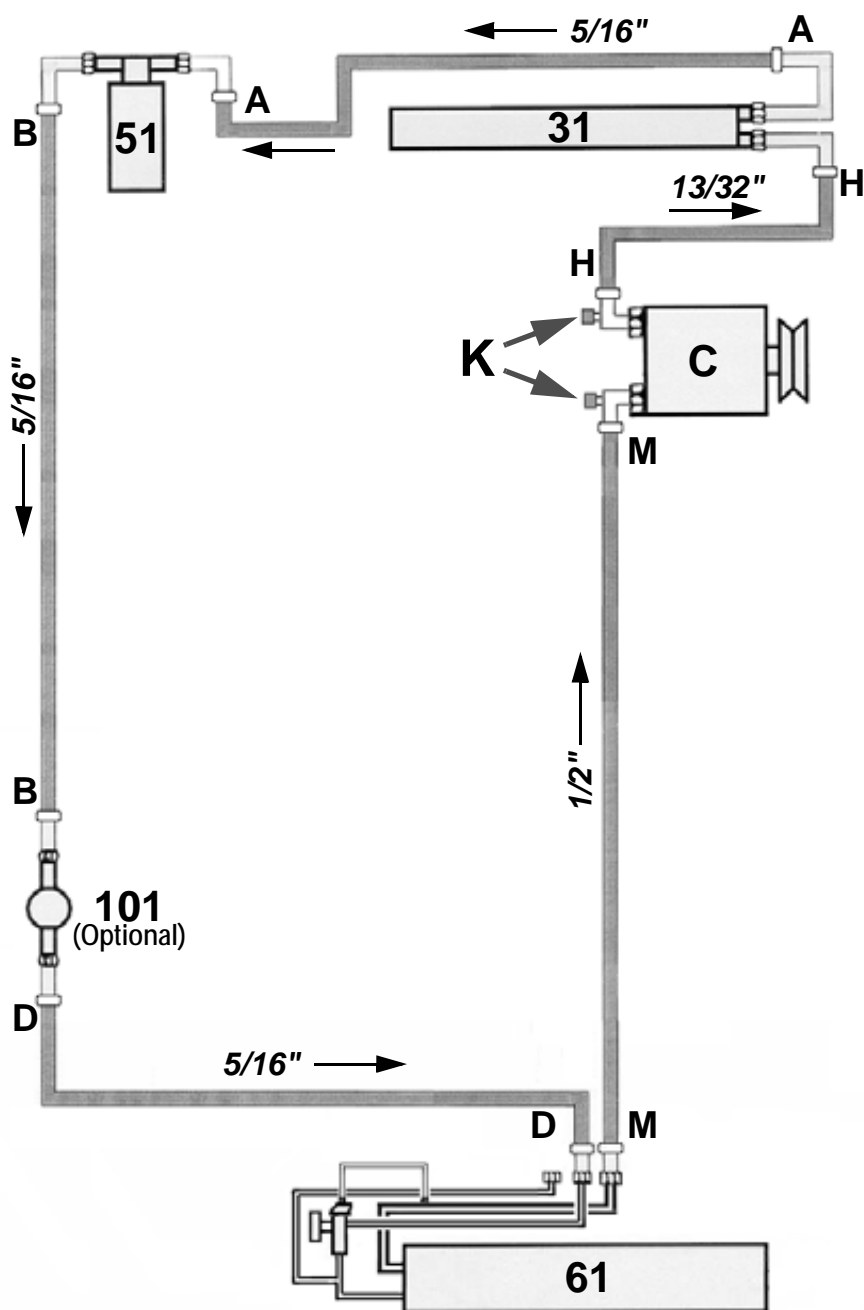

<b>C</b>	Compressore
<b>31</b>	Condensatore
<b>51</b>	Filtro essiccatore
<b>61</b>	Gruppo refrigerante
<b>101</b>	Indicatore passaggio liquido e umidità (Optional Kit)

<b>A</b>	Tubo gas 5/16"
<b>B</b>	Tubo gas 5/16"
<b>D</b>	Tubo gas 5/16"
<b>H</b>	Tubo gas 13/32"
<b>M</b>	Tubo gas 1/2"
<b>K</b>	Raccordo con punto di carica

10F

**R134a**



**Kg.1,300 (±0,025)**

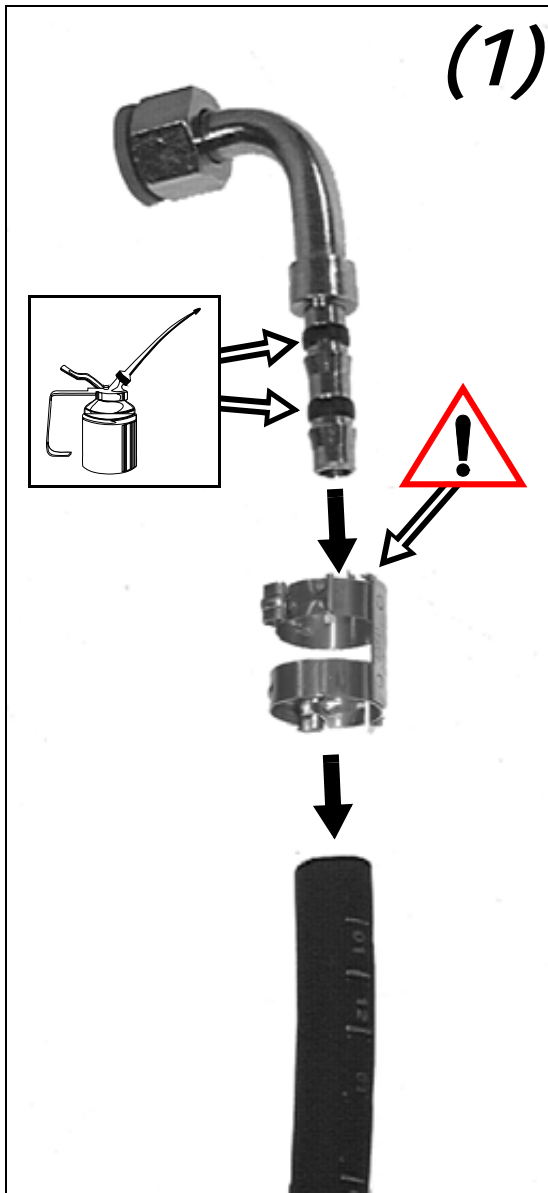

(1)

(I) PROCEDURA PER IL BLOCCAGGIO DI TUTTI I TUBI GAS AI RACCORDI

(1) Oliare O.R.; innestare raccordo nel tubo alloggiando la fascetta con la linguetta di battuta nella posizione di figura (2); bloccare con apposita pinza la fascetta nei due punti (3).

(F) PROCEDURE POUR LA FIXATION DE TOUS LES TUYAUX GAZ AUX RACCORDS

(1) Huiler O.R.: emboîter le raccord dans le tuyau et loger le collier avec la languette de contact comme indiqué sur la figure (2); fixer à l'aide de la pince appropriée aux deux points (3).

(GB) PROCEDURE FOR LOCKING ALL GAS HOSES TO THE CONNECTIONS

(1) Oil the O-ring; snap the connection into the hose, positioning the clamp with the tab flush in the position indicated in the figure (2); lock the clamp in place at two points using the special pliers (3).

11F

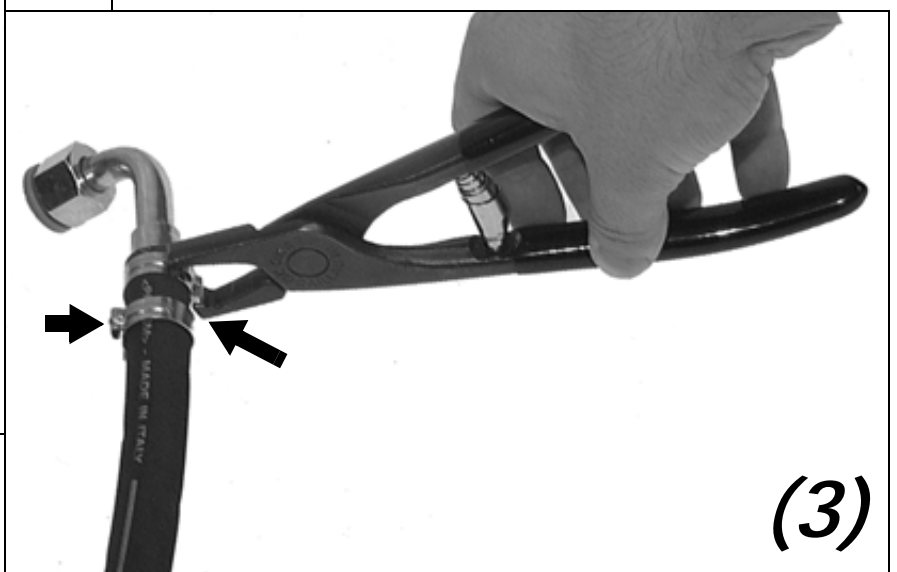

(3)

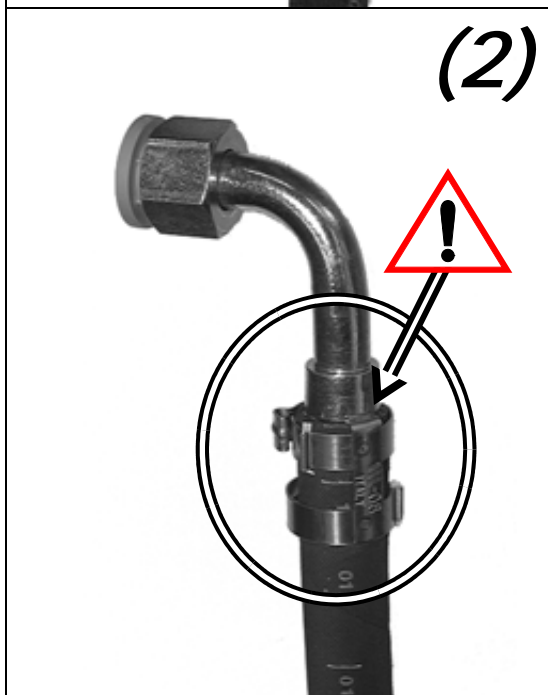

(2)

(D) BLOCKIERUNGSVERFAHREN ALLER KÜHLMITTELSCHLÄUCHE AN DEN VERBINDUNGSSTÜCKEN

(1) O.R.Ring ölen: Verbindungsstück an Schlauch ankuppeln und die Schelle mit dem Anschlag des Betätigungshebels in gezeigter Position anbringen (2): mit entsprechender Zange die Schelle in den beiden Punkten festziehen (3).

(E) PROCEDIMIENTO PARA LA FIJACIÓN DE TODOS LOS TUBOS A LOS RACORES



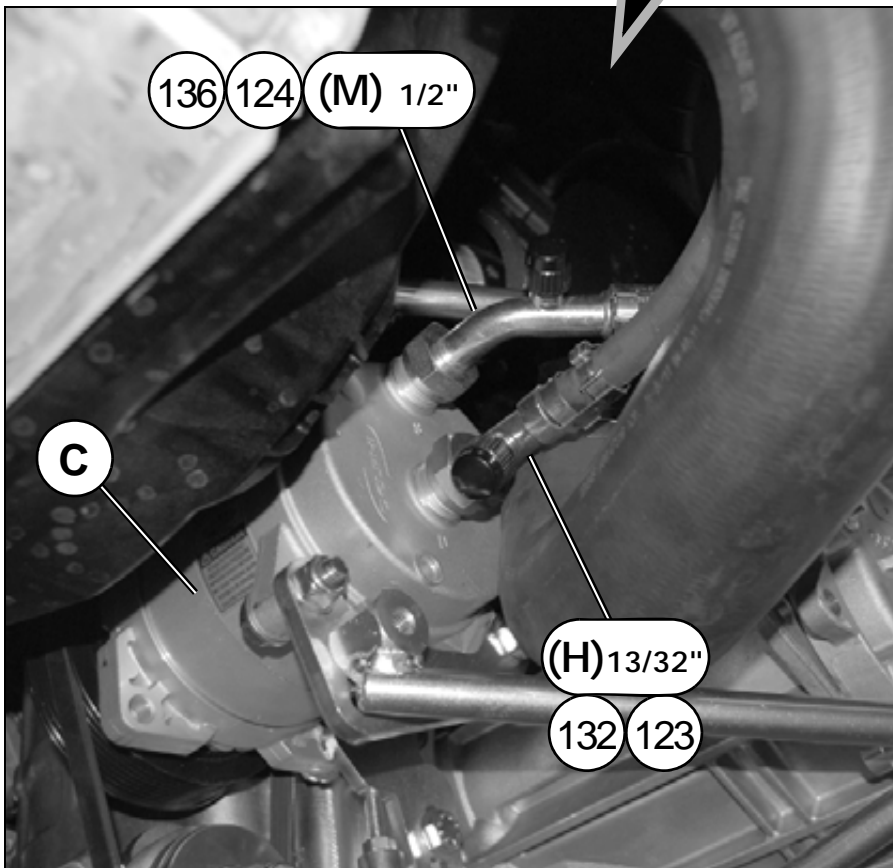
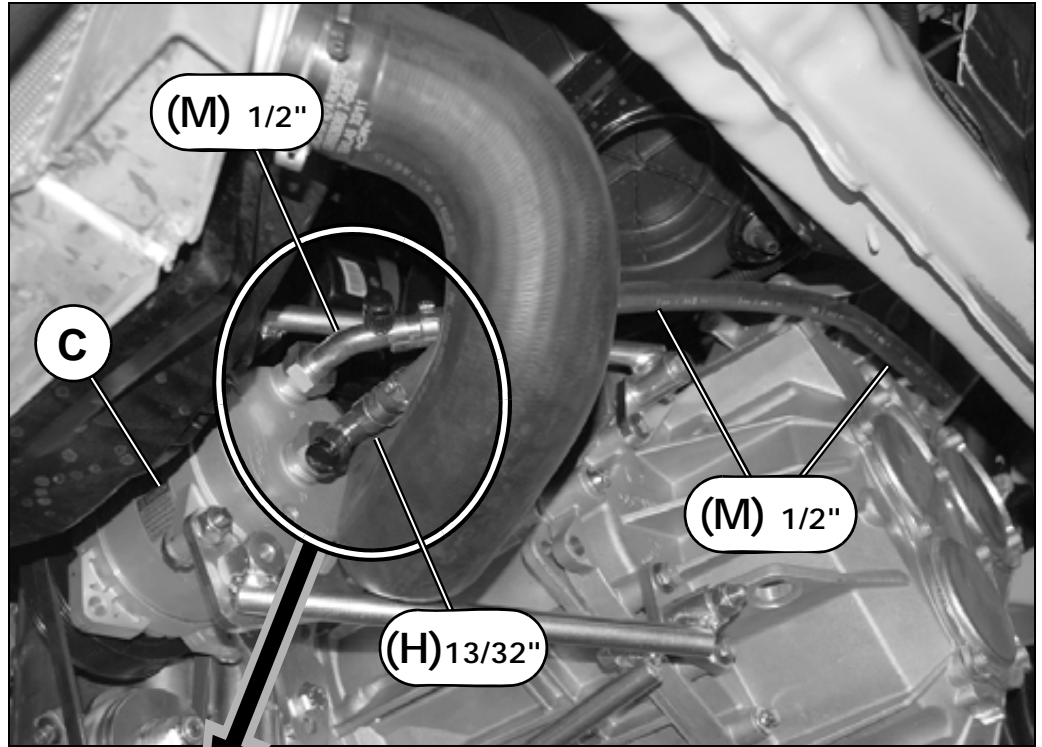

(1) Lubricar O.R., insertar el racor en el tubo colocando la banda con la lengüeta de golpe en la posición de figura (2); bloquear la banda en los dos puntos con pinza apropiada (3).

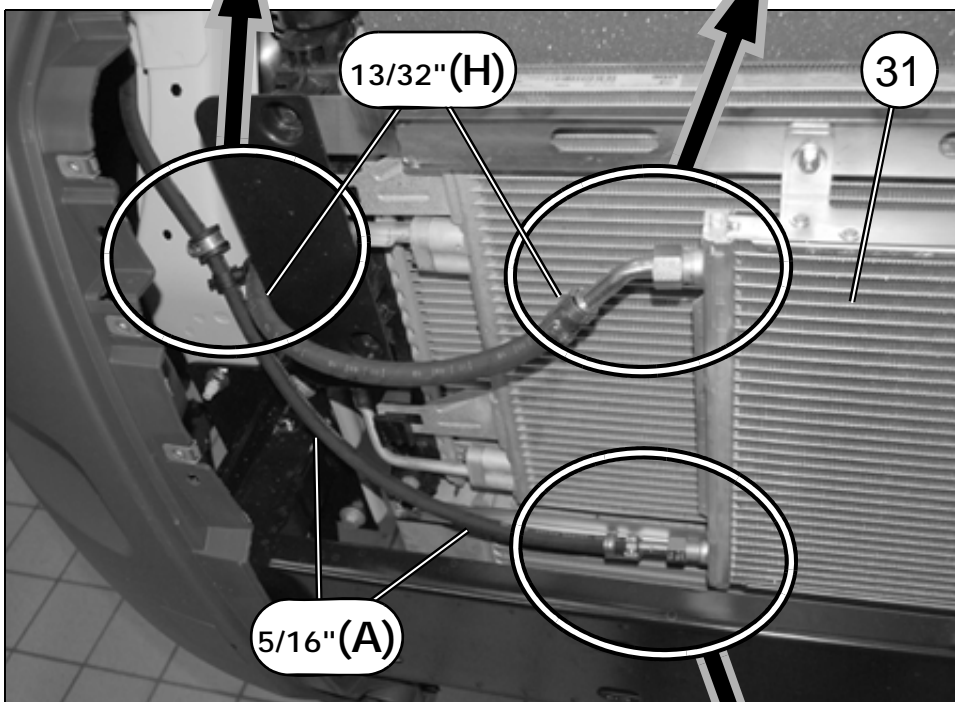
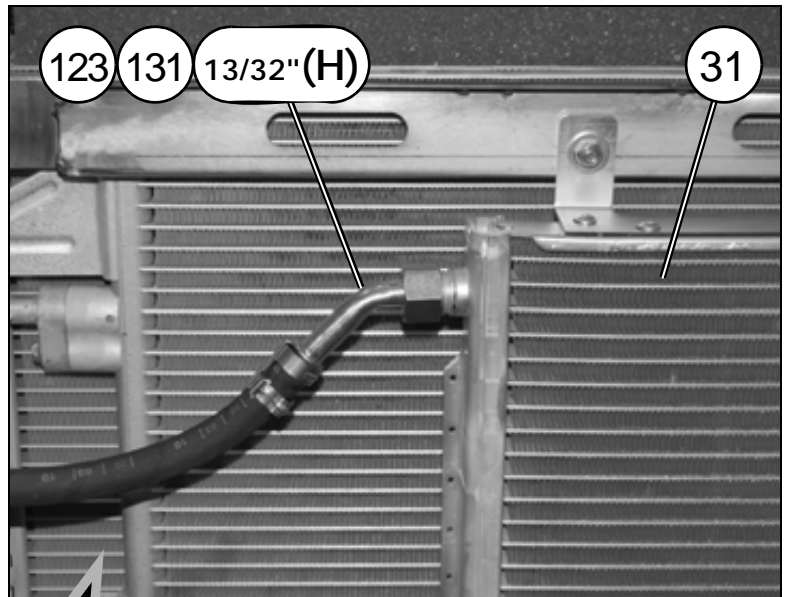
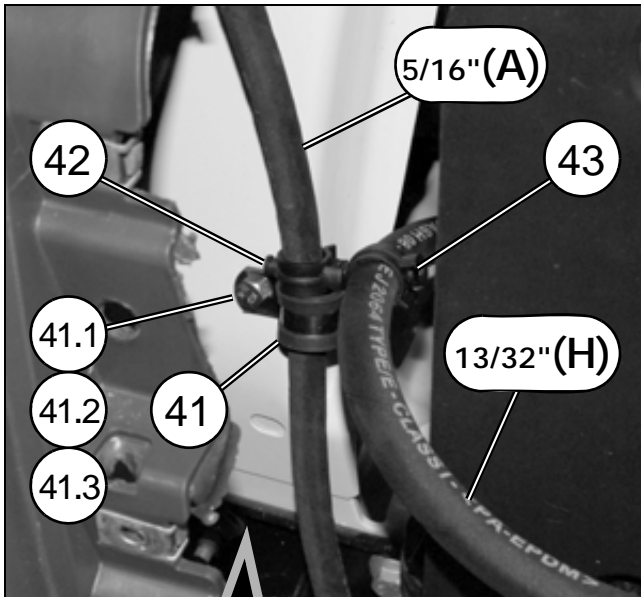

12F

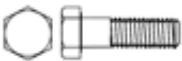

13F

ELEMENTI DI FISSAGGIO / PIÈCES DE FIXATION FIXING PARTS / BEFESTIGUNGSELEMENTE ELEMENTOS DE FIJACION		
Pos.	Tipologia / Typologie Typology / Tipologie Tipologia	Descrizione / Description Description / Beschreibung Descripción
41.1		M6 x 16
41.2		φ 6
41.3		M6
42		Fermatubo φ 18
43		Fermatubo φ 24

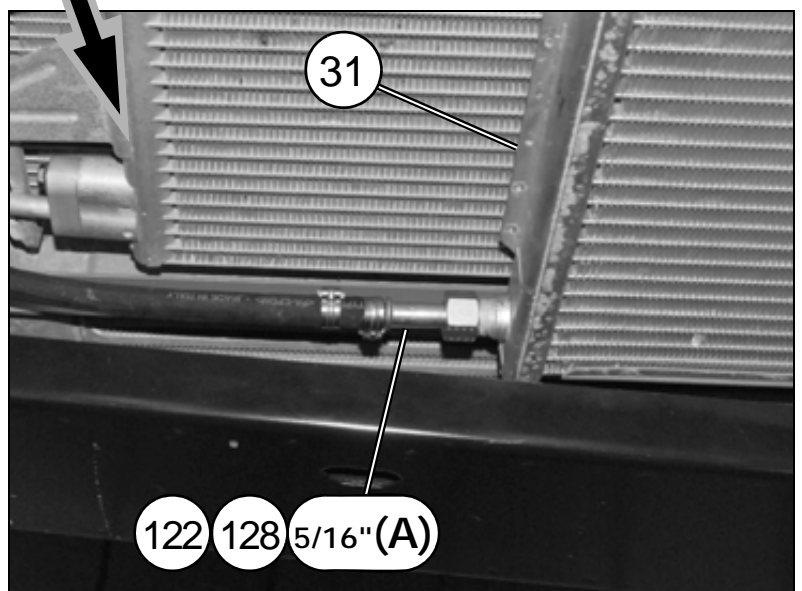

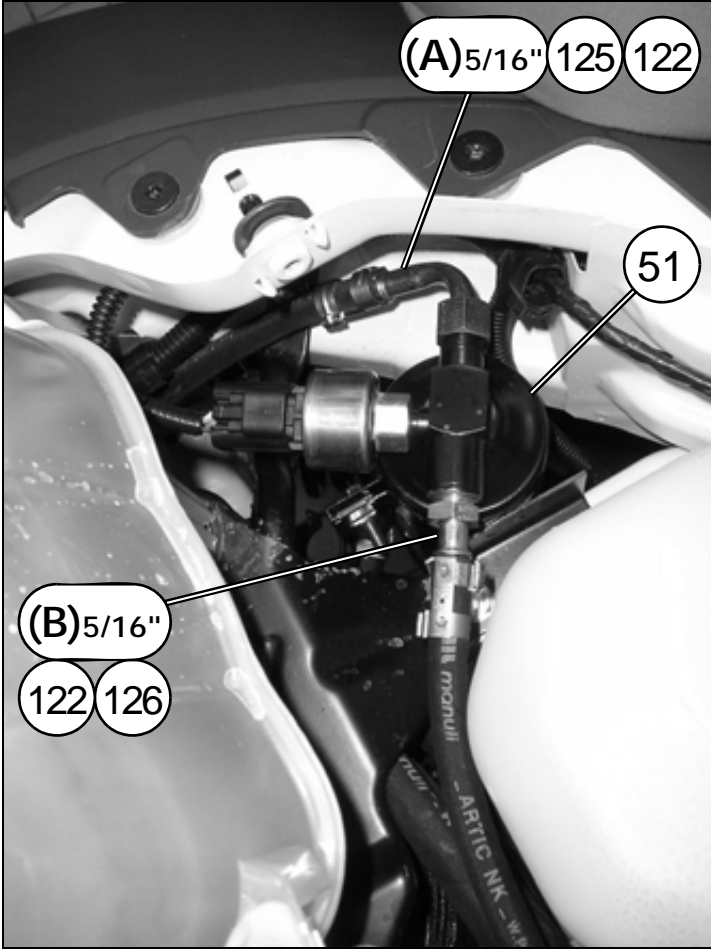

14F



SCHEMA COLLEGAMENTO TUBI GAS E CIRCOLAZIONE FLUIDO REFRIGERANTE  
 SCHEMA CONNEXION TUYAUX GAZ ET CIRCULATION FLUIDE REFRIGERANT  
 DIAGRAM OF GAS AND REFRIGERANT CIRCULATION HOSE CONNECTIONS  
 VERBINDUNGSSCHEMA DER KÄLTEMITTELSCHLÄUCHE UND DES KÜHLMITTELUMLAUFS  
 ESQUEMA CONEXIÓN TUBOS GAS Y CIRCULACIÓN FLUIDO REFRIGERANTE

+ OPTIONAL KIT

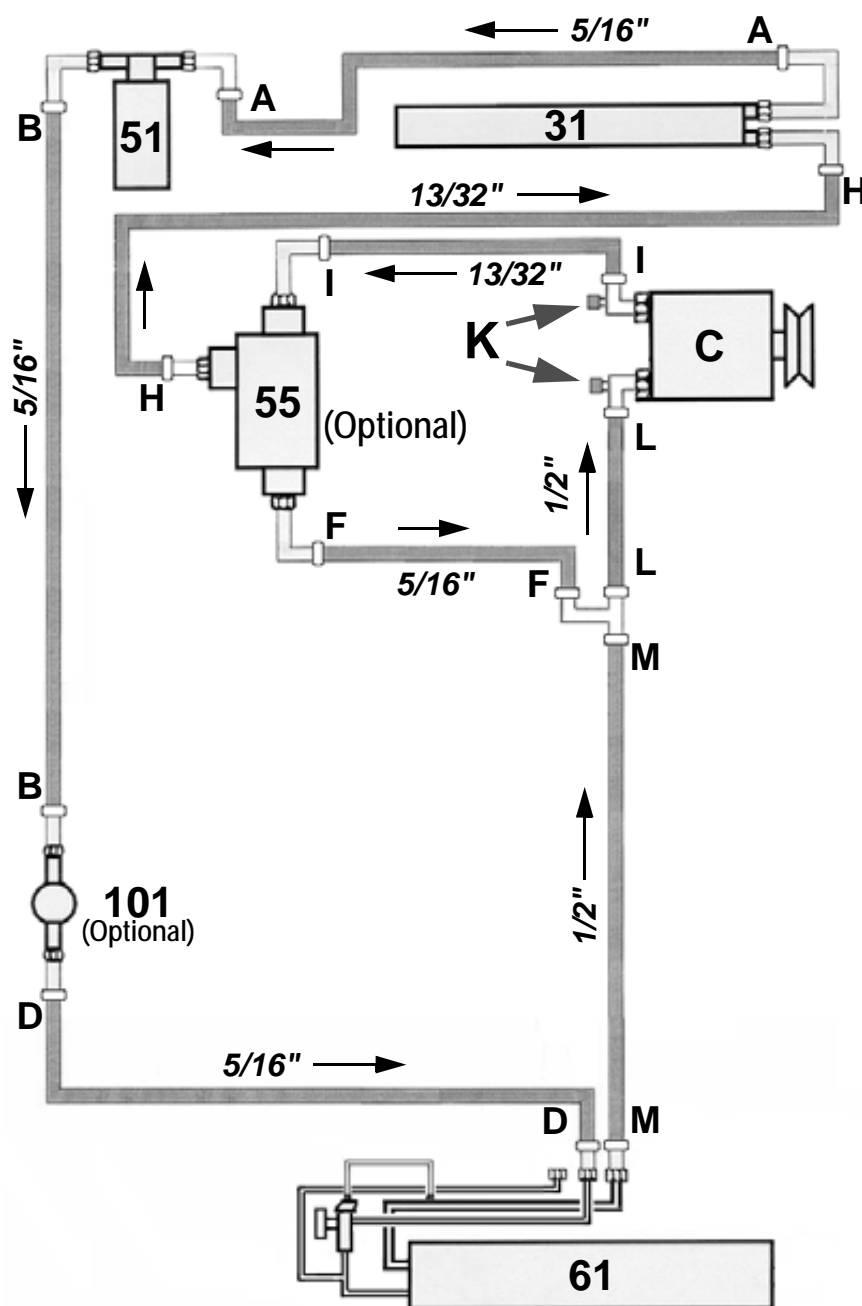

<b>C</b>	Compressore
<b>31</b>	Condensatore
<b>51</b>	Filtro essiccatore
<b>55</b>	Separatore olio (Optional Kit)
<b>61</b>	Gruppo refrigerante
<b>101</b>	Indicatore passaggio liquido e umidità (Optional Kit)

<b>A</b>	Tubo gas 5/16"
<b>B</b>	Tubo gas 5/16"
<b>D</b>	Tubo gas 5/16"
<b>F</b>	Tubo gas 5/16"
<b>H</b>	Tubo gas 13/32"
<b>I</b>	Tubo gas 13/32"
<b>L</b>	Tubo gas 1/2"
<b>M</b>	Tubo gas 1/2"
<b>K</b>	Raccordo con punto di carica

15F

**R134a**



**Kg.1,300 (±0,025)**

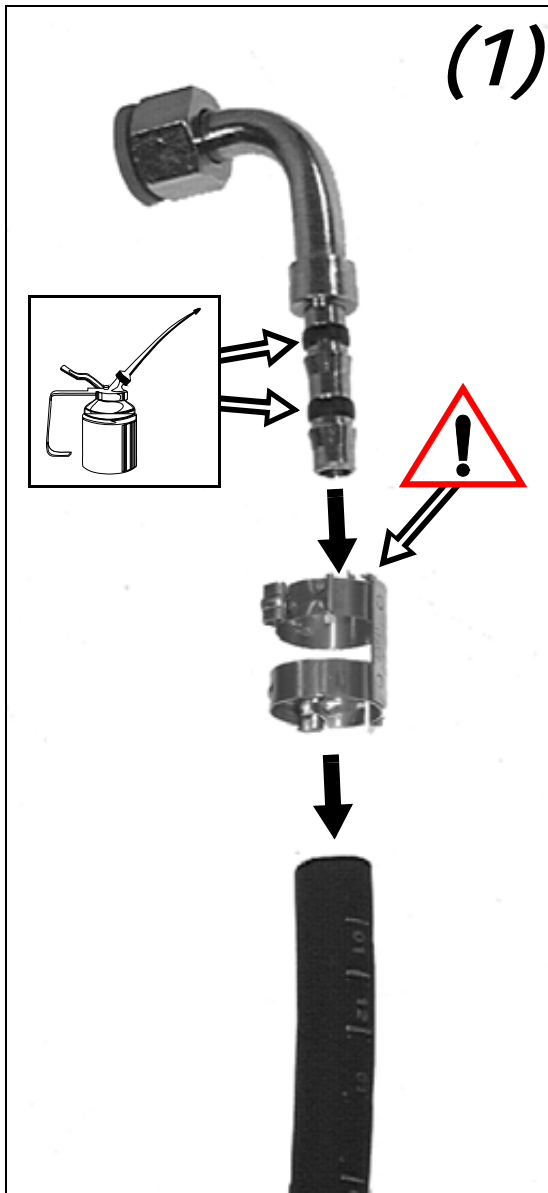

(1)

(I) PROCEDURA PER IL BLOCCAGGIO DI TUTTI I TUBI GAS AI RACCORDI

(1) Oliare O.R.; innestare raccordo nel tubo alloggiando la fascetta con la linguetta di battuta nella posizione di figura (2); bloccare con apposita pinza la fascetta nei due punti (3).

(F) PROCEDURE POUR LA FIXATION DE TOUS LES TUYAUX GAZ AUX RACCORDS

(1) Huiler O.R.; emboîter le raccord dans le tuyau et loger le collier avec la languette de contact comme indiqué sur la figure (2); fixer à l'aide de la pince appropriée aux deux points (3).

(GB) PROCEDURE FOR LOCKING ALL GAS HOSES TO THE CONNECTIONS

(1) Oil the O-ring; snap the connection into the hose, positioning the clamp with the tab flush in the position indicated in the figure (2); lock the clamp in place at two points using the special pliers (3).

16F

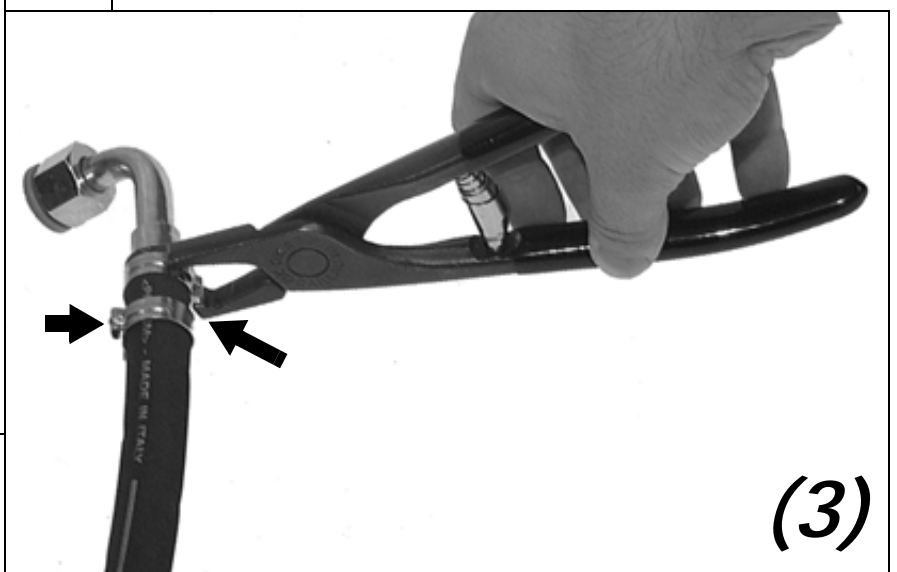

(3)

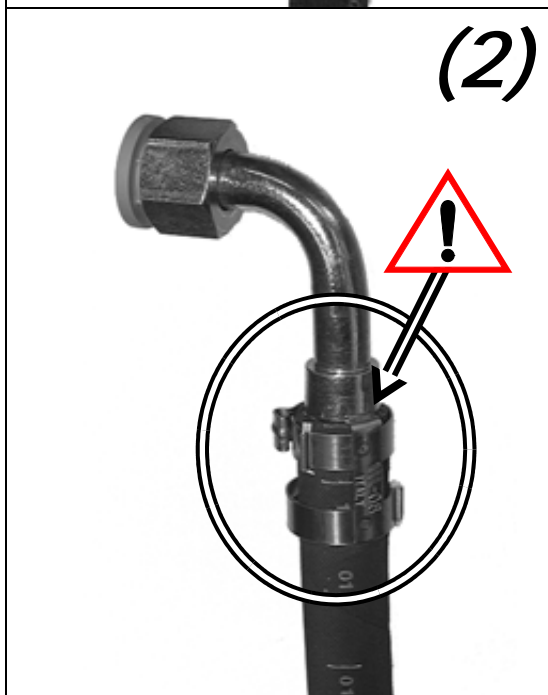

(2)

(D) BLOCKIERUNGSVERFAHREN ALLER KÜHLMITTELSCHLÄUCHE AN DEN VERBINDUNGSTÜCKEN

(1) O.R. Ring ölen: Verbindungsstück an Schlauch ankuppeln und die Schelle mit dem Anschlag des Betätigungshebels in gezeigter Position anbringen (2): mit entsprechender Zange die Schelle in den beiden Punkten festziehen (3).

(E) PROCEDIMIENTO PARA LA FIJACIÓN DE TODOS LOS TUBOS A LOS RACORES

(1) Lubricar O.R., insertar el racor en el tubo colocando la banda con la lengüeta de golpe en la posición de figura (2); bloquear la banda en los dos puntos con pinza apropiada (3).

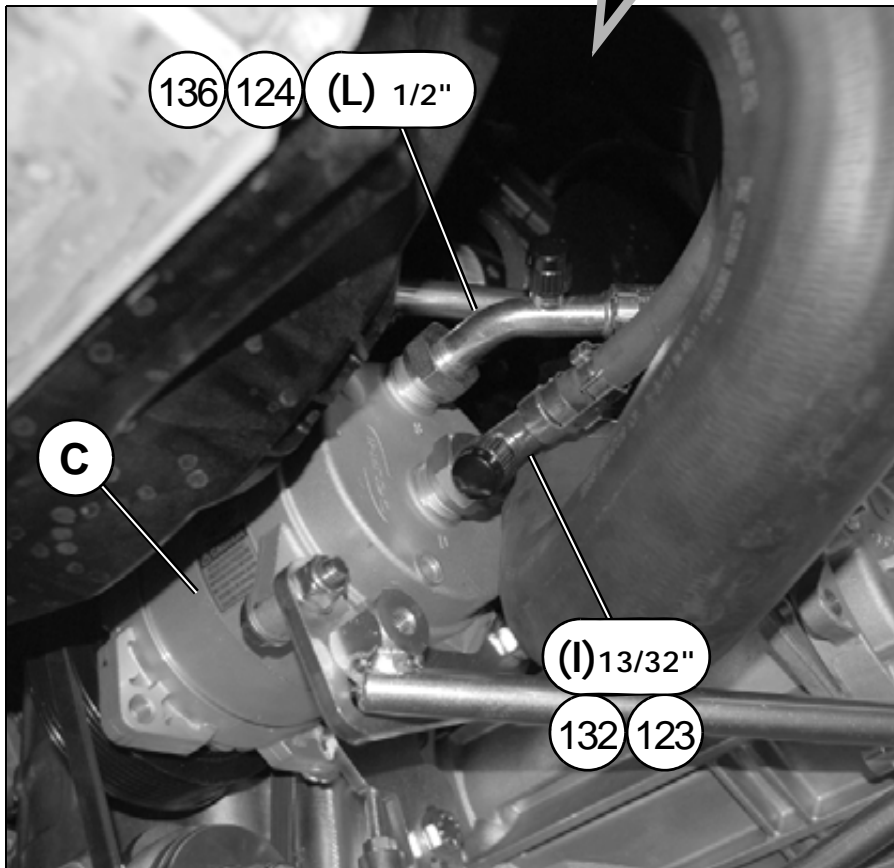
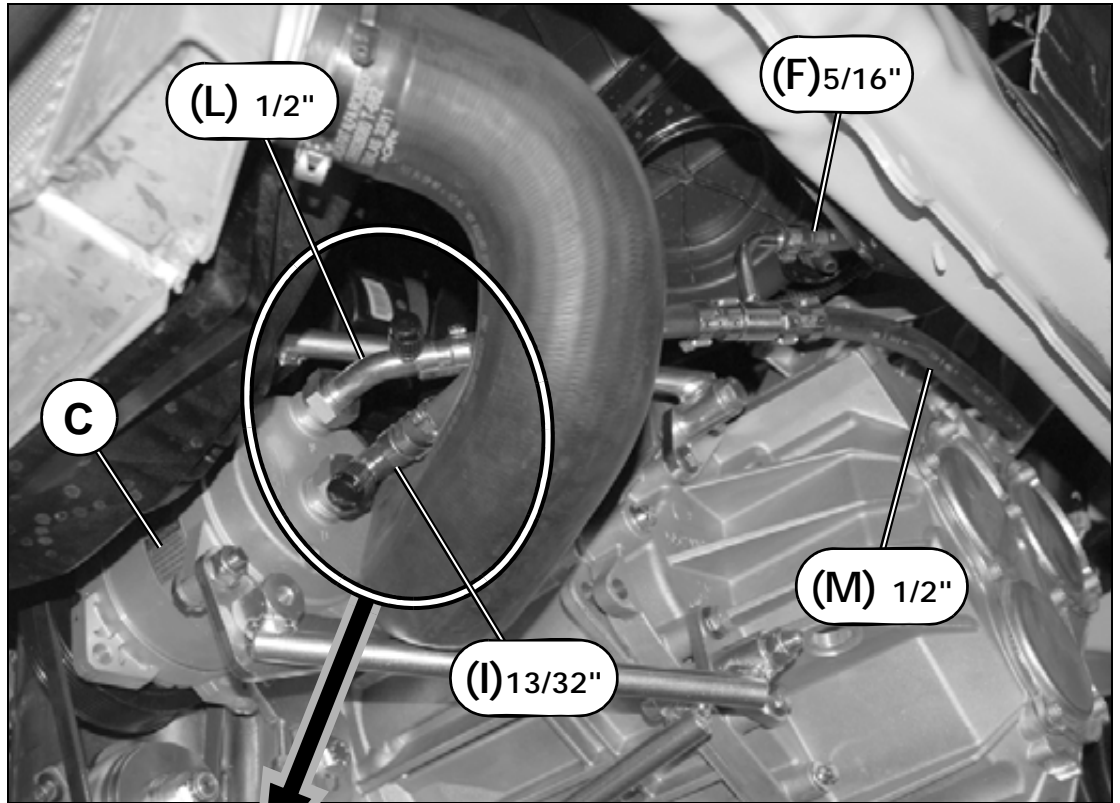

17F

+ OPTIONAL KIT

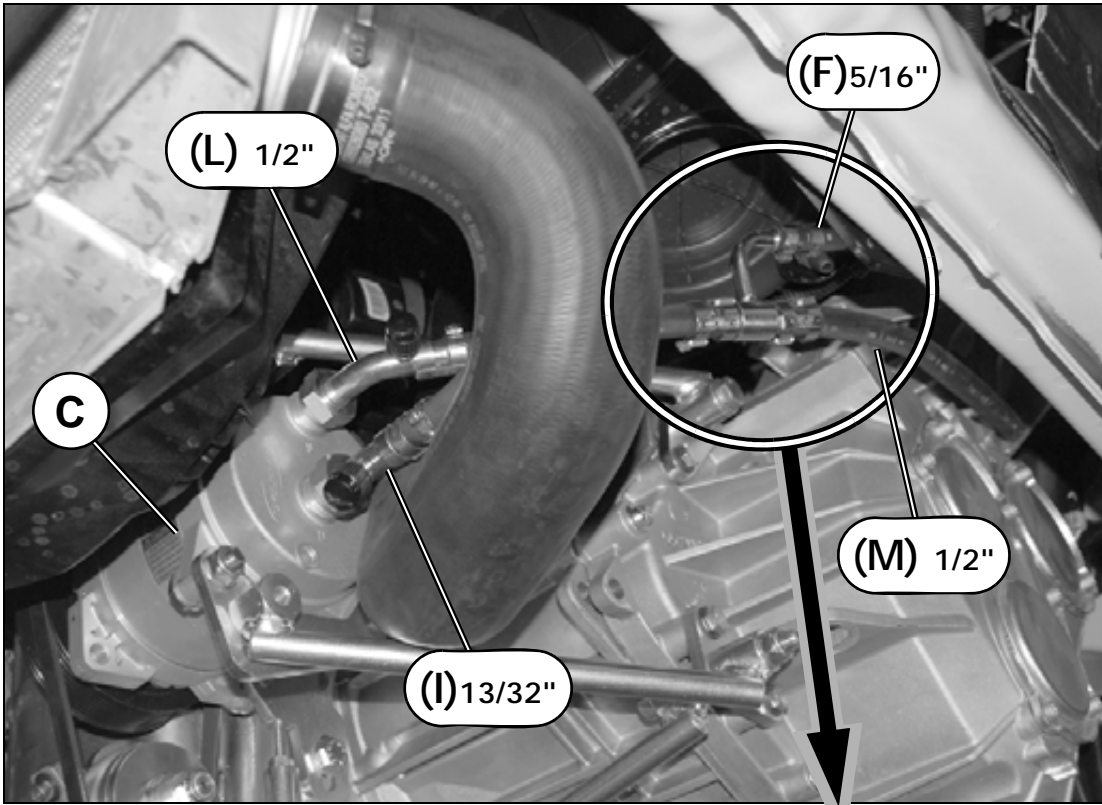

18F

+ OPTIONAL KIT

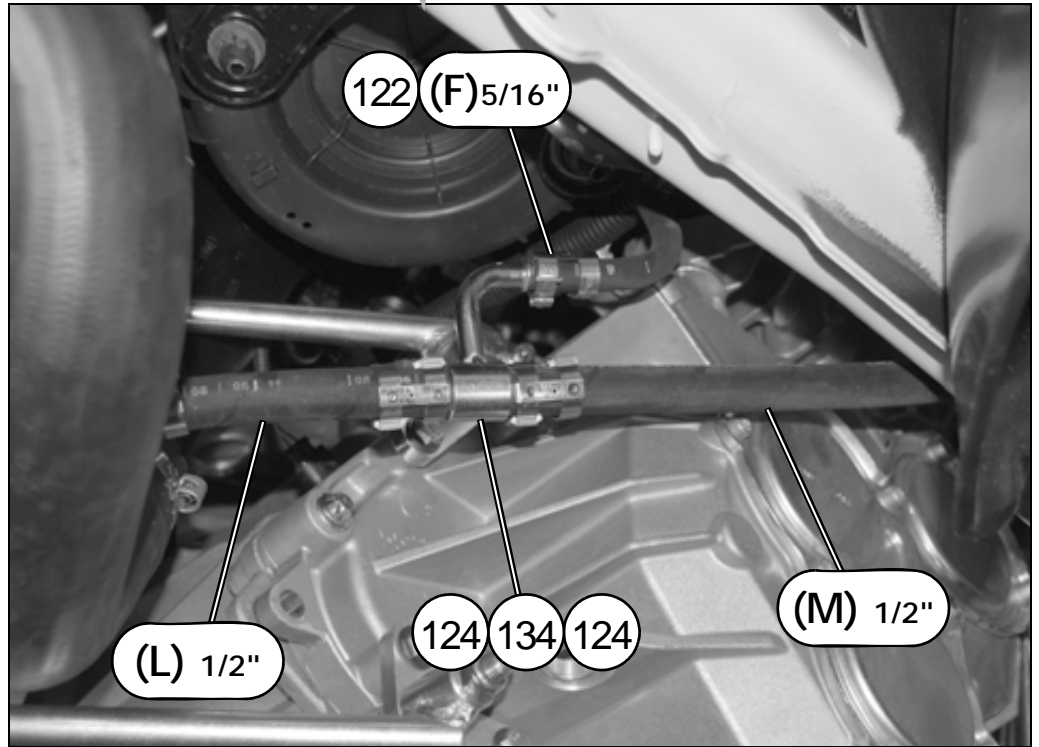

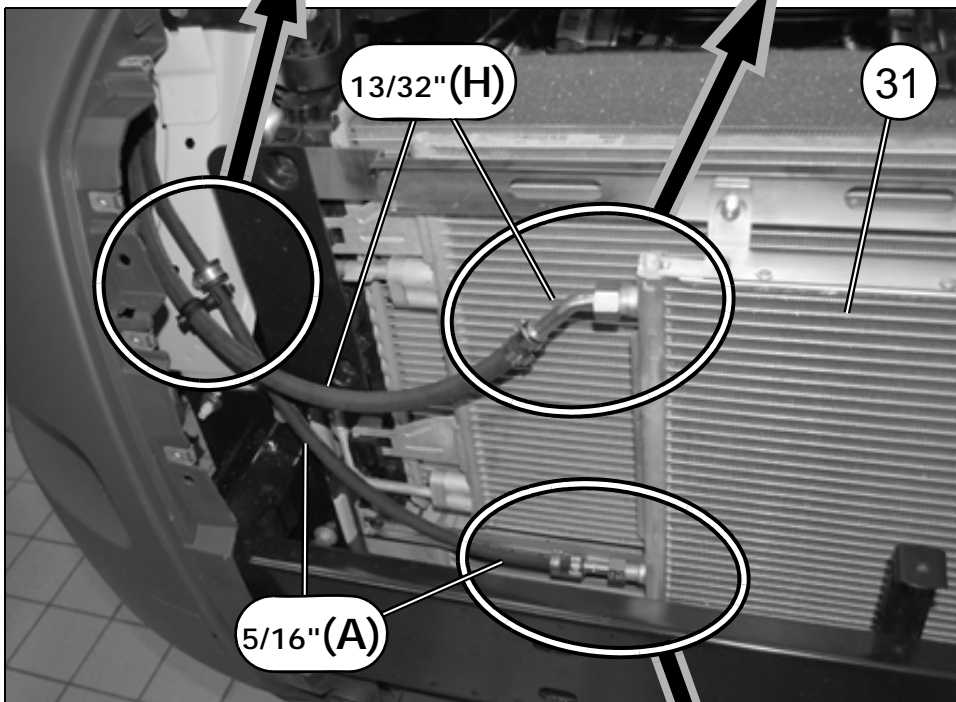
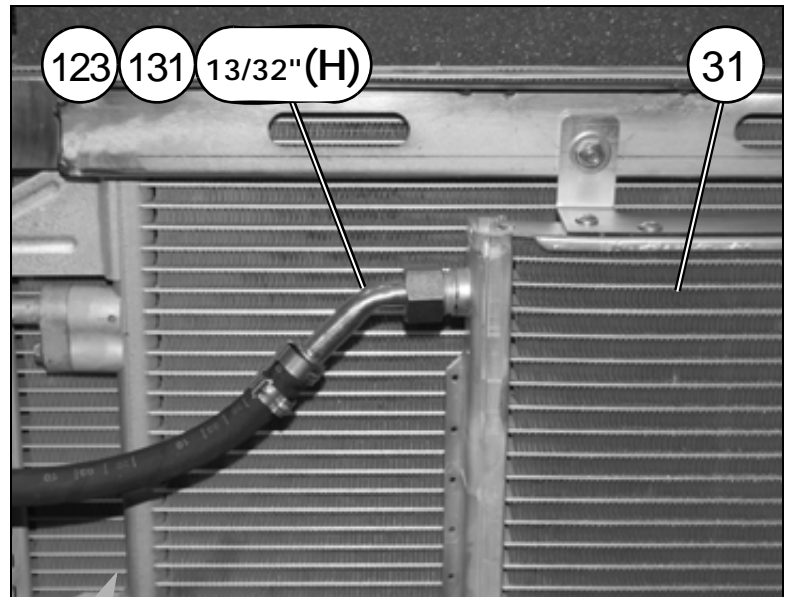
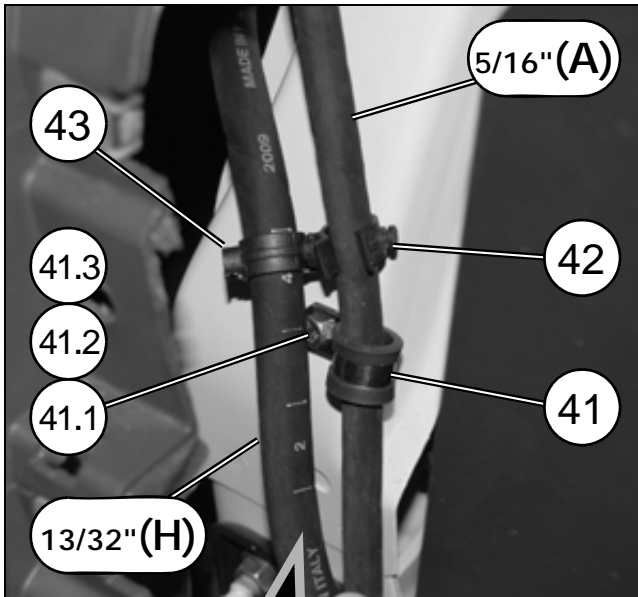

19F

+ OPTIONAL KIT

ELEMENTI DI FISSAGGIO / PIÈCES DE FIXATION FIXING PARTS / BEFESTIGUNGSELEMENTE ELEMENTOS DE FIJACION		
Pos.	Tipologia / Typologie Typology / Tipologie Tipologia	Descrizione / Description Description / Beschreibung Descripción
41.1		M6 x 16
41.2		φ 6
41.3		M6
42		Fermatubo φ 18
43		Fermatubo φ 24

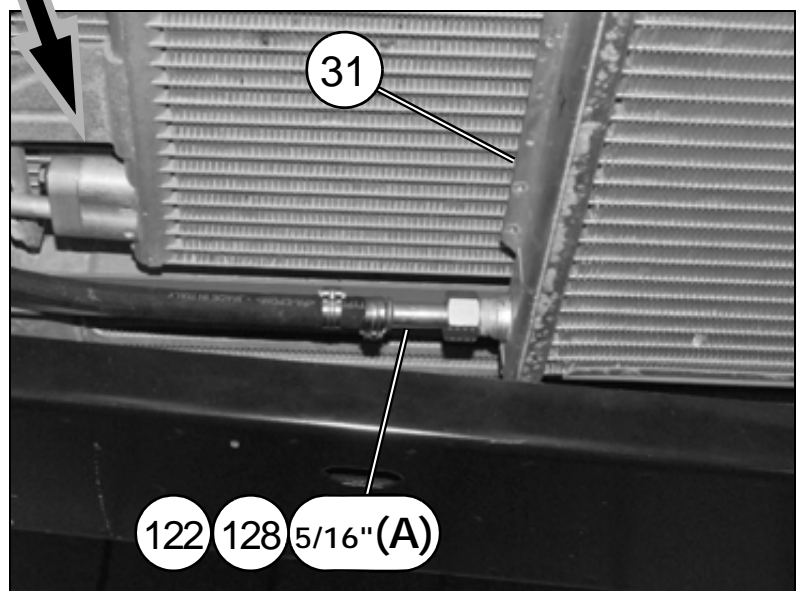

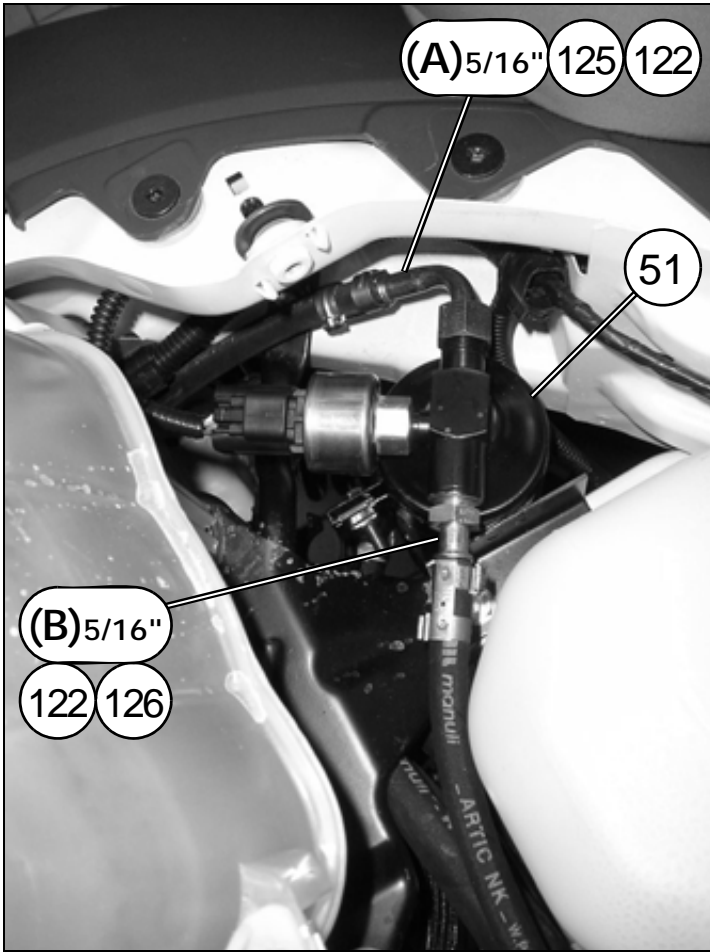

20F

+ OPTIONAL KIT

21F

+ OPTIONAL KIT

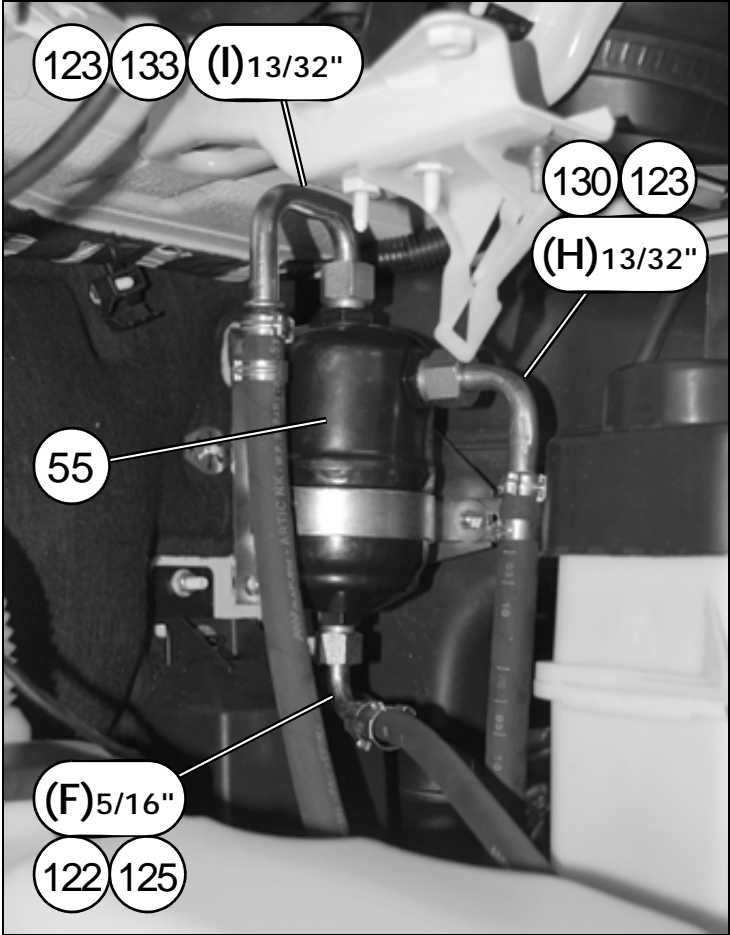

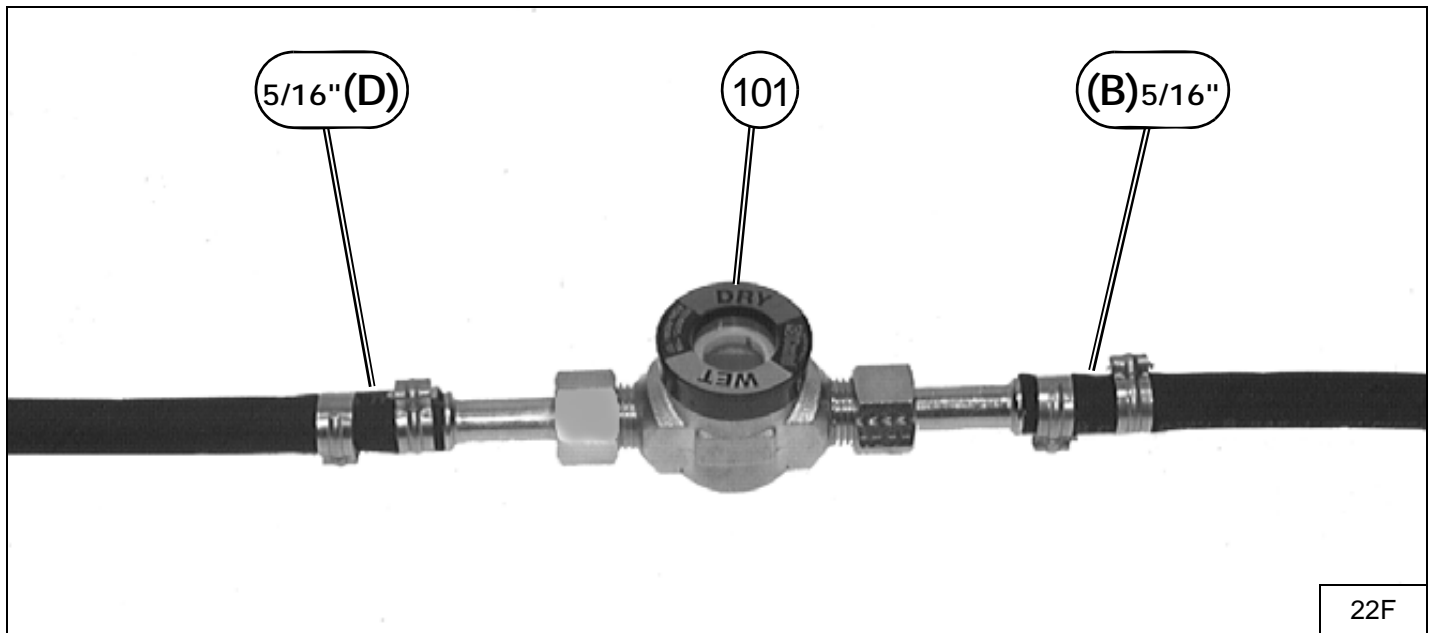

**(I)**

Inserire l'indicatore di passaggio liquido e umidità "101" lungo il tubo gas 5/16", diretto verso il gruppo refrigerante DIAVIA FRIGO "61", come indicato in figura 15F, alloggiandolo cura dell'installatore, in una posizione adeguata per il controllo dello stato del refrigerante attraverso il vetro spia predisposto.

**(F)**

Insérer l'indicateur de passage de liquide et d'humidité "101" le long du tuyau de gaz 5/16", dirigé vers le groupe réfrigérant DIAVIA FRIGO "61", comme indiqué sur la figure 15F, l'installateur aura soin de le placer, dans une position adéquate pour le contrôle de l'état du réfrigérant à travers le verre témoin existant.

**(GB)**

Insert the fluid flow and humidity indicator "101" along the 5/16" gas hose running to the DIAVIA FRIGO refrigeration unit "61" as indicated in figure 15F. The installer must set it in a position so that it is possible to check the condition of the refrigerant passing through the arranged sight glass.

**(D)**

Den Flüssigkeits- und Feuchtigkeitsanzeiger "101" entlang des zur Kühlgruppe DIAVIA FRIGO "61" führenden 5/16" Kältemittelschlauchs, wie in Abbildung 15F durch einen Installateur sorgfältig einführen und in einer angemessenen Position unterbringen, um den Stand des Kühlmittels durch das vorhandene Kontrollfenster aus Glas ablesen zu können.

**(E)**

Introducir el indicador de paso de líquido y humedad "101" a lo largo del tubo gas 5/16", en dirección al grupo refrigerante DIAVIA FRIGO "61", como se indica en la figura 15F, el instalador lo ha de colocar en una posición adecuada para controlar el estado del refrigerante a través del cristal espía predisposto.

**DAVIA FRIGO "MY 2007"**

**Soluzione abbinamento impianti elettrici - solution accouplement faisceaux electriques - wiring systems mismatch solution  
Verbindungsversion der Elektrischenanlagen - Solución acoplamiento instalaciones electricas**

14/11/06

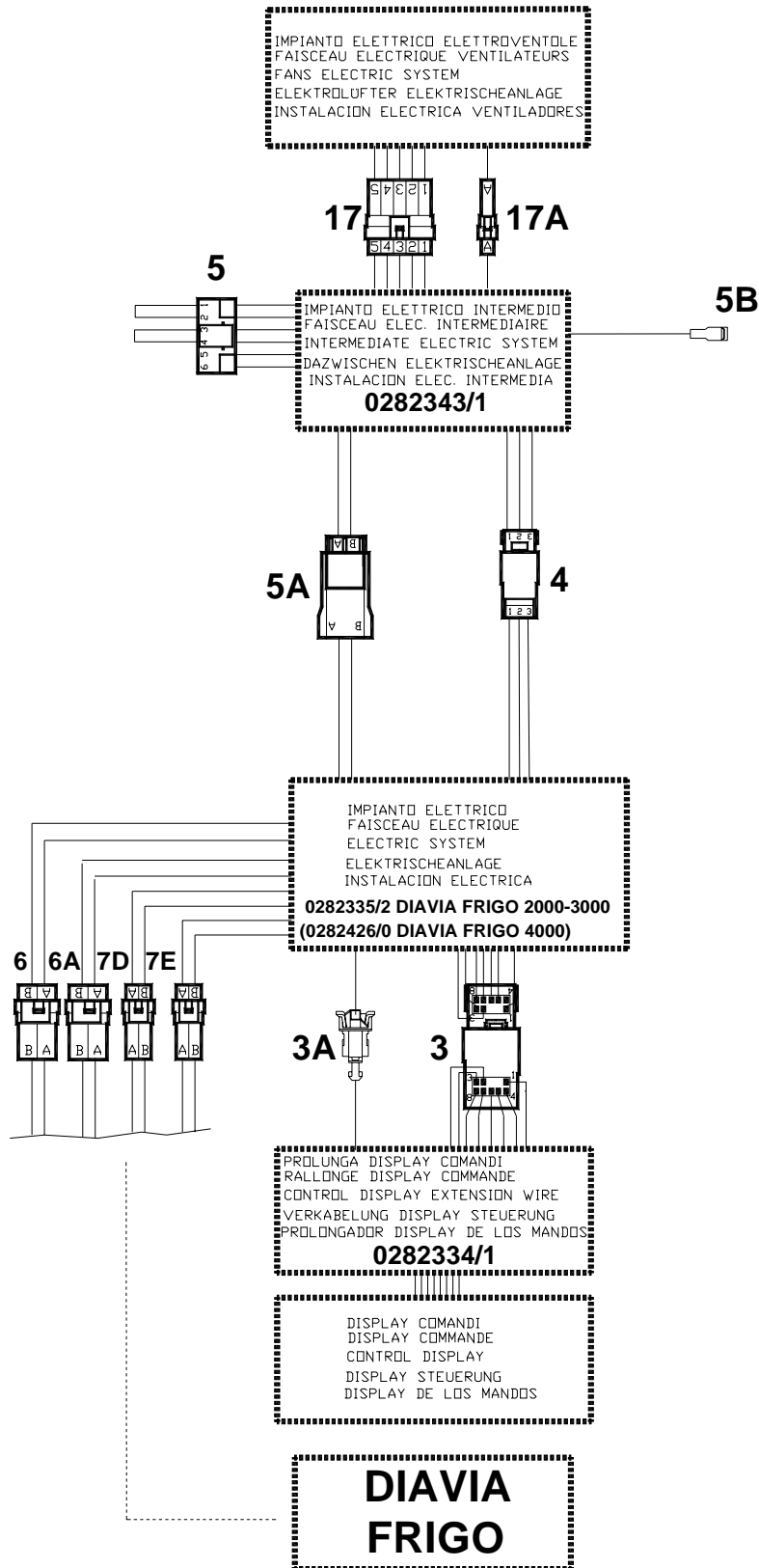



**SCHEMA IMPIANTO ELETTRICO / SCHEMA DE L'INSTALLATION ELECTRIQUE / WIRING DIAGRAM  
SCHEMA DER ELEKTRISCHEN ANLAGE / ESQUEMA INSTALACION ELECTRICA  
DIAVIA FRIGO " MY2007 "**

20-11-06

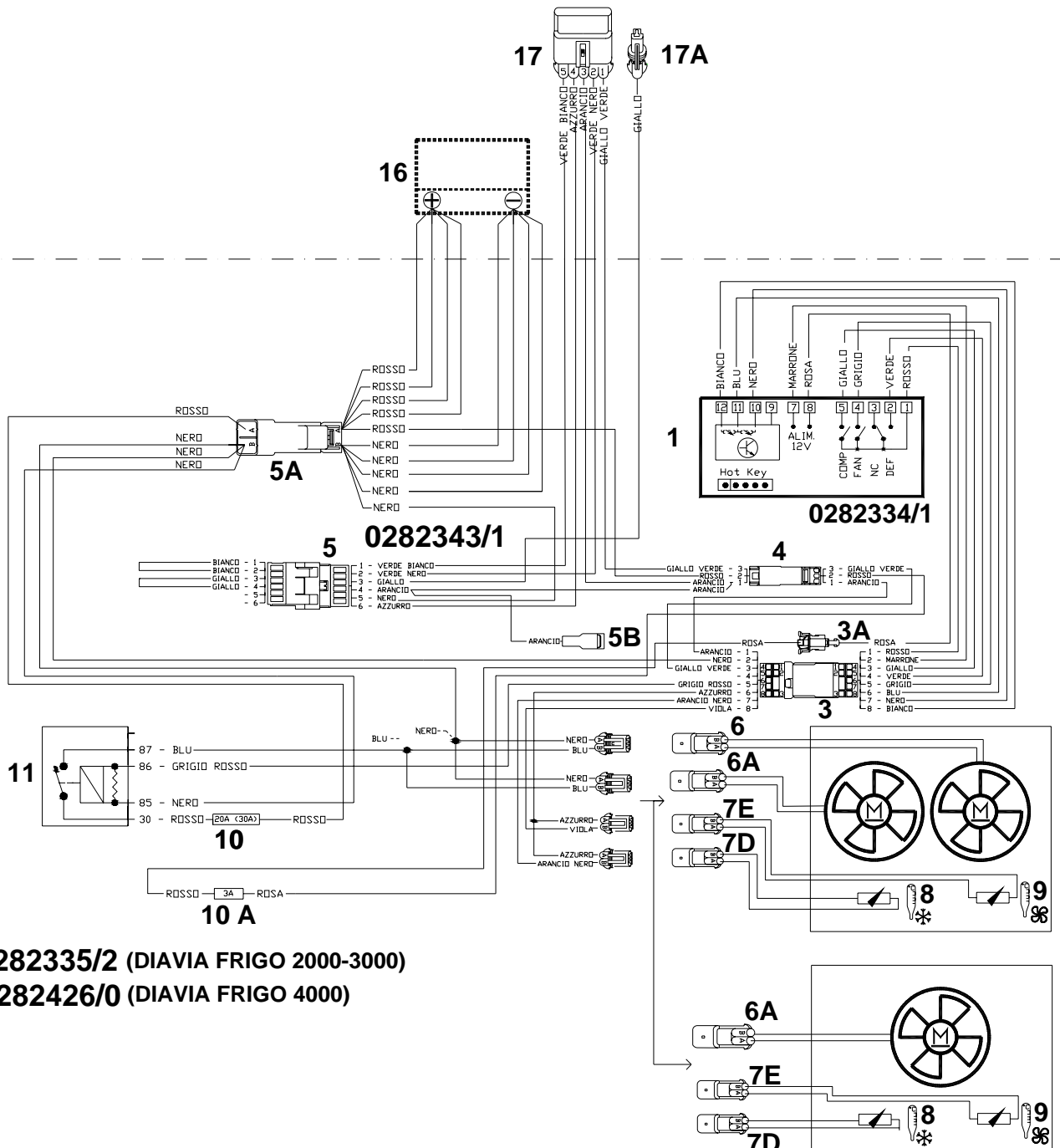

**0282335/2 (DIAVIA FRIGO 2000-3000)**  
**0282426/0 (DIAVIA FRIGO 4000)**

SEM019 - DIAVIA FRIGO MY2007 - 56 - DIXELL - MI-EB

**SCHEMA IMPIANTO ELETTRICO / SCHEMA DE L'INSTALLATION ELECTRIQUE / WIRING DIAGRAM  
SCHEMA DER ELEKTRISCHEN ANLAGE / ESQUEMA INSTALACION ELECTRICA  
FIAT DUCATO 2.0 MJ (SERIE X250) - DIAVIA FRIGO**

**0282458/0  
0282469/0**

**47**

	E/V <sub>34</sub>	E/V <sub>35</sub>
A/C on		
P>15bar		●
P>20bar	●	●

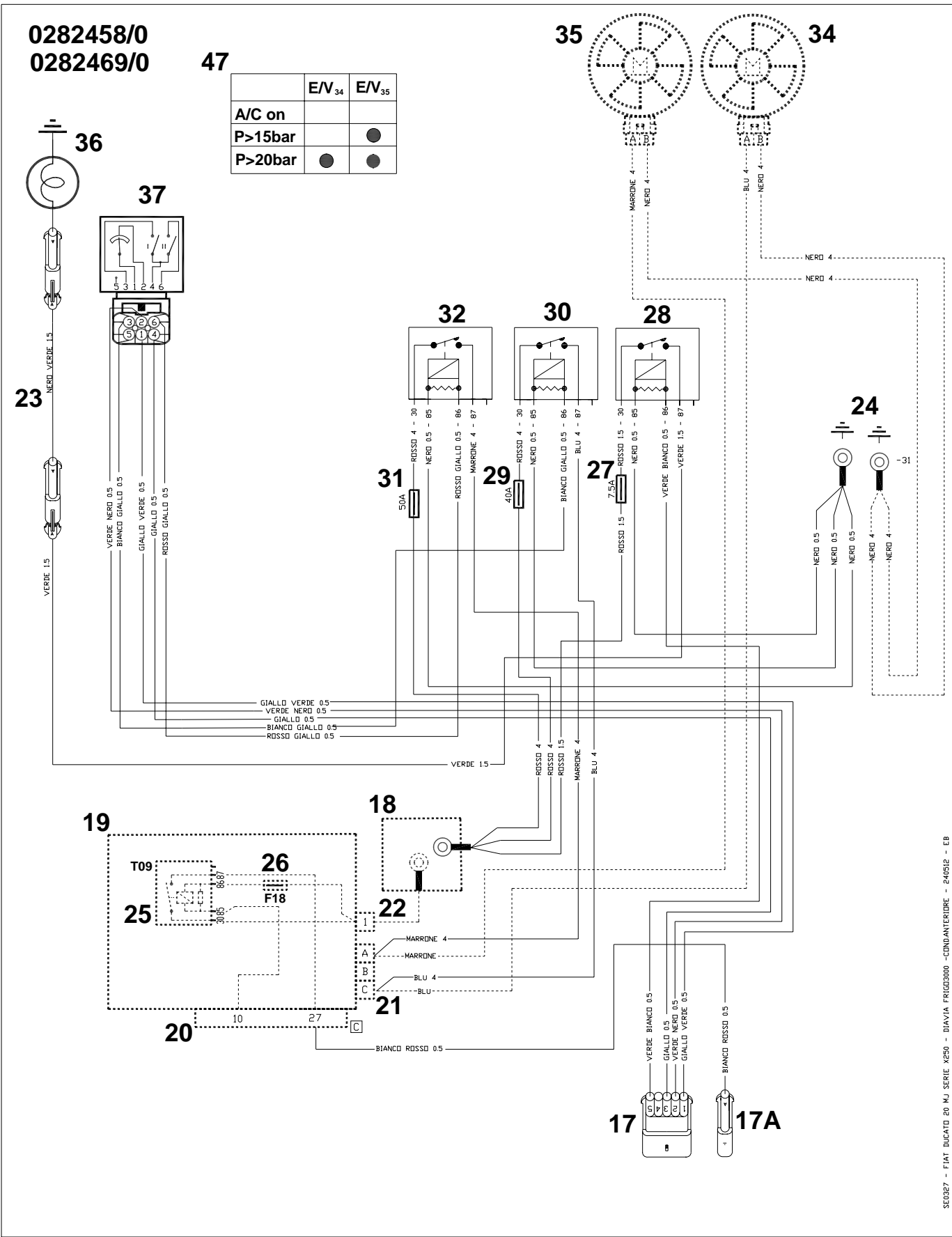

N.	Descrizione / Description / Description Beschreibung / Descripción	Funzione / Fonction / Function Funktion / Función
1	Centralina Dispositif de contrôle Control unit Gehäuse Centralita	Controllo temperatura Côntrôle de la température Temperature control Temperatur-Kontroll Control temperatura
3	Connettore 8 vie Connecteur à 8 voies 8-way connector 8-weg-Steckverbinder Conector 8 vías	Collegamento con impianto evaporatore Connexion au faisceau électrique évaporateur Connection to evaporator electric wiring Anschluß mit Verdampfer Elektroanlage Conexión con instalación evaporador
3A	Connettore 1 via / Connecteur à 1 voie / 1-way connector 1-Weg-Steckverbinder / Conector 1 vía	
4	Connettore 3 vie Connecteur à 3 voies 3-way connector 3-weg-Steckverbinder Conector 3 vías	Collegamento con +CHIAVE (+15) e segnale relay compressore Connexion avec (+15) et signal relais du compresseur Connection with (+15) and compressor relay signal Anschlu( mit (+15) und Kompressor Relay Signal Conexión con (+15) y señal realais compressor
5	Connettore 6 vie / Connecteur à 6 voies / 6-way connector 6-Weg-Steckverbinder / Conector 6 vías	
5A	Connettore 2 vie / Connecteur à 2 voies / 2-way connector 2-Weg-Steckverbinder / Conector 2 vías	
5B	Connettore 1 via Connecteur à 1 voie 1-way connector 1-weg-Steckverbinder Conector 1 vía	Non utilizzare A ne pas utiliser Not to be used Nicht benutzen A no utilizar
6	Connettore 2 vie Connecteur à 2 voies 2-way connector 2-weg-Steckverbinder Conector 2 vías	Collegamento con elettroventola Connexion au électroventilateur Connection to electric fan Anschluß mit Elektrolüfter Conexión con eléctroventilador
6A	Connettore 2 vie Connecteur à 2 voies 2-way connector 2-weg-Steckverbinder Conector 2 vías	Collegamento con elettroventola Connexion au électroventilateur Connection to electric fan Anschluß mit Elektrolüfter Conexión con eléctroventilador
7D	Connettore 2 vie Connecteur à 2 voies 2-way connector 2-weg-Steckverbinder Conector 2 vías	Collegamento con sonda temperatura (DEFROST) Connexion au sonde temperature (DEFROST) Connection to temperatur sensor (DEFROST) Anschluß mit temperature-Fühler (DEFROST) Conexión con sonda temperatura (DEFROST)
7E	Connettore 2 vie Connecteur à 2 voies 2-way connector 2-weg-Steckverbinder Conector 2 vías	Collegamento con sonda temperatura (Cella) Connexion au sonde temperature (Cellule) Connection to temperatur sensor (Cell) Anschluß mit Temperature-Fühler (Zellen) Conexión con sonda temperatura (Celda)
8	Sonda temperatura (DEFROST) / Sonde temperature (DEFROST) Temperatur sensor (DEFROST) / Temperature-Fühler (DEFROST) Sonda temperatura (DEFROST)	
9	Sonda temperatura (Cella) / Sonde temperature (Cellule) Temperatur sensor (Cell) / Temperature-Fühler (Zellen) Sonda temperatura (Celda)	
10	Fusibile 20A (30A) MAXI / Fusible 20A (30A) MAXI 20A (30A) Fuse MAXI / Schmelzsicherung 20A (30A) MAXI Fusible 20A (30A) MAXI	
10A	Fusibile 3A / Fusible 3A / 3A Fuse Schmelzsicherung 3A / Fusible 3A	
11	Relay interruttore 30A Relais de coupure 30A 30A Switch Relay Relais-Schalter 30A Realais interruptor 30A	Comando elettroventola Commande electroventilteur Electric fan control Elektrolüfter Steuerung Comando electroventilador

16	Batteria / Batterie / Battery / Batterie / Bateria	
17	Connettore 5 vie Connecteur à 5 voies 5-way connector 5-weg-Steckverbinder Conector 5 vías	Interfaccia impianto elettrico interno-esterno Interface installation électrique intérieure-extérieure Inner-outer electric system interface Elektrische Anlageninnenfläche innen-au(en) Frente instalación eléctrica interior-exterior
17A	Connettore 1 via Connecteur à 1 voie 1-way connector 1-weg-Steckverbinder Conector 1 vía	Interfaccia impianto elettrico interno-esterno Interface installation électrique intérieure-extérieure Inner-outer electric system interface Elektrische Anlageninnenfläche innen-au(en) Frente instalación eléctrica interior-exterior
18	Terminale ad occhio Borne en boutonnière Ring terminal Ösenstecker Terminal a ojillo	Collegamento con +BATTERIA (+30) Connexion à la BATTERIE (+30) Connection to the BATTERY (+30) Anschluß mit BATTERIE (+30) Conexión con BATERIA (+30)
19	Scatola porta fusibili / Boîte à fusibles / Fuse box Schmelzsicherungskasten / Caja porta-fusibles	
20	Connettore 32 via (NERO) / Connecteur à 32 voie (NOIR) 32-way connector (BLACK) / 32-weg-Steckverbinder (SCHWARZ) Conector 32 vía (NEGRO)	
21	Connettore 3 via / Connecteur à 3 voie / 3-way connector 3-weg-Steckverbinder / Conector 3 vía	
22	Terminale ad occhio Borne en boutonnière Ring terminal Ösenstecker Terminal a ojillo	Punto di derivazione batteria Point de dérivation batterie Battery connector point Batterie-Abzweigungspunkt Punto de conexiones de la batería
23	Prolunga / Rallonge / Extension wire Verlängerungskabel / Prolongador	
24	Punto di massa originale / Point de masse d'origine Original ground point / Original-Massepunkt Punto de masa original	
25	Relay interruttore / Relais de coupure / Switch Relay Relais-Schalter / Realais interruptor	
26	Fusibile 7.5A / Fusible 7.5A / 7.5A Fuse Schmelzsicherung 7.5A / Fusible 7.5A	
27	Fusibile 7.5A / Fusible 7.5A / 7.5A Fuse Schmelzsicherung 7.5A / Fusible 7.5A	
28	Relay interruttore Relais de coupure Switch Relay Relais-Schalter Realais interruptor	Comando giunto elettromagnetico compressore Commande embrayage électromagnétique du compresseur Compressor electromagnetic clutch control Steuerung der elektromagnetischen Kupplung des Kompressors Comando junta electromagnética compresor
29	Fusibile 40A / Fusible 40A / 40A Fuse Schmelzsicherung 40A / Fusible 40A	
30	Relay interruttore Relais de coupure Switch Relay Relais-Schalter Realais interruptor	Comando elettroventola n. 35 Commande électroventilateur n. 35 Controls electric fan no. 35 Steuerung des Elektrolüfter N. 35 Comando electroventilador n. 35
31	Fusibile 50A / Fusible 50A / 50A Fuse Schmelzsicherung 50A / Fusible 50A	
32	Relay interruttore Relais de coupure Switch Relay Relais-Schalter Realais interruptor	Comando elettroventola n. 34 Commande électroventilateur n. 34 Controls electric fan no. 34 Steuerung des Elektrolüfter N. 34 Comando electroventilador n. 34
34	Elettroventole Electroventilateur Fan Elektrolüfter Electroventilador	Raffreddamento condensatore Refroidissement condenseur Condenser cooling Kondensator Kühlung Enfriamiento condensador

35	Elettroventole Electroventilateur Fan Elektrolüfter Electroventilador	Raffreddamento condensatore Refroidissement condenseur Condenser cooling Kondensatorkühlung Enfriamiento condensador
36	Giunto elettromagnetico compressore Embrayage électromagnétique du compresseur Compressor electromagnetic clutch Elektromagnetische Kupplung des Kompressors Junta electromagnética del compresor	
37	Pressostato Pressostat Pressure switch Druckwächter Presostato	Protezione impianto A/C Protection équipement A/C A/C system safety device Klimaanlagen-Überlastungsschutz Protección de la instalación A/C
47	Logica funzionamento elettroventola Logique fonctionnement électroventilateur Electric fan logic Betriebslogik der Elektrolüfter Logica funcionamiento electroventilador	

**(I)**

**N.B.:**

Le parti in tratteggio rappresentano componenti dell'impianto elettrico originale.

**(F)**

**N.B.:**

Les parties hachurées représentent des composants du faisceau électrique d'origine.

**(GB)**

**N.B.:**

The dashed parts represent components of the original electric system.

**(D)**

**N.B.:**

Die gestrichelten Teile stellen Bauteile der ursprünglichen Anlage dar.

**(E)**

**N.B.:**

Les partes discontinuas representan componentes de la instalación eléctrica original.

ITALIANO	FRANCAIS	ENGLISH	DEUTSCH	ESPANOL
Arancio	Orange	Orange	Orange	Naranja
Azzurro	D'azur	Light blue	Hellblau	Azul
Bianco	Blanc	White	Weiss	Blanco
Blu	Bleu	Blue	Blau	Turqui
Giallo	Jaune	Yellow	Gelb	Amarillo
Grigio	Gris	Gray	Grau	Gris
Marrone	Marron	Brown	Braun	Marron
Nero	Noir	Black	Schwarz	Negro
Rosa	Rose	Pink	Rosa	Rosa
Rosso	Rouge	Red	Rot	Rojo
Verde	Vert	Green	Grün	Verde
Viola	Violet	Violet	Violett	Violado

**(I)**  
Webasto Diavia mira ad un costante miglioramento dei propri prodotti. La Casa si riserva il diritto di apportare in qualunque momento e senza preavviso modifiche ai modelli e ai componenti descritti in questa pubblicazione per ragioni di natura tecnica o commerciale. Per ulteriori informazioni rivolgersi al servizio assistenza Webasto Diavia.

**(F)**  
Webasto Diavia vise à une amélioration constante des ces produits. La maison se réserve le droit d'apporter, à tout moment et sans préavis, des modifications aux modèles et aux composants décrits dans cette publication pour des raisons d'ordre technique ou commerciale. Pour d'ultérieures informations s'adresser au service d'assistance Webasto Diavia.

**(GB)**  
Webasto Diavia focuses on constant upgrading of its products. The Manufacturer reserves the right to modify the models and components described in the present publication at any time for technical or commercial reasons and without prior notice. For further information, contact Webasto Diavia technical services.

**(D)**  
Webasto Diavia ist stets bestrebt die eigenen Produkte zu verbessern. Die Herstellerfirma behält sich das Recht vor, aus technischen oder Verkaufsgründen, zu jeder Zeit und ohne vorherige Ankündigung, Abänderungen an den Modellen und den in dieser Veröffentlichung beschriebenen Einbauteile vorzunehmen. Für weitere Informationen bitten wir Sie, sich an unseren Webasto Diavia Kundendienst zu wenden.

**(E)**  
Webasto Diavia aspira a un constante mejoramiento de su producción. La Fábrica se reserva el derecho de aportar en cualquier momento y sin preaviso modificaciones a los modelos y los componentes descritos en esta publicación por razones técnicas o comerciales. Para ultiores informaciones dirigirse al servicio asistencia Webasto Diavia.

VENDITA E SERVIZIO  
VENTE ET SERVICE

VERKAUF UND SERVICE  
SALE AND SERVICE

**WEBASTO THERMO & COMFORT ITALY S.r.l.**

Via Nobili, 2 40062 Molinella C.P. 69 (Bologna) - Italy

Telefono (0039) 051.6906316

Fax (0039) 051.6906287

Email: [diavia.service@webasto.com](mailto:diavia.service@webasto.com)



MOD. SCHFI432

VI / '12  
(2012)

Questa pubblicazione è stata curata da Webasto Diavia  
Ufficio Documentazione AM - Stabilimento Molinella

This publication has been edited by Webasto Diavia  
AM Documentation Office - Factory Molinella