

Liikenneministeriö on Oy Talmu Ab:n, Salosta, hakemuksesta moottoriajoneuvojen varusteiden ja osien hyväksymisehtojen yhdenmukaistamista ja hyväksymisten vastavuoroista tunnustamista koskevan sopimuksen voimaan saattamisesta annetun asetuksen 2 §:n nojalla päättänyt myöntää sopimuksen tarkoittaman ECE-hyväksymisen hakijan valmistamille TALMU 14 1165-400, 14 1165-401, 14 1165-900, 14 1165-901-merkksille, hyväksymisnumerolla 415 varustetuille, oheisesta hyväksymistodistuksesta ja piirustuksista n:ot 4-12095, 4-12244/1-11, 4-12245/1-2, 4-12246/1-2 lähemmin ilmeneville, E-säännön n:o 4 mukaisille tunnuskilven valaisimille.

Hyväksymismerkinnällä varustettujen valaisimien tulee vastata niitä valaisimia, joiden testaukseen tämä hyväksyminen perustuu. Hyväksyminen voidaan peruuttaa, jos ilmenee, että hyväksymismerkinnällä varustetut valaisimet eivät täytä E-säännön n:o 4 vaatimuksia.

Helsingissä 13 päivänä lokakuuta 1989

Tieliikenneosaston teknillisen
toimiston päällikkö,
yli-insinööri

Reino Lampinen

Yli-insinööri

Esko Kärki

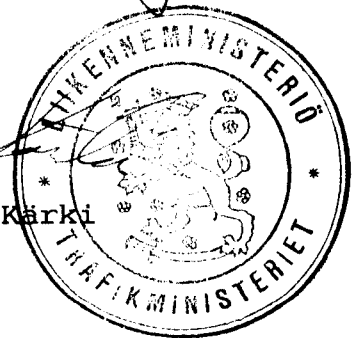

Leimavero 43 mk
Lisäleima 150 mk E
Yhteensä 193 mk

6372/73/89

Oy Talmu Ab
24100 SALO



Date 13.10.1989 Dn:o 6372^{73/} 89

COMMUNICATION CONCERNING
APPROVAL OF A TYPE OF DEVICE
FOR ILLUMINATING REAR
REGISTRATION PLATES

APPROVAL NO. 415

- 1 Device for illuminating - ~~a tall plate~~
- ~~a wide plate~~
- a tall plate and a wide
plate alike
- 2 Trade name or mark Talmu 14 1165-400, 14 1165-401
14 1165-900, 14 1165-901
- 3 Manufacturer's name OY TALMU AB
- Name of his representative (if
applicable)
- 5 Address SF-2400 SALO, FINLAND
- 6 Type, number and power of lamps R10W, one lamp, 10W
- 7 Submitted for approval on
- 8 Test laboratory Valtion teknillinen tutkimus-
keskus, Sähkötekniikan labo-
ratorio (State Technical
Research Centre, Electro-
technical Laboratory)
- 9 Date of laboratory report 27.7.1989
- 10 Number of laboratory report SÄH 91647
- Date of approval
- 12 Date of withdrawal of approval -
- 13 Place Helsinki
- 14 Date 13.10.1989
- 15 Signature 
Reino Lampinen
Head of Division,
Chief Engineer
- 16 The attached drawing No. 4-12095, 4-12244/1-11, 4-12245/1-2, 4-12246/1-
2 shows geometrically the position in which the illuminating device is to
be fitted in relation to the space to be occupied by the registration
plate and the outlines of the adequately illuminated area.

E-HYVAKS/REGU4/kri

Mailing address
Box 235
SF-00131 Helsinki

Street address
Eteläesplanadi 16

Telephone
area code 90
17361
Telex 125472 limin sf
Telefax 1736340

808506683R-22

Area for markings

Bulb R10W 12V/10W

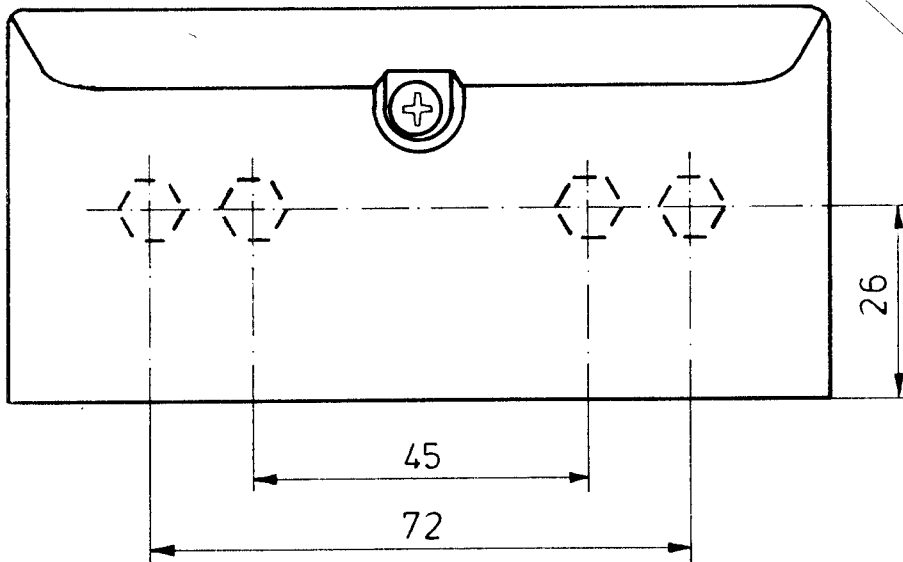
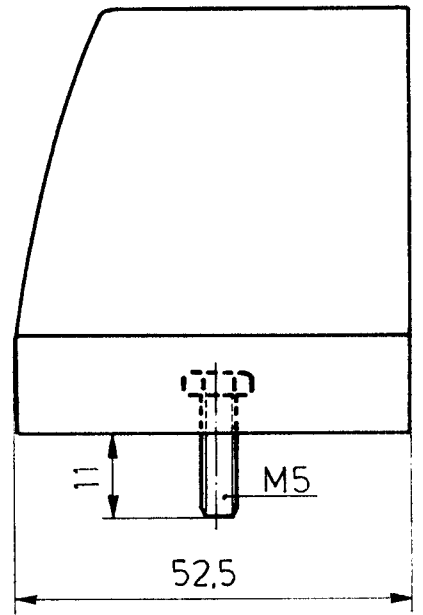
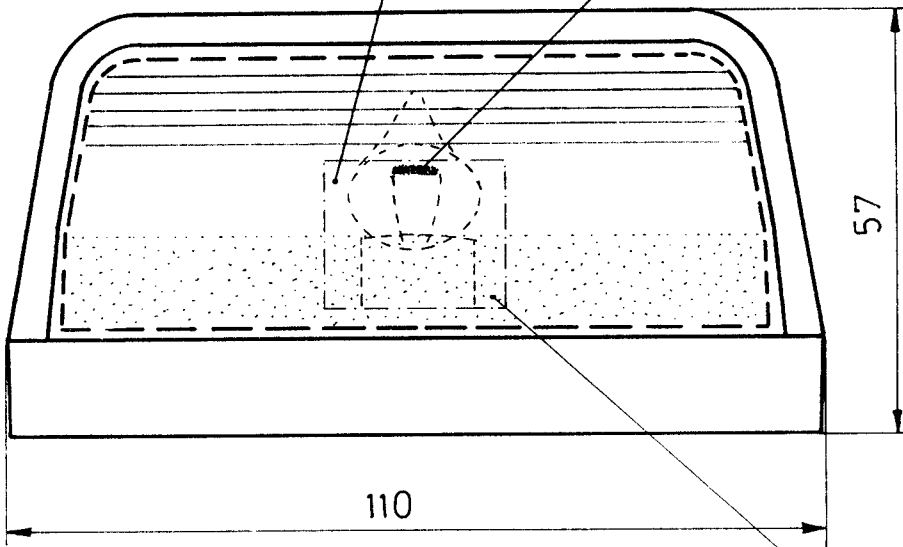

Material: -body, ABS / PC black or beige
 -lens, PMMA clear

Product numbers: 14 1165-400
 14 1165-401
 14 1165-900
 14 1165-901



ANNEXED TO APPROVAL
 NO 415
 13/10 1989

Pos.	Nimitys Description	Piirustus No Drawing No	Muoto/Form Aines/Material	Mitat/Dimensions	Malli No/Model No	kpl Pcs
		Osan lajimerkki/Detail marking				
	Korvaa Replacing		Paino/Weight	Suhde/Scale		TALMU
	Korvattu Replaced by					
	Suunn. Design by	Liitty Belongs	Piirustus No/Drawing No			
	Piirt. Drawn by 05 01 89 KLe					
	Tark. Exam. by	Nimitys Description	Registration plate light "Talmu" 1165		Piirustus No/Drawing No	4-12095
	Hivv. Appr. by					

ANNEXED TO APPROVAL

NO 415

13/10

1989

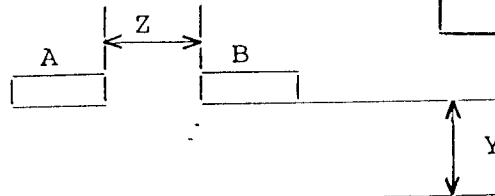

(E17)

A: TALMU 14 1165

B: -"- -"-

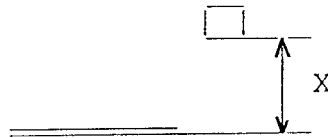

Valcisimen korkeus 0 mm tunnuskilvestä.

Z / mm

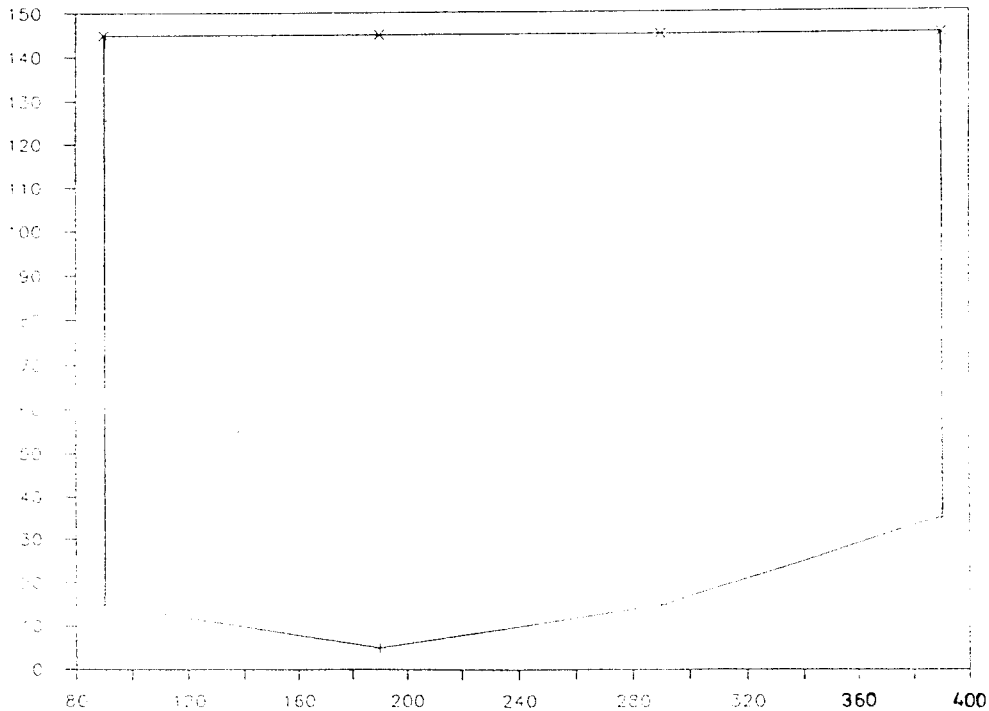

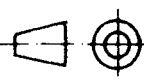
Peri	Nimitys Description	Piirustus No Drawing No	Muoto/Form Aines/Material	Mitat/Dimensions	Malli No/Model No	kp/ Pcs
Korvaa Replacing		Paino/Weight		Suhde/Scale		 TALMU
Korvattu Replaced by						
Suunn. Design by		Liittyy Belongs		Piirustus No/Drawing No		
Piirtäjä Drawn by <i>89 08 15 EH</i>						
Tark. Exam. by		Nimitys Description		Piirustus No/Drawing No		page 1
Hyväksyjä Appr. by		Assembling of reg. plate lamp 1165 TALMU		4 -12244		

ANNEXED TO APPROVAL

NO 415

13/10 1989

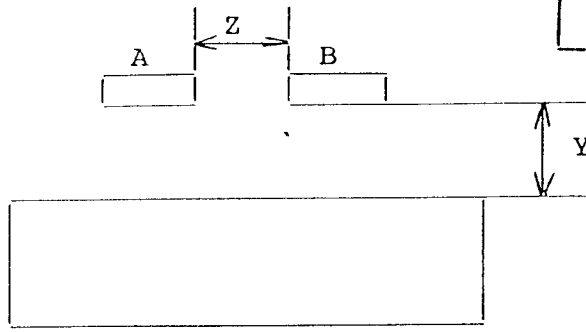

E17

A: TALMU 14 1165

B: -II- -II-

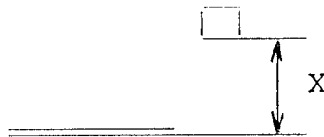

Valoisimen korkeus 10 mm tunnuskiilvestä

Z / mm

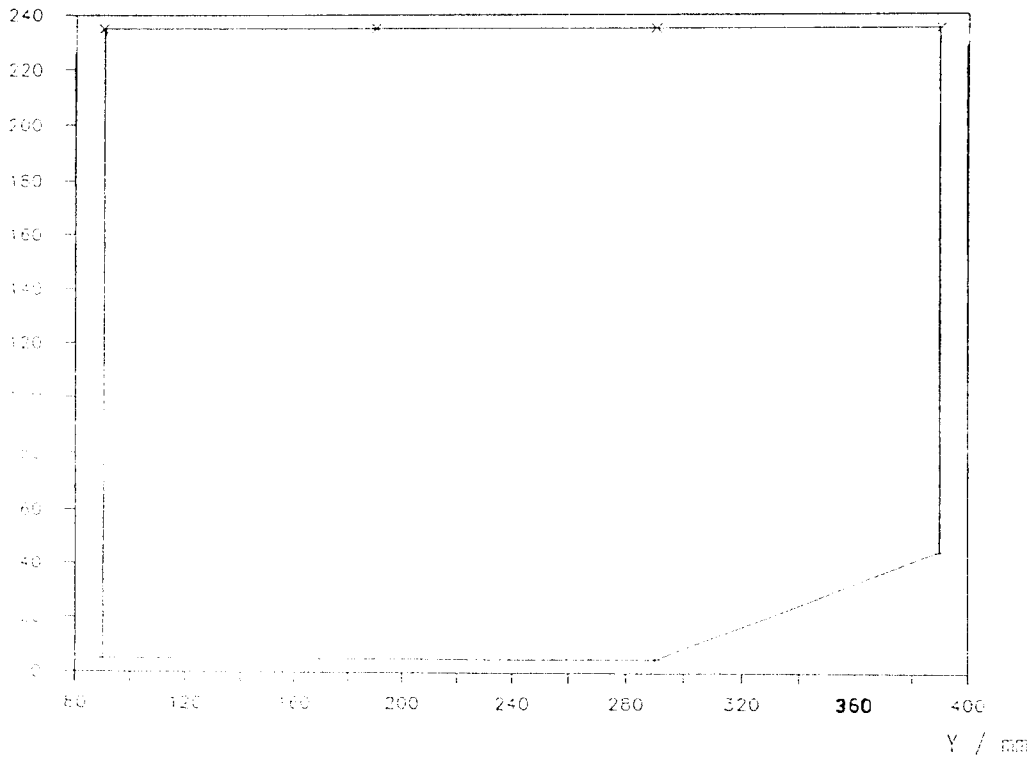

Yks.	Nimitys Descriptor	Piirustus No Drawing No	Muoto/Form Aines/Material	Mitat/Dimensions	Malli No/Model No	kpl Pcs
		Osan lajimerkki/Detail marking				
	Korvaa Replacing		Paino/Weight	Subdi/Scale		
	Korvattu Replaced by					
	Suunn. Design by	Liittyy Belongs	Piirustus No/Drawing No			
	Piirt. Drawn by <i>89 0815 EH</i>					
	Tark. Exam. by	Nimitys Description	Assembling of reg. plate		Piirustus No/Drawing No	
	Hyv. Appr. by	lamp 1165 TALMU		4 - 12244	page 2	

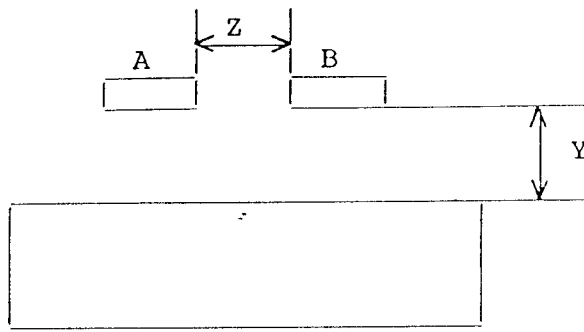

E17

A: TALMU 14 1165
 B: -"- -"-

ANNEXED TO APPROVAL
 NO 415
 13/10 1989

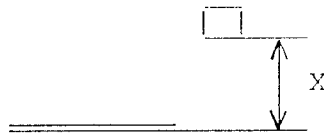

Valaisimen korkeus 20 mm tunnuskilvestö

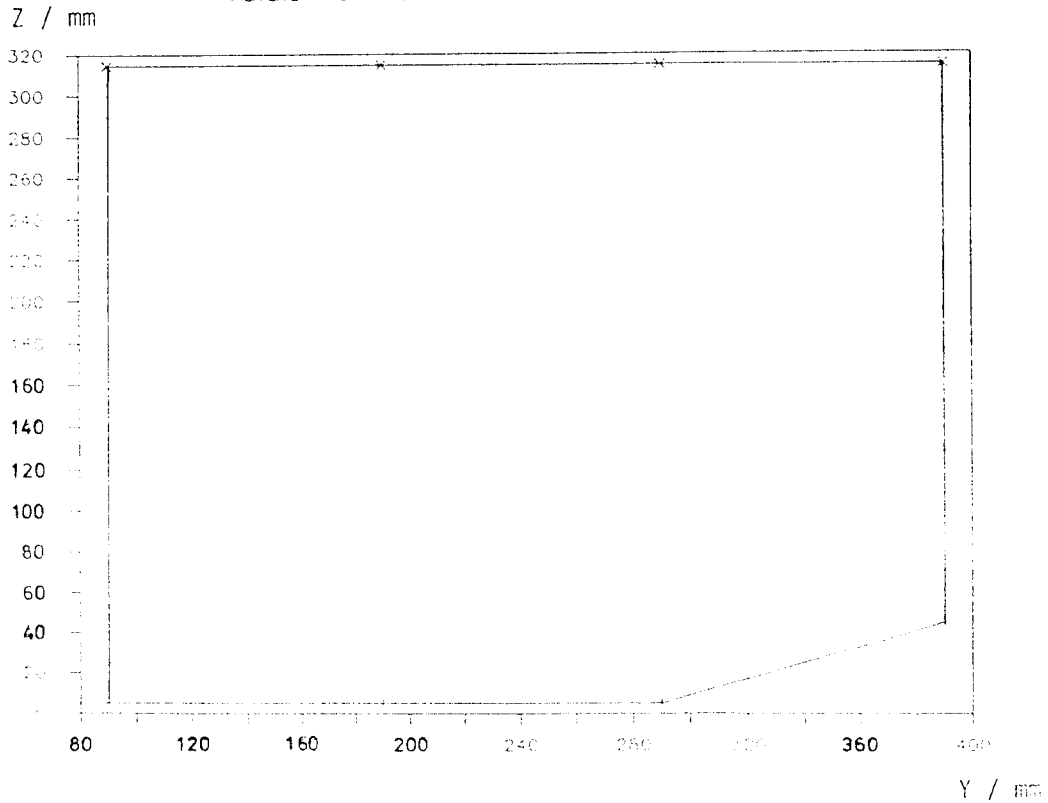

Form	Nimitys Description	Piirustus No Drawing No	Muoto/Form Lines/Material	Mitat/Dimensions	Malli No/Model No	Kp/ Pos
		Osan lajimerkki/Detail marking				
Korvaa Replacing		Paino/Weight	Suhde/Scale			
Korvattu Replaced by						
Suunn. Design by	Liittyy Belongs	Piirustus No/Drawing No				
Post. Drawn by	830815 EH					
Tark. Exam. by	Nimitys Description	Assembling of reg. plate		Piirustus No/Drawing No		
Hyv. Appr. by	lamp 1165 TALMU	4 - 12244		page 3		

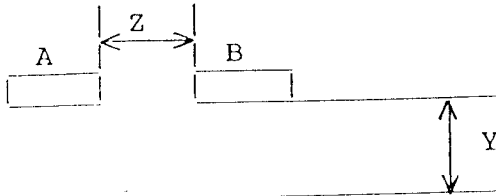

E17

A: TALMU 14 1165
 B: -"- -"-

ANNEXED TO APPROVAL
 NO 415
 13/10 1989

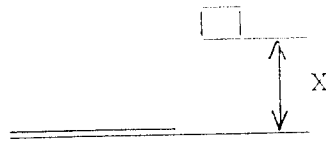

Veldsimen korkeus 30 mm tunnuskilvestö

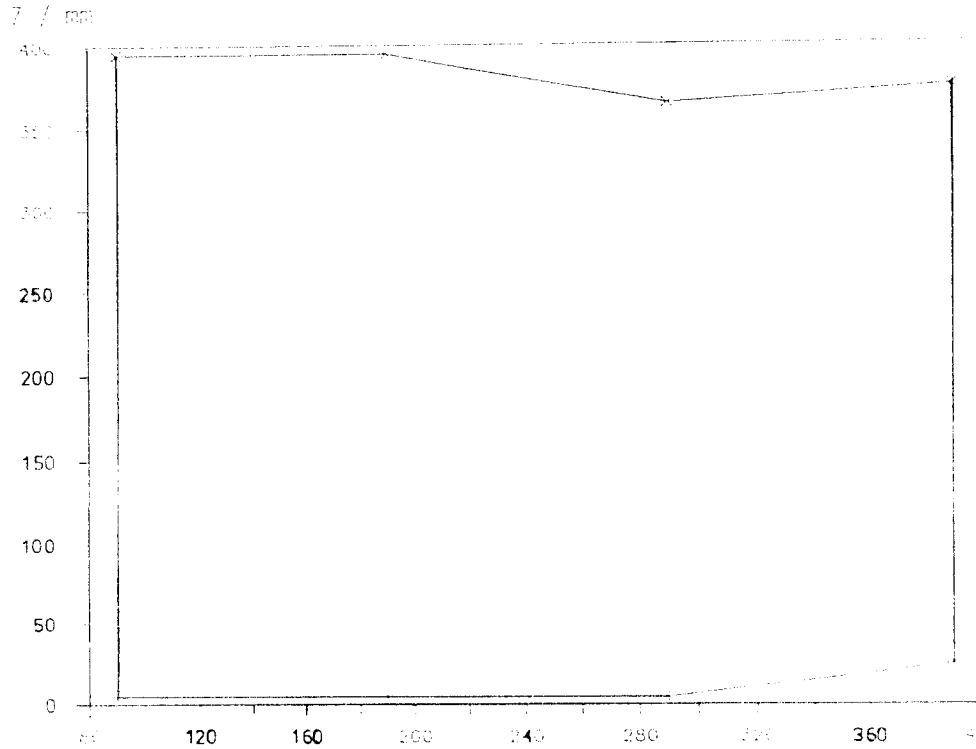

Number	Perustus No / Drawing No	Muoto/Form / Lines/Model	Mitat/Dimensions	Malli No/Model No	Art. / Part
Osan lajimerkki/Detail marking					
Korvaa / Replacing		Paino/Weight	Suhde/Scale		
Korvattu / Replaced by					
Suunn. / Design by	Liittyy / Belongs	Piirustus No/Drawing No			
Part / Drawn by: 890815 EH					
Tark. / Exam. by	Nimitys / Description: Assembling of reg. plate	Piirustus No/Drawing No			
Hyv. / Comp. by	lamp 1165 TALMU	4-12244		page 4	

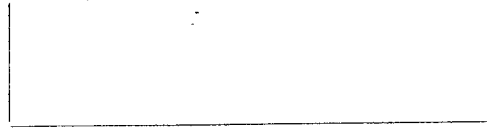
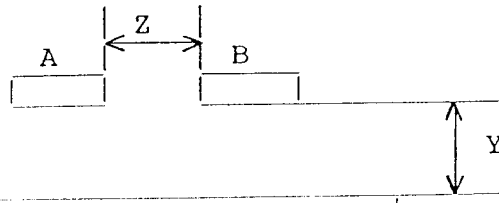

E17

A: TALMU 14 1165
 B: -II- -II-

ANNEXED TO APPROVAL
 NO 415
 13/10 1989

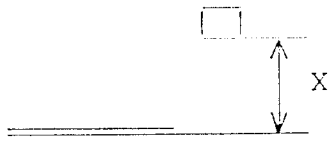

Valcisimen korkeus 40 mm tunnuskilvestö

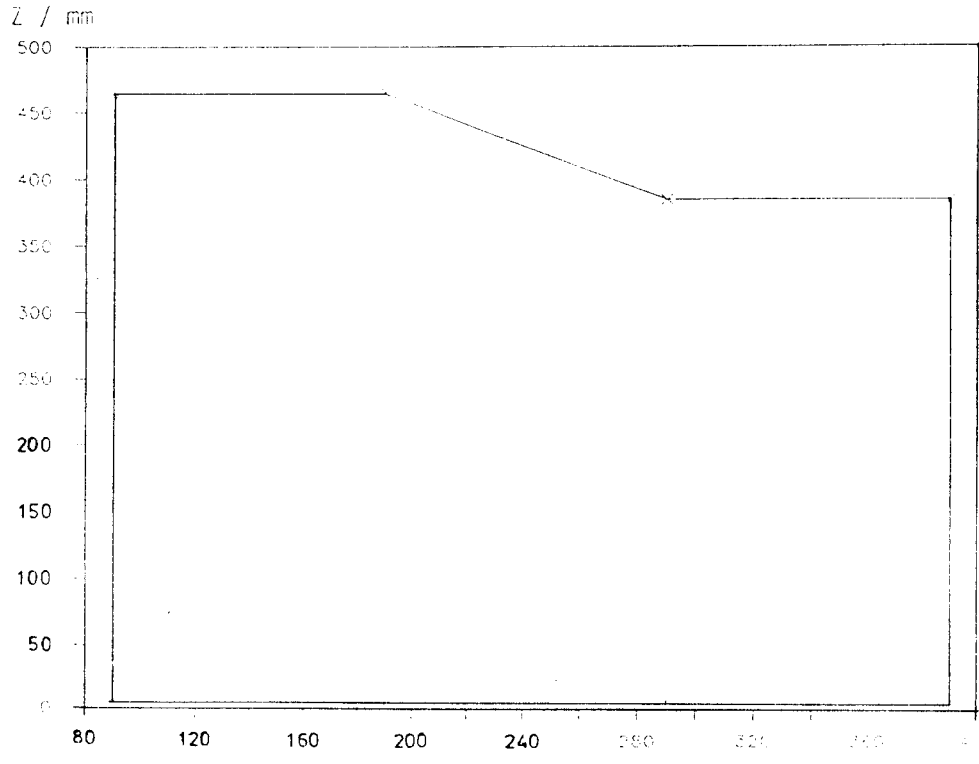

Part	Nimitys Designation	Piirustus No. Drawing No.	Materiaali Material	Mitat/Dimensions	Muut. No/Ampl. No.	Kpl Pcs
Korvaa Replacing		Paino/Weight	Suhde/Scale			
Korvattu Replaced by						
Suunn. Design by	Liittyy Belongs	Piirustus No./Drawing No.				
Part Drawn by: 890815 EH	Nimitys Description: Assembling of reg. plate				Piirustus No./Drawing No.	
Tark. Exam. by	lamp 1165 TALMU				4-12244	page 5
Hv. Appr. by						

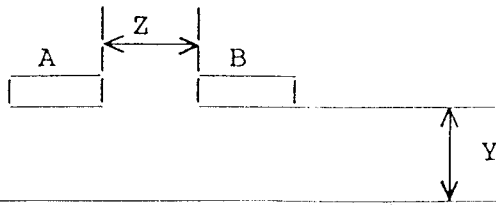

E17

A: TALMU 14 1165
 B: -"- -"-

ANNEXED TO APPROVAL
 NO 415
 13/10 1989

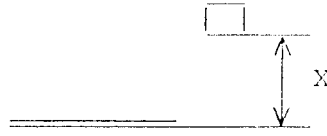

Valoisimen korkeus 50 mm tunnuskilveste

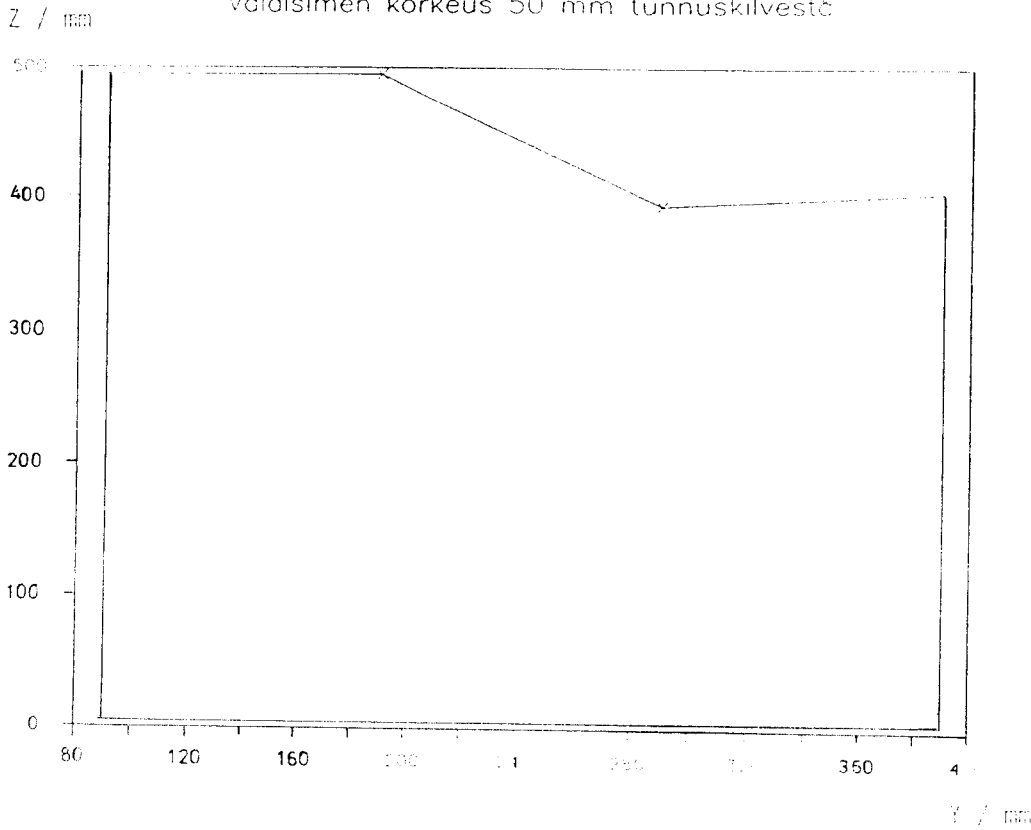

Nimitys / Name		Piirustus No / Drawing No	Muoto/Form / Shape/Form	Mittat/Dimensions	Malli No/Model No	kp / P.
Osan tunnusmerkki/Detail marking		Paino/Weight	Suhde/Scale	TALMU MINEN		
Korvaa / Replacing				Piirustus No/Drawing No		
Korvattu / Replaced by						
Suunn. / Design by	Litty / Belongs		Piirustus No/Drawing No			
Piirt. / Drawn by	890815 EH					
Tark. / Exam. by	Nimitys / Description		Assembling of reg. plate		Piirustus No/Drawing No	
Hyv. / Appr. by	lamp 1165 TALMU		4-12244		page 6	

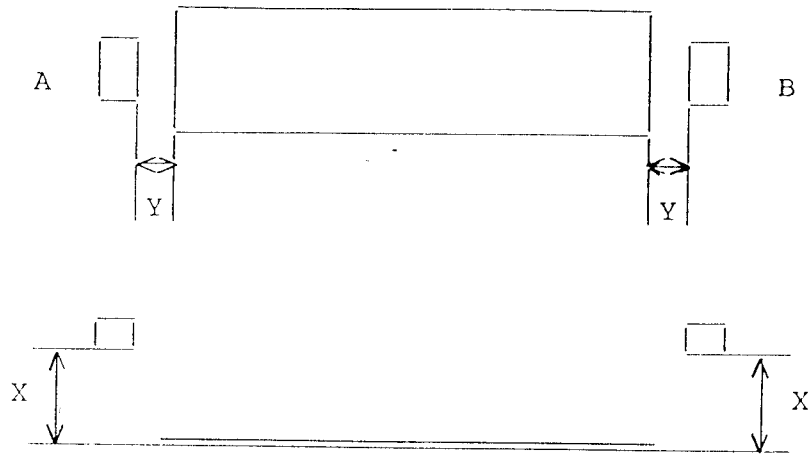

A: TALMU 14 1165
 B: -"- -"-

Y / mm

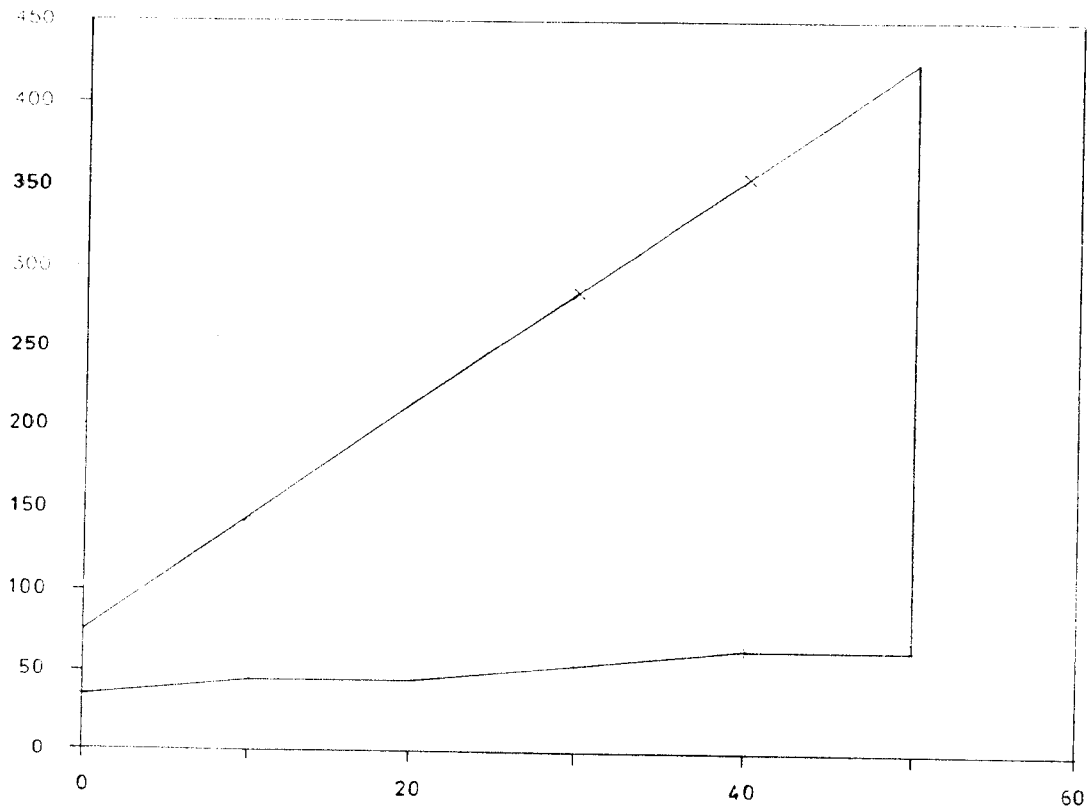

E17

ANNEXED TO APPROVAL
 NO 415
 13/10 1989

X / mm

Nimitys / Description		Projekti No / Drawing No	Muoto/Forma / Shape/Type	Mitat/Dimensions	Malli No/Model No	Nr / No
Korvaa Replacing		Paino/Weight	Suhde/Scale			
Korvattu Replaced by						
Suunn. Design by	Litttyy Belongs			Piirustus No/Drawing No		
Part. Drawn by 890815 EH				1		
Tark. Exam. by	Nimitys Description	Assembling of reg. plate		Piirustus No/Drawing No		
Hyy. Appr. by	lamp 1165 TALMU			4-12244		

A tai B

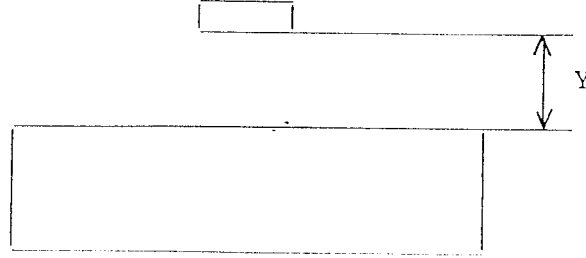

E17

A: TALMU 14 1165
B: -II- -II-

ANNEXED TO APPROVAL
NO 415
13/10 1989

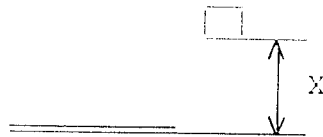

Y / mm

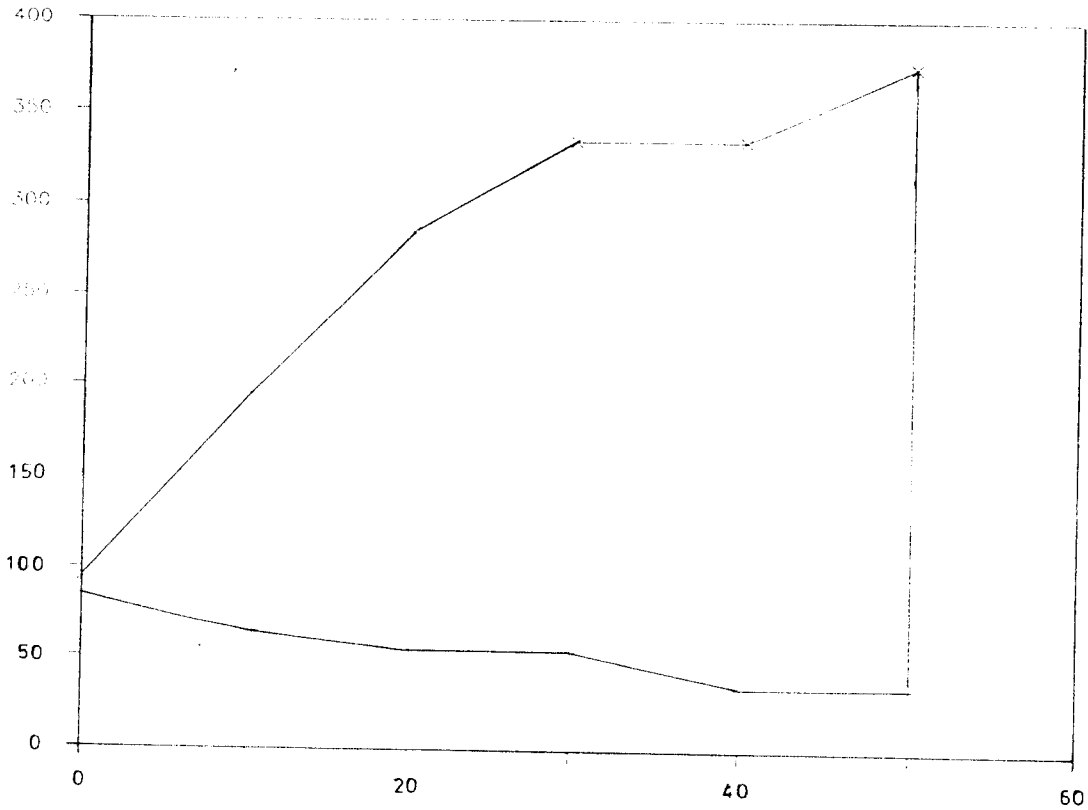

Y / mm

Nimitys Design by	Piirustus No. Drawing No.	Muoto/Form. Shape/Marking	Mitat/Dimensions	Malli No/Model No	kp: Pr.
Osan lajimerkki/Detail marking					
Korvaa Replacing		Paino/Weight	Suhde/Scale	TALMU TALMU	
Korvattu Replaced by					
Suunn. Design by	Litty Belongs	Piirustus No/Drawing No			
Piir. Drawn by	890815 EH	Piirustus No/Drawing No			
Tark. Exam. by	Nimitys Description	Piirustus No/Drawing No			
Hv. Appr. by	Assembling of reg. plate lamp 1165 TALMU	4-12244		page 8	

ANNEXED TO APPROVAL
 NO 415
 13/10 1989

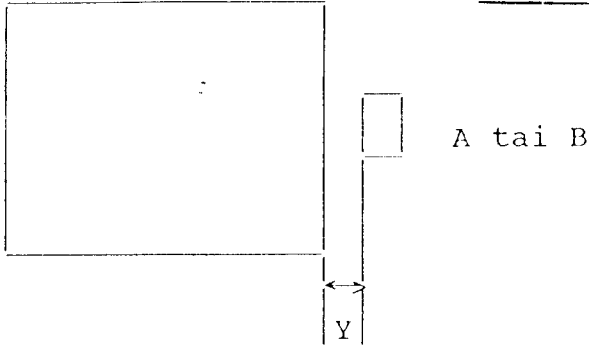

E17

A: TALMU 14 1165
 B: -- --

Y / mm

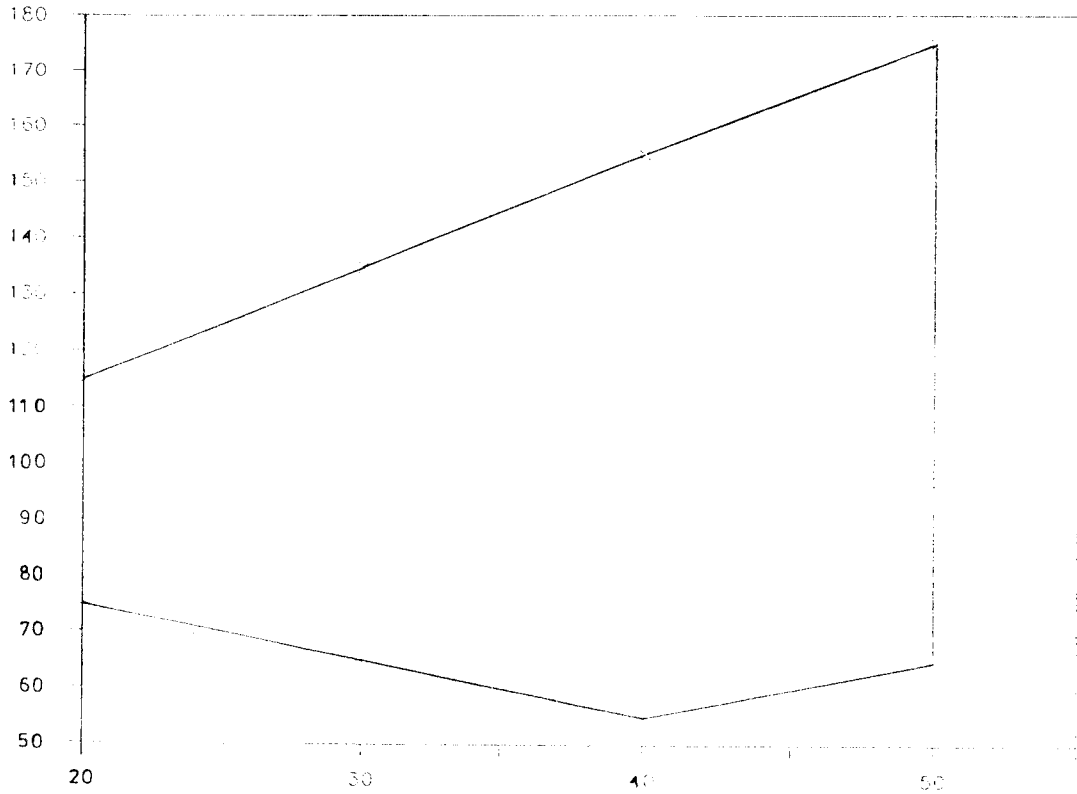

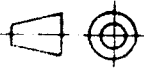
Nimitys / Description		Piirustus No / Drawing No	Muoto/Form / Types/Marking	Mitat/Dimensions	Malli No/Model No	kpl / pcs
Korvaa / Replacing		Paino/Weight		Suhde/Scale		 TALMU
Korvattu / Replaced by						
Suunn. / Design by		Lisäy / Belongs		Piirustus No/Drawing No		
Piirtäjä / Drawn by: 890815 EH						
Tark. / Exam. by		Nimitys / Description: Assembling of reg. plate		Piirustus No/Drawing No: 4-12244		
Hyv. / Appr. by		lamp 1165 TALMU		page 9		

A tai B

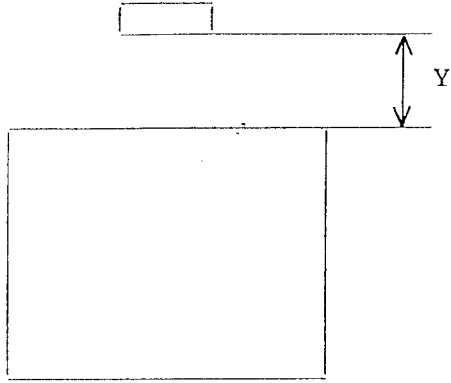

ANNEXED TO APPROVAL
NO 415
13/10 1989

A: TALMU 14 1165
B: -II- -II-

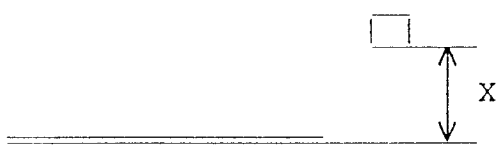

Y / mm

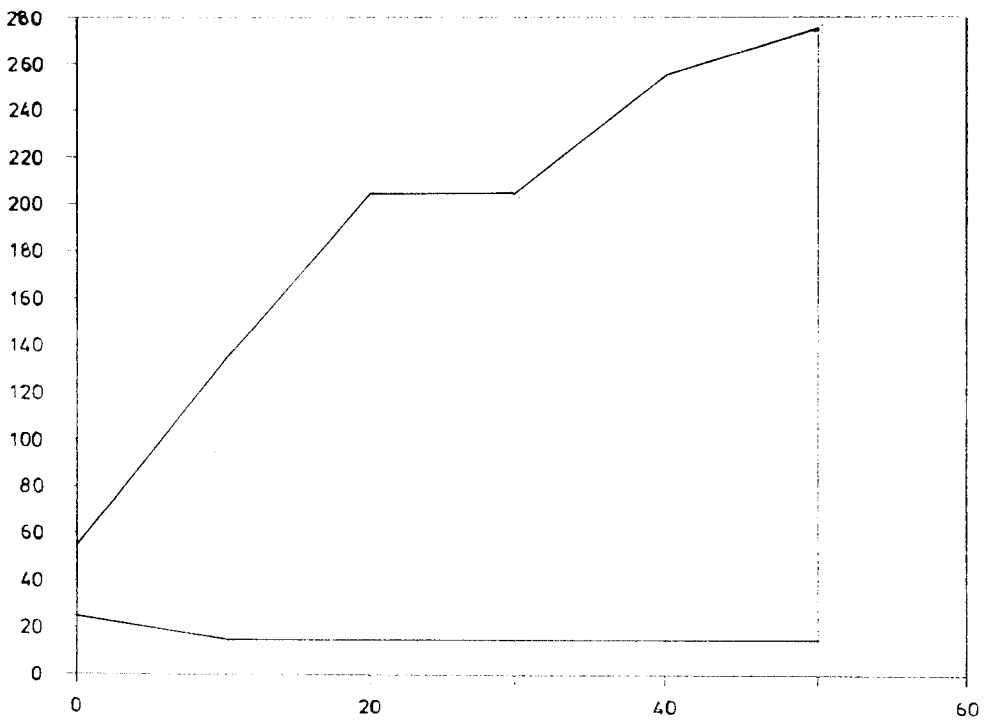

A / mm

Nimitys Task/Assignment	Piirustus No Drawing No	Muoto/Form Lines/Material	Mittat/Dimensions	Malli No/Model No	Yks. Unit
Usan rajamerkki Detail marking					
Korvaa Replacing		Paino/Weight	Suhde/Scale		
Korvattu Replaced by					
Suunn. Design by	Liittyy Belongs	Piirustus No/Drawing No			
Piir. Drawn by 89 08 15 EH					
Tark. Exam by	Nimitys Description	Piirustus No/Drawing No			
Hyv. Appr. by	Assembling of reg. plate lamp 1165 TALMU	4-12244			

A: TALMU 14 1165
 B: -II- -II-

ANNEXED TO APPROVAL
 NO 415
 13/10 1989

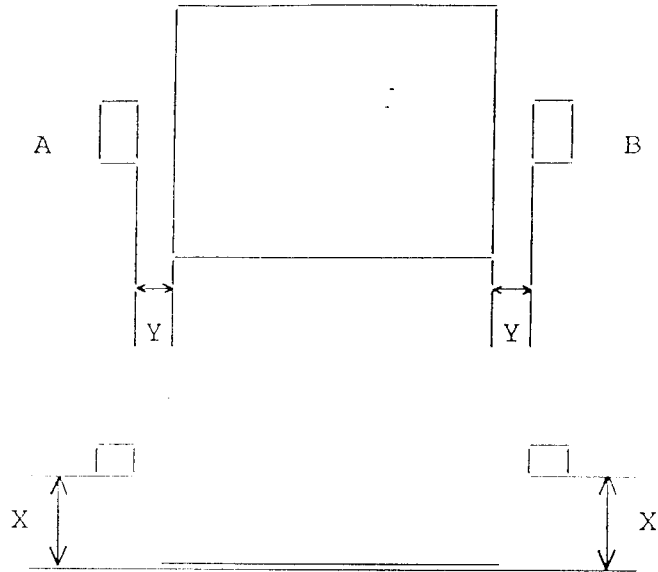

Y / mm

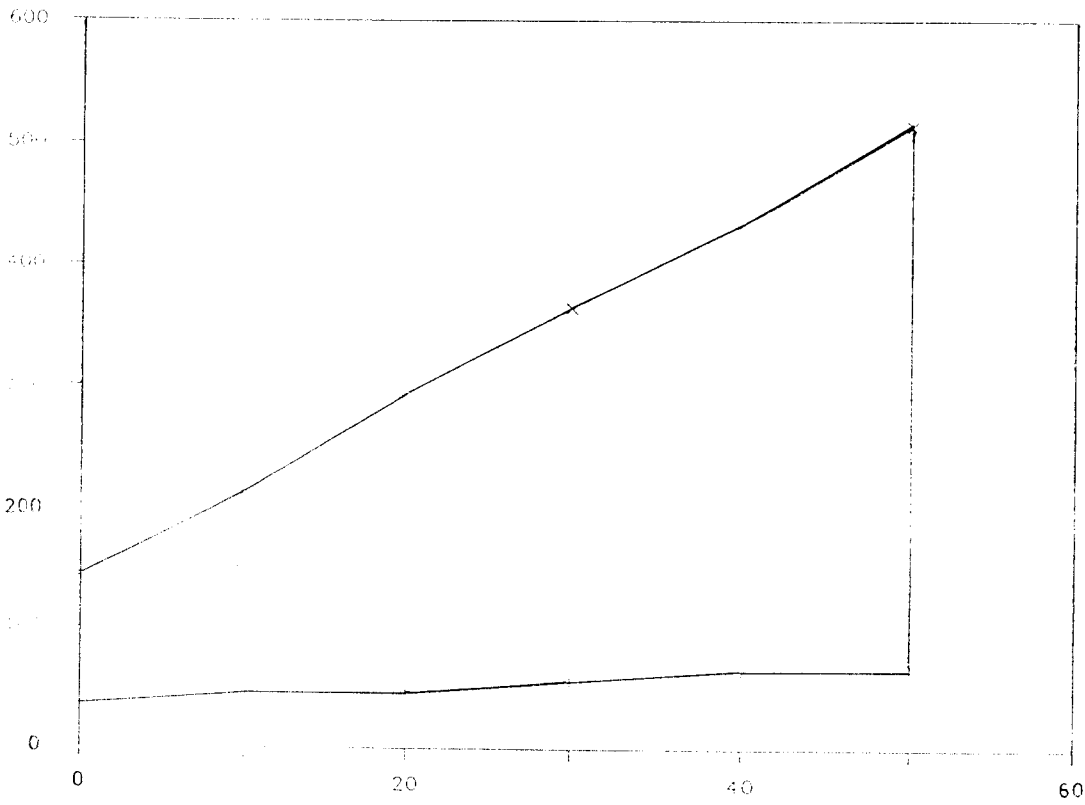

Nimitys Description		Piirustus No Drawing No	Muoto/Form Aines/Material	Mitat/Dimensions	Malli No/Model No	kpi Pcs
Osan lajimerkki/Detail marking						
Korvaa Replacing		Paino/Weight	Suhde/Scale			
Korvattu Replaced by						
Suunn Design by	Liitty Belongs	Piirustus No/Drawing No				
Piirt Drawn by	89.08.15 EH					
Tark Exam. by	Nimitys Description	Assembling of reg. plate			Piirustus No/Drawing No	
Hyy Appr. by	lamp 1165 TALMU	4-12244			page 11	

ANNEXED TO APPROVAL

NO 415

13/10

1989

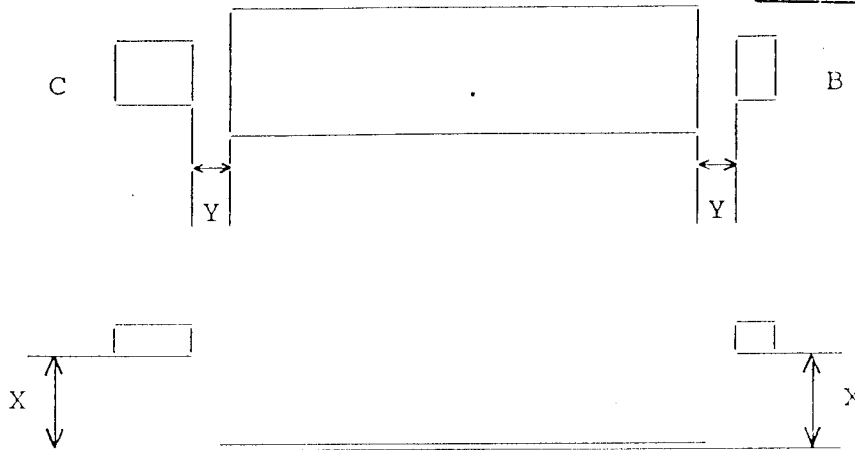

B: TALMU 14 1165
 C: TALMU 14 1130-000

Y / mm

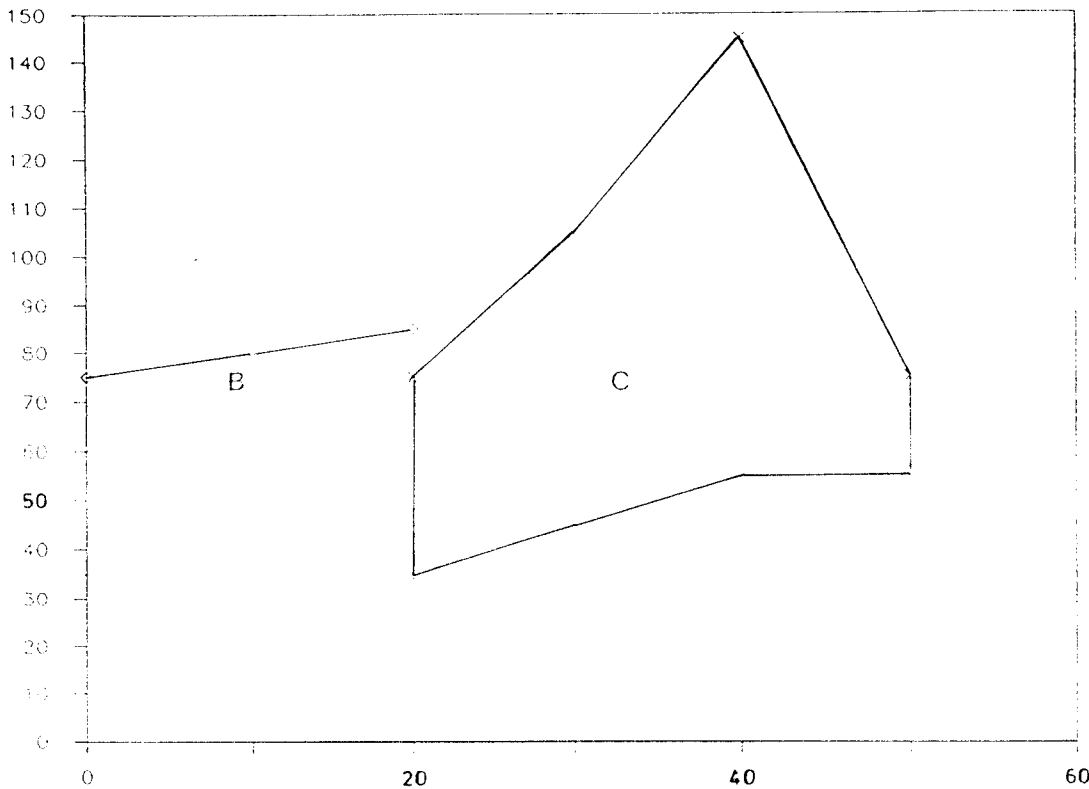

X / mm

Part	Nimitys Drawing No.	Piirustus No Drawing No.	Muoto/Forms Form/Models	Mitat/Dimensions	Malli No/Model No	kpl Pcs
Korvaa Replacing						
Korvattu Replaced by						
Suunn. Design by		Liittyy Belongs	Paino/Weight	Suhde/Scale	Piirustus No/Drawing No	
Piiri Drawn by	89 08 15 EH					
Tark. Exam. by		Nimitys Description	Assembling of 1165	Piirustus No/Drawing No	4-12245	
Hyv. Appr. by		with 1130				page 1

B TALMU 14 1165
 C TALMU 14 1130-000

ANNEXED TO APPROVAL
 NO 415
 13/10 1989

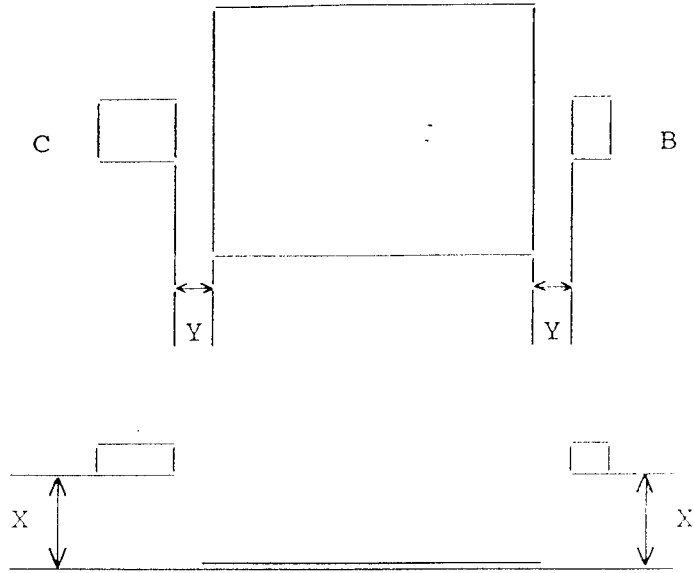

E17

Y / mm

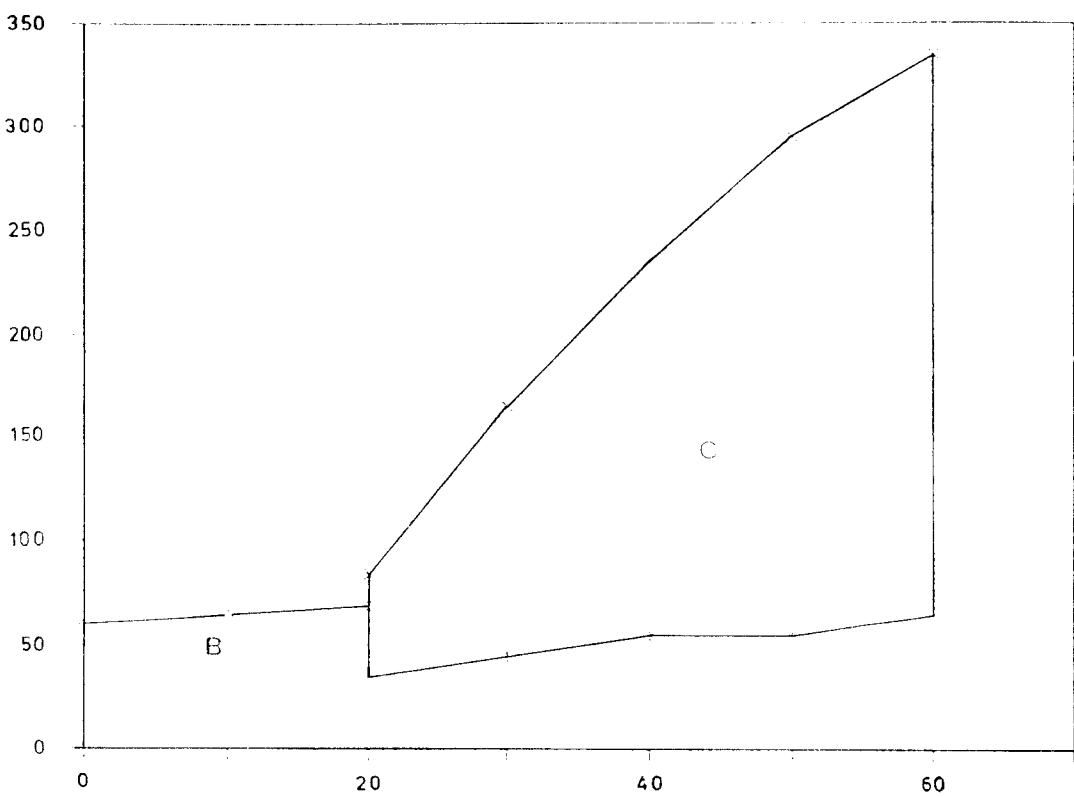

X / mm

Nimitys / Description		Piirustus No / Drawing No	Muoto/ Form / Aine/ Material	Mitat/ Dimensions	Malli No/ Model No	kpl / Pcs
Osan laji/merkki/Detaili/ marking						
Korvaa / Replacing		Paino/ Weight	Suhde/ Scale			
Korvattu / Replaced by						
Suunn. / Design by	Liittyy / Belongs	Piirustus No/ Drawing No				
Part. / Drawn by	89 08 15 EH					
Tark. / Exam. by	Nimitys / Description	Assembling of 1165		Piirustus No/ Drawing No		
Hyv. / Appr. by	with 1130			4-12245	page 2	

B TALMU 14 1165
 D TALMU 14 1153 - 000

ANNEXED TO APPROVAL
 NO 415
 13/10 1989

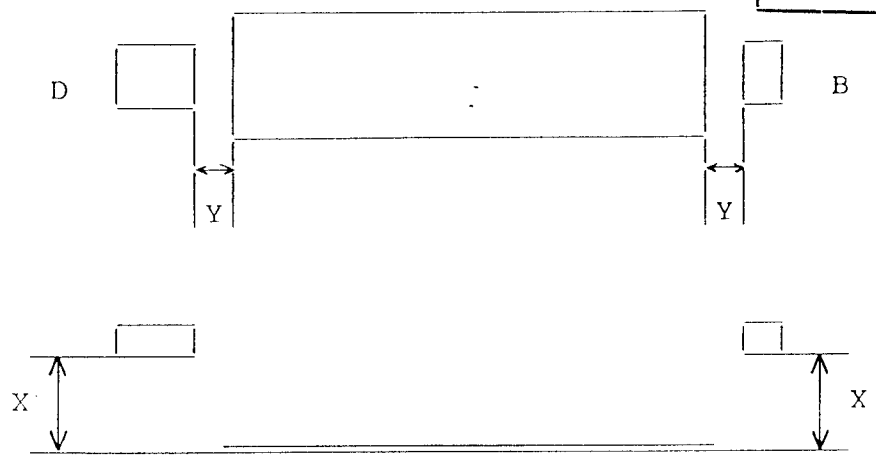

Y / mm

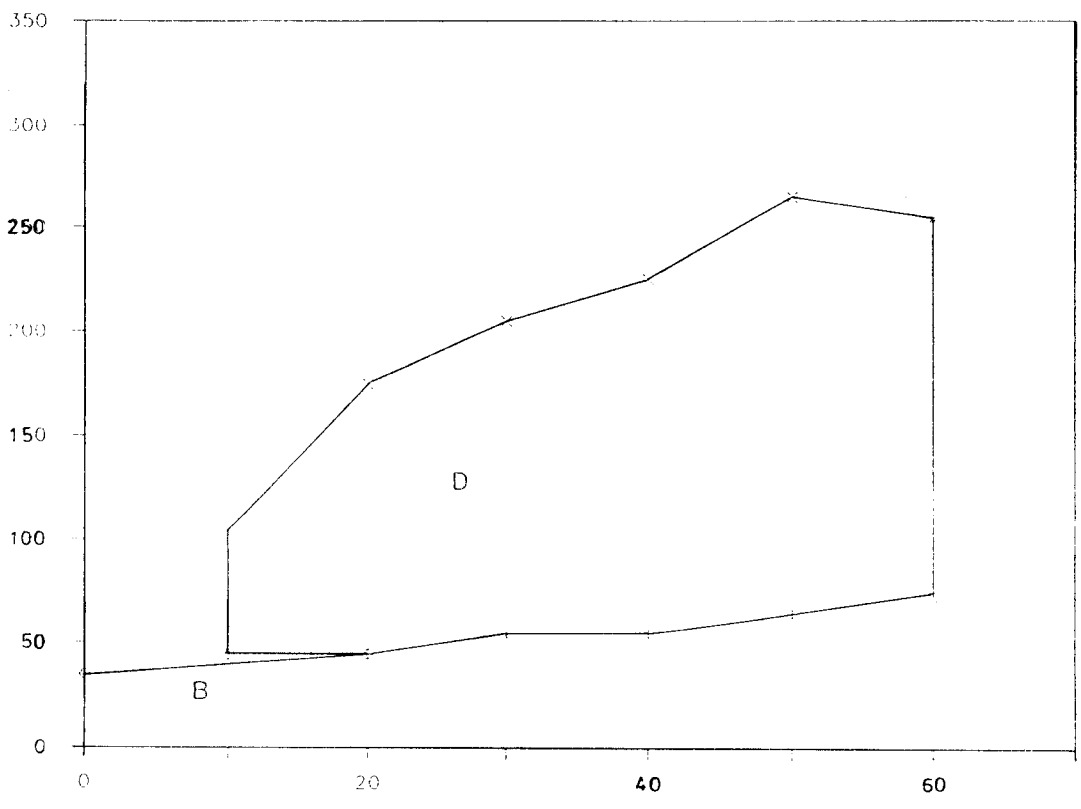

X / mm

Nimitys Description		Piirustus No Drawing No	Muoto/Form Aines/Material	Mitat/Dimensions	Malli No/Model No	kpl Pcs
Osan lajimerkki Detail marking						
Korvaa Replacing		Paino/Weight	Suhde/Scale			
Korvattu Replaced by						
Suunn. Design by	Littyi Belongs		Piirustus No/Drawing No			
Piirt. Drawn by	890816 EH					
Tark. Exam by	Nimitys Description		Assembling of 1165		Piirustus No/Drawing No	
Hyv. Appr. by	with 1153		4-12246		page 1	

B TALMU 14 1165-900
 D TALMU 14 1153-000

ANNEXED TO APPROVAL
 NO 415
 13/10 1989

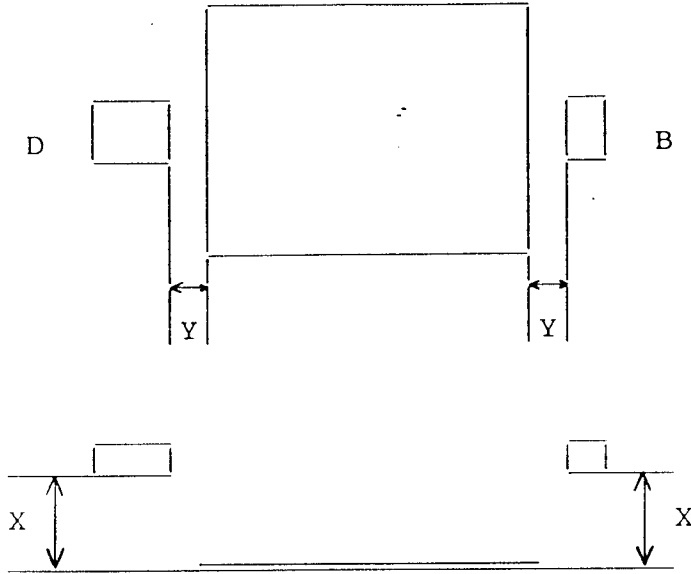

E17

Y / mm

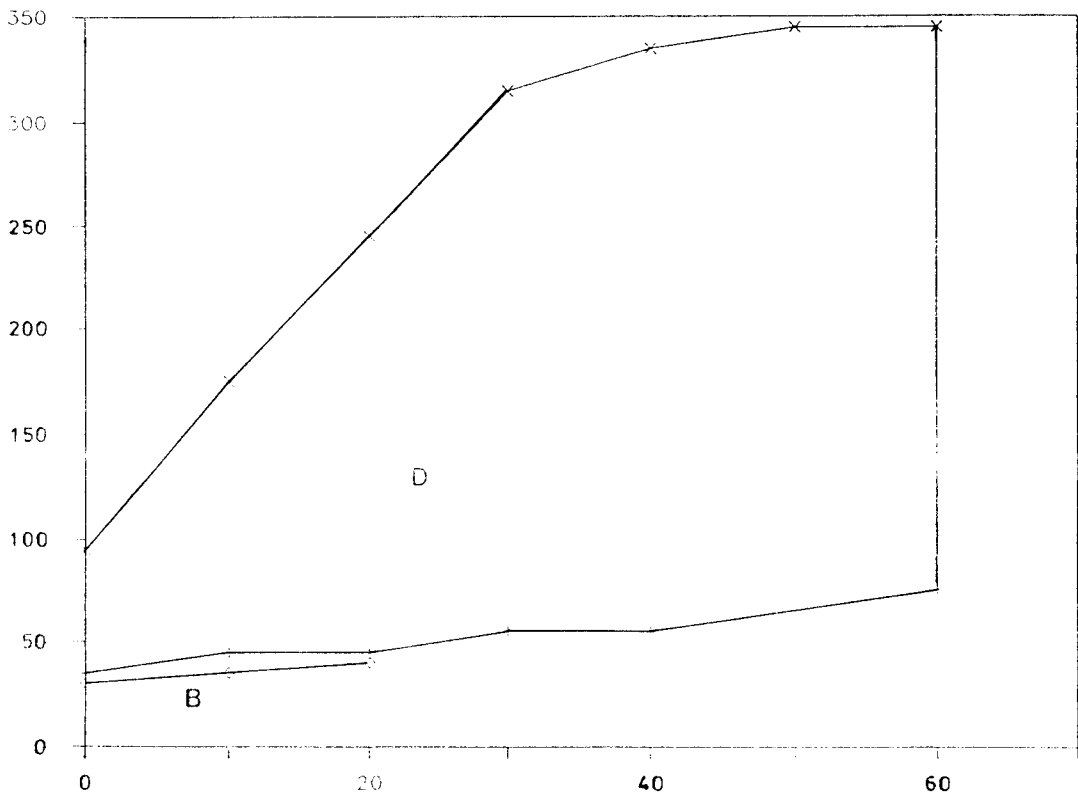

X / mm

Pos	Nimitys Description	Piirustus No Drawing No	Muoto/Form Aines/Material	Mitat/Dimensions	Malli No/Model No	kpl Pcs
Osan lajimerkki/Detail marking						
Korvaa Replacing		Paino/Weight	Suhde/Scale			
Korvattu Replaced by						
Suunn. Design by	Liittyy Belongs		Piirustus No/Drawing No			
Piirt. Drawn by	89 08 16 EH					
Tark. Exam. by	Nimitys Description		Assembling of 1165		Piirustus No/Drawing No	
Hyv. Appr. by	with 1153		4-12246		page 2	