



# Water Heater

## Thermo Top Evo Parking Heater



# Installation Documentation

## Seat Leon

## MQB

### Validity

Manufacturer	Model	Type	Model year	EG BE No. / ABE
Seat	Leon	5F	from 2013 to 2016	e9 * 2007 / 46 * 0094 * ...

Motorisation	Fuel	Emission standard	Transmission type	Output in kW	Displacement in cm <sup>3</sup>	Engine code
1.2 TSI	Petrol	Euro 6	5-speed SG	63	1197	CJZB
1.2 TSI	Petrol	Euro 6	6-speed SG	77	1197	CJZA
1.2 TSI	Petrol	Euro 6	DSG	77	1197	CJZA
1.4 TSI	Petrol	Euro 5	6-speed SG	90	1395	CMBA
1.4 TSI	Petrol	Euro 5	6-speed SG	103	1395	CPTA
1.6 TDI	Diesel	Euro 5	5-speed SG	77	1598	CLHA
1.6 TDI	Diesel	Euro 5	DSG	77	1598	CLHA
1.6 TDI	Diesel	Euro 5	DSG	81	1598	CRKB
2.0 TDI	Diesel	Euro 5	6-speed SG	110	1968	CRMB
2.0 TDI	Diesel	Euro 5	6-speed SG	110	1968	CKFC
2.0 TDI	Diesel	Euro 5	DSG	110	1968	CKFC
2.0 TDI	Diesel	Euro 6	6-speed SG	135	1968	CUPA
2.0 TDI	Diesel	Euro 6	DSG	135	1968	CUPA

Manufacturer	Model	Type	Model year	EG BE No. / ABE
Seat	Leon	5F	from 2017	e9 * 2007 / 46 * 0094 * ...

Motorisation	Fuel	Emission standard	Transmission type	Output in kW	Displacement in cm <sup>3</sup>	Engine code
1.2 TSI	Petrol	Euro 6	6-speed SG	81	1197	CYVB
1.4 TSI	Petrol	Euro 6	6-speed SG	110	1395	CZEA
1.4 TSI	Petrol	Euro 6	7-speed DSG	110	1395	CZEA
1.8 TSI	Petrol	Euro 6	7-speed DSG	132	1798	CJSA
2.0 TDI	Diesel	Euro 6	6-speed SG	110	1968	CRLB
2.0 TDI	Diesel	Euro 6	DSG	110	1968	CRLB
2.0 TDI	Diesel	Euro 6	6-speed SG	135	1968	CUNA

SG = manual transmission  
 DSG = direct gear transmission

## Seat Leon

### Left-hand drive vehicle

#### Verified equipment variants:

Climatic  
Climatronic  
Front fog lights  
Headlight washer system  
LED daytime running lights  
Full LED headlamps  
Xenon  
LED front fog lights  
Start - Stop  
2WD / 4WD

#### Not verified:

Passenger compartment monitoring

#### Total installation time:

approx. 7.5 hours

# Seat Leon

## Table of Contents

Validity	1	Preparing Installation Location	13
Necessary Components	3	Installing Heater Assembly	16
Installation Instructions	3	Fuel	23
Information on Total Installation Time	3	FuelFix Installation for TSI	28
Information on Operating and Installation Instructions	4	FuelFix Installation for TDI	31
Information on Validity	5	Coolant Circuit of TSI	35
Technical Information	5	Coolant Circuit of TDI 2WD	42
Explanatory Notes on Document	5	Coolant Circuit of TDI 4WD	46
Preliminary Work	6	Final Work	50
Heater Assembly Installation Location	6	FuelFix Template for TSI	52
Preparing Electrical System	7	FuelFix Template for TDI	53
Electrical System	9		
Air-Conditioning Control	10		
Heater Control Elements	10		
MultiControl CAR Option	10		
Remote Option (Telestart)	10		
ThermoCall Option	11		

## Necessary Components

Description	Order No.:
Delivery scope for VW / Skoda / Seat MQB A/B from model year 2013, petrol	1325108B
Delivery scope for VW / Skoda / Seat MQB A/B from model year 2013, diesel	1325106B
In case of 1.8 TSi petrol: Additional kit for exhaust system for Skoda/Seat MQB 1.8, petrol	1325955_
Additional kit 'Webasto Standard' for VW / Skoda / Seat MQB air-conditioning control, Climatic and Climatronic or Additional kit 'Webasto Comfort' for VW / Skoda / Seat MQB air-conditioning control, Climatronic	1325085_ 1325012_
In case of Telestart, heater control, as well as indicator lamp in consultation with end customer	In accordance with price list

## Webasto Individual Option

Description	Order No.:
Webasto Individual Auxiliary Heating additional kit	1320077_
Webasto Individual Quick additional kit	9030826_
Webasto Individual Select additional kit	9030828_

## Installation Instructions

Arrange for the vehicle to be delivered with the tank only about ¼ full.

The installation location of the push button in case of Telestart or ThermoCall should be confirmed with the end customer.

Depending on the space required and the vehicle manufacturer's instructions, we recommend the use of a vehicle battery with a higher electrical capacity.

When installing the premounted heater assembly, ensure sufficient distance to the original vehicle components, correct if necessary.

## Information on Total Installation Time

The total installation time includes the time needed for mounting and demounting the vehicle-specific components, the heater specific installation time and all other times required for the system integration and initial start-up of the heater.

The total installation time may vary for vehicle equipment other than provided.

## Information on Operating and Installation Instructions

### 1 Important information (not complete)

#### 1.1 Installation and repair



The improper installation or repair of Webasto heating and cooling systems can cause fire or the leakage of deadly carbon monoxide, leading to serious injury or death.



To install and repair Webasto heating and cooling systems you need to have completed a special company training course and have the appropriate technical documentation, special tools and special equipment.



Installation and repair may ONLY be carried out by persons trained and certified in a Webasto training course. NEVER try to install or repair Webasto heating or cooling systems if you have not completed a Webasto training course, you do not have the necessary technical skills and you do not have the technical documentation, tools and equipment available to ensure that you can complete the installation and repair work properly.

Only use genuine Webasto parts. See the Webasto air and water heaters accessories catalogue for this purpose.

#### 1.2 Operation

To ensure safe operation, we recommend having the heater checked every two years by an authorised Webasto dealer, especially when used over a long period and/or under extreme environmental conditions.

Do not operate the heater in closed rooms due to the danger of poisoning and suffocation.

Always switch off the heater before refuelling.

The heater may only be used with the prescribed fuel diesel (DIN EN 590) or petrol (DIN EN 228).

The heater may not be cleaned with a high-pressure cleaner.

#### 1.3 Please note

ALWAYS follow all Webasto installation and operating instructions and observe all warnings.

To become familiar with and understand all functions and properties of the heater, the operating instructions must be read carefully and observed at all times.

For proper, safe installation and repair work, the installation instructions with all warnings and safety information must be carefully read and observed at all times. Please always contact a workshop authorised by Webasto for all installation and repair work.

#### Important

**Webasto shall assume no liability for defects, damage and injuries resulting from a failure to observe the installation, repair and operating instructions of the information contained in them.**

**This liability exclusion particularly applies to improper installations and repairs, installations and repairs by untrained persons or in the case of a failure to use genuine spare parts.**

**The liability due to culpable disregard to life, limb or health and due to damage or injuries caused by a wilful or reckless breach of duty remain unaffected, as does the obligatory product liability.**

Installation should be carried out according to the general, standard rules of technology. Unless specified otherwise, fasten hoses, lines and wiring harnesses to original vehicle lines and wiring harnesses using cable ties. Insulate loose wire ends and tie back. Connectors on electronic components must audibly snap into place during assembly.

Sharp edges should be fitted with rub protection. Spray unfinished body areas, e.g. drilled holes, with anti-corrosion wax (Tectyl 100K).

Observe the instructions and guidelines of the respective vehicle manufacturer for demounting and mounting vehicle specific components!

The initial startup is to be executed with the Webasto Thermo Test Diagnosis.

When installing a programmable control module (e.g. a PWM Gateway), the corresponding settings must be checked or adjusted.

### 2 Statutory regulations governing installation

Guidelines	Thermo Top Evo
Heating Directive ECE R122	E1 00 0258
EMC Directive ECE R10	E1 04 5627

#### Note

The regulations of these guidelines are binding in the scope of the Directive 70/156/EEC and/or 2007/46/EC (for new vehicle models from 29/04/2009) and should also be observed in countries in which there are no special regulations.

#### Important

Failure to follow the installation instructions will result in the invalidation of the type approval for the heater and therefore invalidation of the general **homologation of the vehicle**.

#### Note

The heater is licensed in accordance with paragraph 19, section 3, No. 2b of the StVZO (German Road Traffic Licensing Authority).

### 2.1 Excerpt from ECE regulation 122 (heating system) paragraph 5 for the installation of the heater

Beginning of excerpt.

#### ANNEX VII

#### REQUIREMENTS FOR COMBUSTION HEATERS AND THEIR INSTALLATION

##### 1. GENERAL REQUIREMENTS

1.7.1. A clearly visible tell-tale in the operator's field of view shall inform when the combustion heater is switched on or off.

##### 2. VEHICLE INSTALLATION REQUIREMENTS

###### 2.1. Scope

2.1.1. Subject to paragraph 2.1.2, combustion heaters shall be installed according to the requirements of this Annex.

2.1.2. Vehicles of category O having liquid fuel heaters are deemed to comply with the requirements of this Annex.

###### 2.2. Positioning of heater

2.2.1. Body sections and any other components in the vicinity of the heater must be protected from excessive heat and the possibility of fuel or oil contamination.

2.2.2. The combustion heater shall not constitute a risk of fire, even in the case of overheating. This requirement shall be deemed to be fulfilled if the installation ensures an adequate distance to all parts and suitable ventilation, by the use of fire resistant materials or by the use of heat shields.

2.2.3. In the case of M2 and M3 vehicles, the heater must not be positioned in the passenger compartment. However, an installation in an effectively sealed envelope which also complies with the conditions in paragraph 2.2.2 may be used.

2.2.4. The label referred to in paragraph 1.4 or a duplicate, must be positioned so that it can be easily read when the heater is installed in the vehicle.

2.2.5. Every reasonable precaution should be taken in positioning the heater to minimise the risk of injury and damage to personal property.

###### 2.3. Fuel supply

2.3.1. The fuel filler must not be situated in the passenger compartment and must be provided with an effective cap to prevent fuel spillage.

2.3.2. In the case of liquid fuel heaters, where a supply separate to that of the vehicle is provided, the type of fuel and its filler point must be clearly labelled.

2.3.3. A notice, indicating that the heater must be shut down before refuelling, must be affixed to the fuelling point. In addition a suitable instruction must be included in the manufacturer's operating manual.

###### 2.4. Exhaust system

2.4.1. The exhaust outlet must be located so as to prevent emissions from entering the vehicle through ventilators, heated air inlets or opening windows.

###### 2.5. Combustion air inlet

2.5.1. The air for the combustion chamber of the heater must not be drawn from the passenger compartment of the vehicle.

2.5.2. The air inlet must be so positioned or guarded that blocking by rubbish or luggage is unlikely.

###### 2.6. Heating air inlet

2.6.1. The heating air supply may be fresh or recirculated air and must be drawn from a clean area not likely to be contaminated by exhaust fumes emitted either by the propulsion engine, the combustion heater or any other vehicle source.

2.6.2. The inlet duct must be protected by mesh or other suitable means.

###### 2.7. Heating air outlet

2.7.1. Any ducting used to route the hot air through the vehicle must be so positioned or protected that no injury or damage could be caused if it were to be touched.

2.7.2. The air outlet must be so positioned or guarded that blocking by rubbish or luggage is unlikely.

End of excerpt.

In multilingual versions the German language is binding.

## Information on Validity

This installation documentation applies to Seat Leon Petrol and diesel vehicles - for validity, see page 1 and 2 - from model year 2013 and later, assuming technical modifications to the vehicle do not affect installation, any liability claims excluded. Depending on the vehicle version and equipment, modifications may be necessary during installation with respect to this 'installation documentation'.

Vehicle and engine types, equipment variants and other specifications not listed in this installation documentation have not been tested. However, installation according to this installation documentation may be possible.

## Technical Information

### Special Tools

- Hose clamp pliers for auto-tightening hose clamps
- Hose clamp pliers for Clic hose clamps of type W
- Automatic wire stripper, 0.2 - 6mm<sup>2</sup>
- Crimping pliers for cable lug / tab connector, 0.5 - 6mm<sup>2</sup>
- Torque wrench for 2.0 - 10 Nm
- Hose clamping pliers
- Metric thread-setter kit
- Deep-hole marker
- Webasto Thermo Test Diagnosis with current software

### Dimensions

- All dimensions are in mm.

### Tightening torque values

- Tighten screw connections in accordance with manufacturer's instructions or in accordance with state-of-the-art-technology.

## Explanatory Notes on Document

You will find an identification mark on the outside top right corner of the page in question to provide you with a quick overview of the individual working steps.

### Mechanics



### Electrics



### Coolant Circuit



### Combustion Air

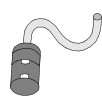

### Fuel



### Exhaust Gas



### Software



Special features are highlighted using the following symbols:

Specific risk of damage to components.



Specific risk due to electrical voltage.



Specific risk of fire or explosion.



Reference to a special technical feature.



The arrow in the vehicle icon indicates the position on the vehicle and the viewing angle.

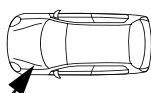

Reference to the manufacturer's vehicle-specific documents.



Reference to specific installation instructions of Webasto components (demonstrated with the example of the FuelFix).



Reference to general installation instructions of Webasto components.



Tightening torque according to the manufacturer's vehicle-specific documents.



## Preliminary Work

### Vehicle

- Open the fuel tank cap.
- Ventilate the fuel tank.
- Close the fuel tank cap again.
- Depressurise the cooling system.
- Disconnect and remove the battery completely together with the carrier.
- Completely remove the air filter box together with the intake hose.
- Remove the engine underride protection.
- Remove the right underride protection.
- Remove the fuel tank underride protection, if present.
- Remove the right front wheel.
- Remove the front right wheel well trim.
- Completely remove the horns with the bracket (depending on equipment variant).
- Remove the lateral instrument panel trim on the driver's side.
- Remove the A-pillar trim on the driver's side (in case of Telestart).
- Remove the footwell trim on the front passenger's side.
- Remove the rear seats.
- Open the right-hand tank-fitting service lid.



### Heater

- Remove years that do not apply from the type and duplicate label.
- Attach the duplicate label (type label) visibly in the appropriate place in the engine compartment.

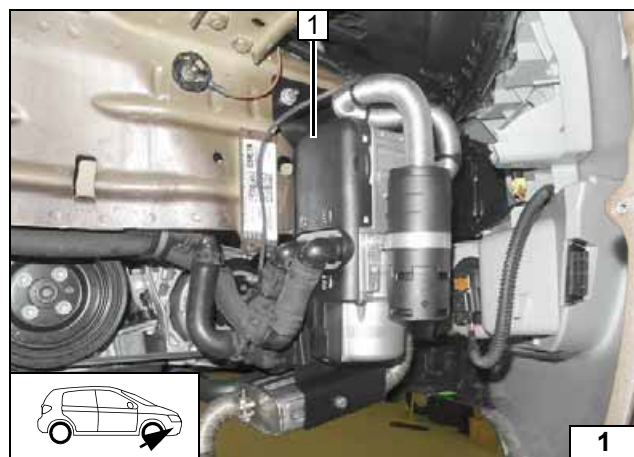

### Heater Assembly Installation Location

- 1 Heater assembly



Installation location

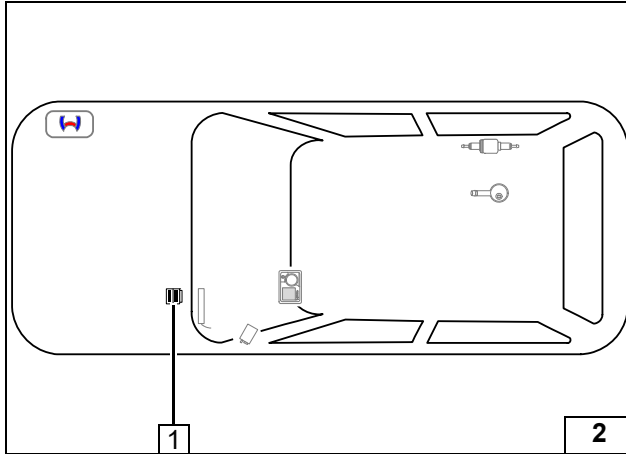

## Preparing Electrical System

- 1 Engine compartment fuse holder



Installation overview

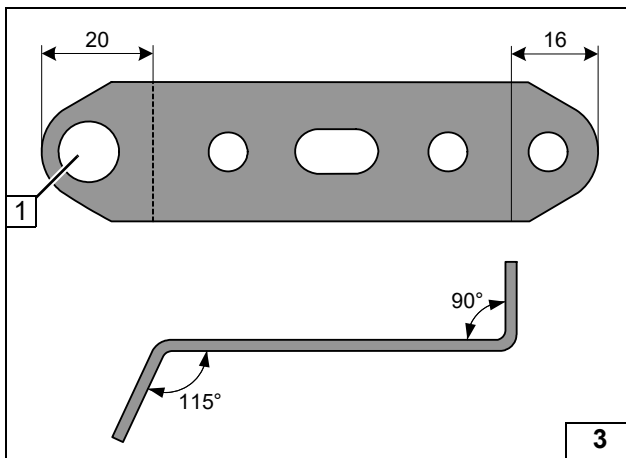

- 1 Drill out hole to 12.5mm dia.

Preparing perforated bracket

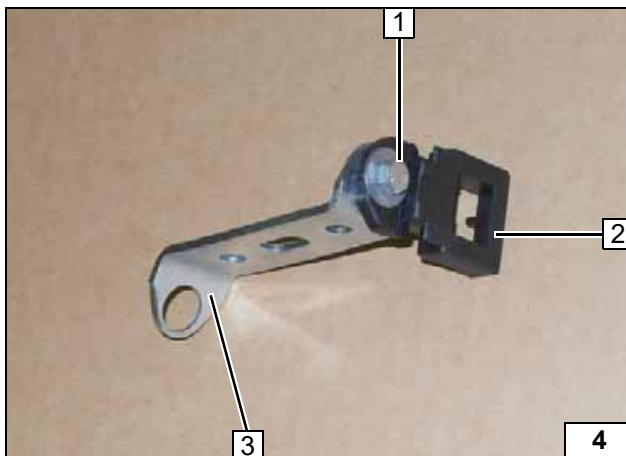

- 1 M5x16 bolt, washer [2x], nut
- 2 Fuse holder retaining plate
- 3 Perforated bracket

Premounting engine compartment fuse holder

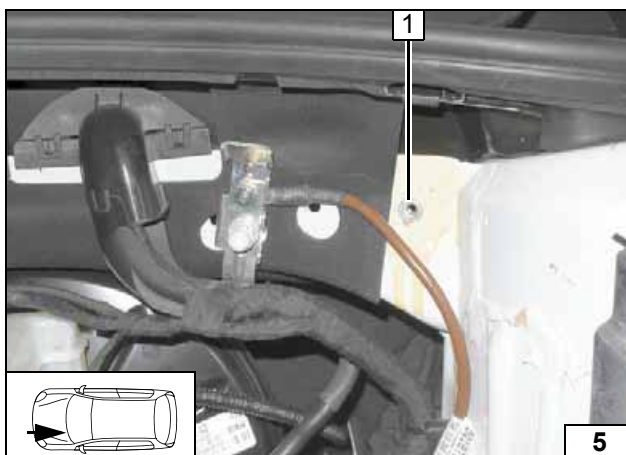

- 1 Drill out existing hole to 9mm dia.; rivet nut

Installing rivet nut

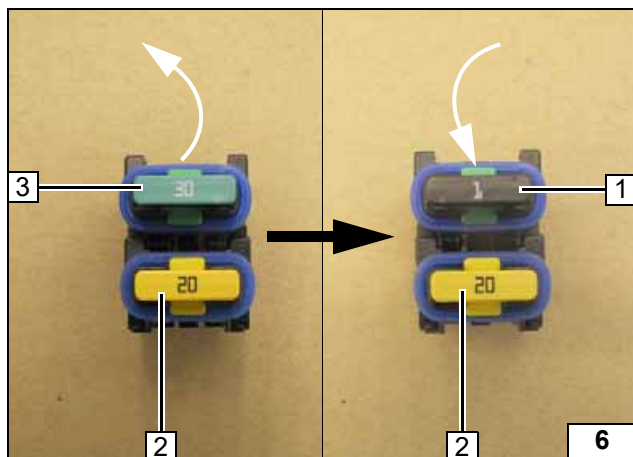

Replace passenger compartment 30A main fuse F2 **3** with 1A fuse **1**.

**2** 20A heater fuse F1

**Preparing engine compartment fuses**

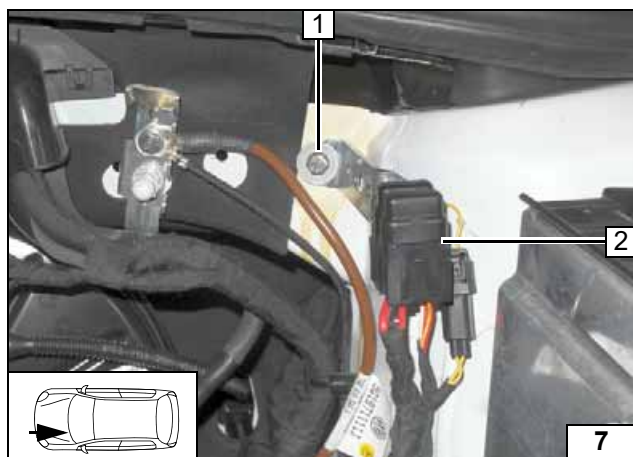

**1** M6x20 bolt, spring lockwasher, large diameter washer

**2** Fuses F1-2

**Mounting engine compartment fuse holder**





**Electrical System**



**Wiring harness routing**

Route heater wiring harness under the cover at the marking to the heater installation location and attach with retaining clamp 1 [3x].

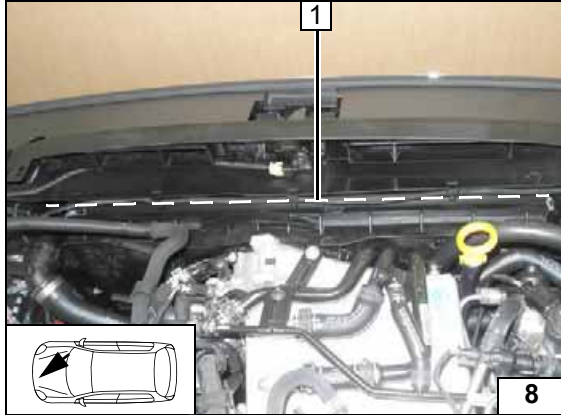

**Earth wire**

1 Earth wire on original vehicle earth support point

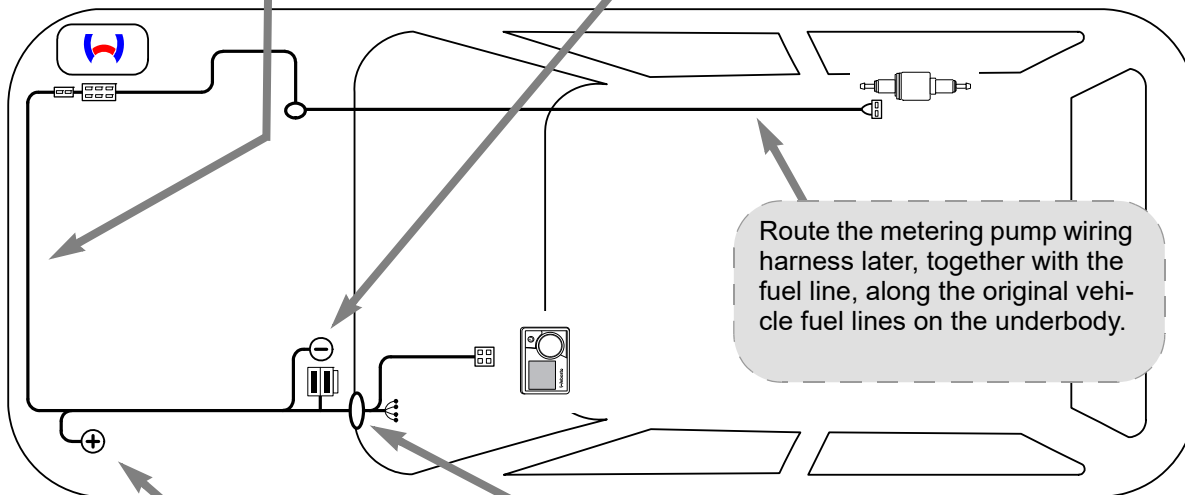
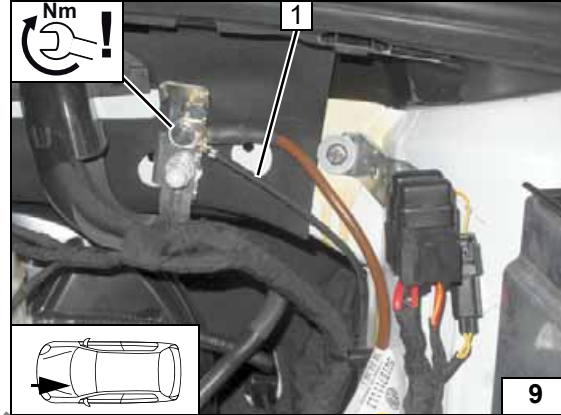

**Wiring harness routing diagram**

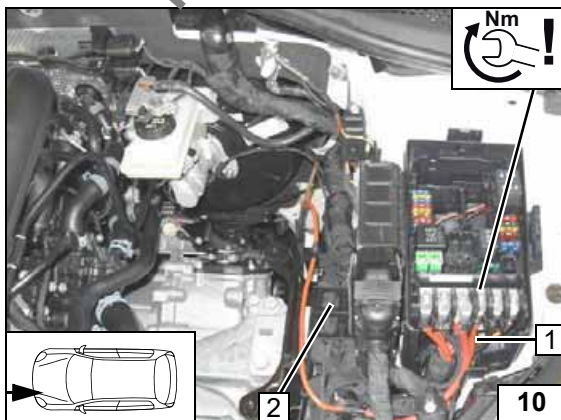

**Positive wire**

- 1 Positive wire on positive distributor
- 2 Wiring harnesses in original vehicle line duct

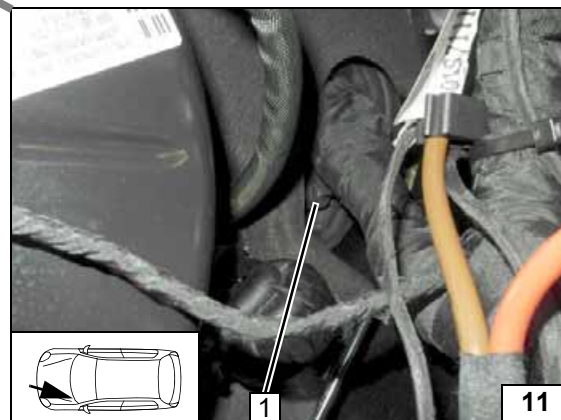

**Wiring harness pass through**

Route heater wiring harnesses and heater control through protective rubber plug 1 to the passenger compartment.





## Air-Conditioning Control



Integrate the A/C control as explained in the separate installation documentation:

'Webasto Standard' installation documentation for VW / Skoda / Seat MQB Climatic and Climatronic air-conditioning control

or

'Webasto Comfort' installation documentation for VW / Skoda / Seat MQB Climatronic air-conditioning control

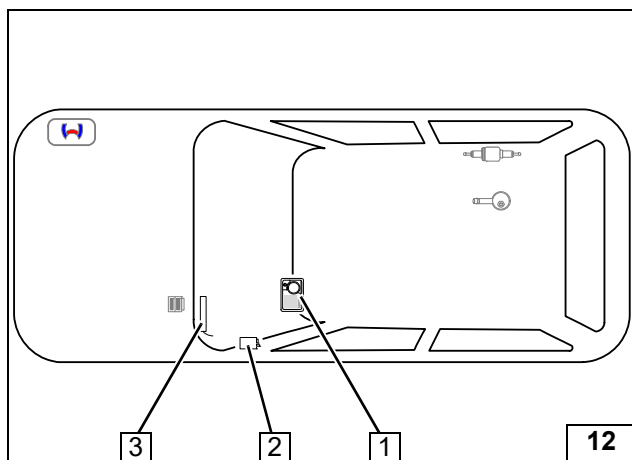

## Heater Control Elements

- 1 MultiControl CAR
- 2 Teletstart / ThermoCall receiver
- 3 Teletstart / ThermoCall aerial

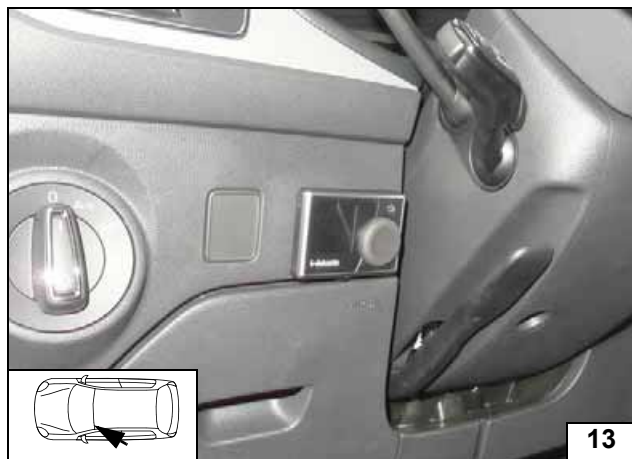

## MultiControl CAR Option

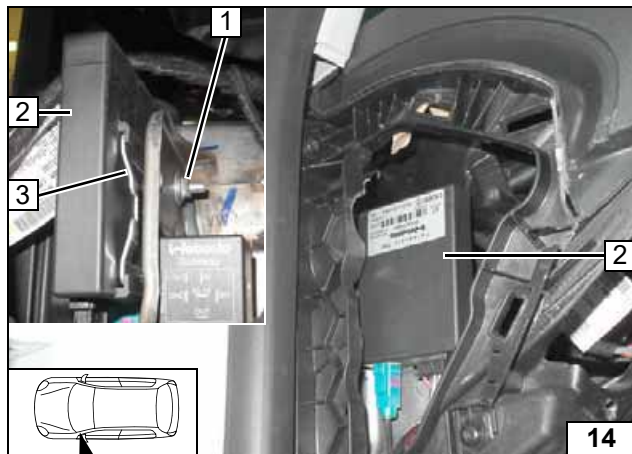

## Remote Option (Teletstart)

- 1 M5x16 bolt, large diameter washer, nut, existing hole
- 2 Receiver
- 3 Receiver bracket



Installation overview



Installing MultiControl CAR



Installing receiver

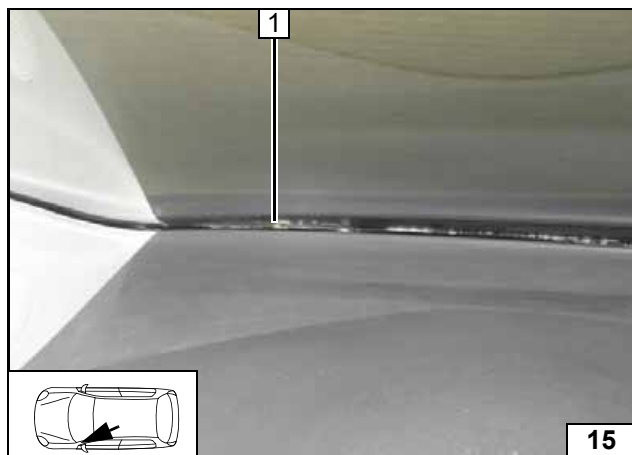

1 Aerial

Installing aerial

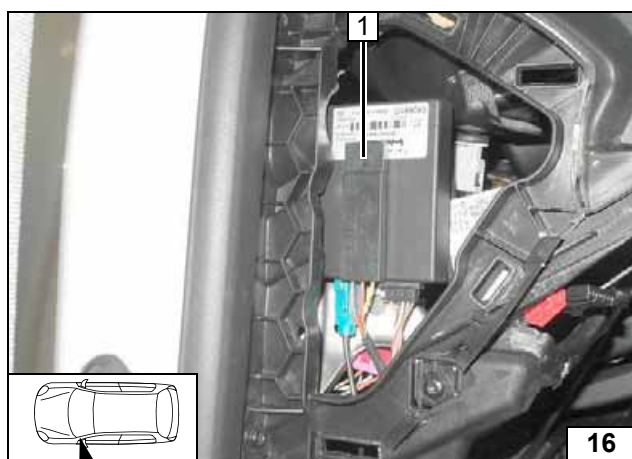

**Temperature sensor T100 HTM**

Fasten temperature sensor 1 with double-sided adhesive tape.



Installing temperature sensor

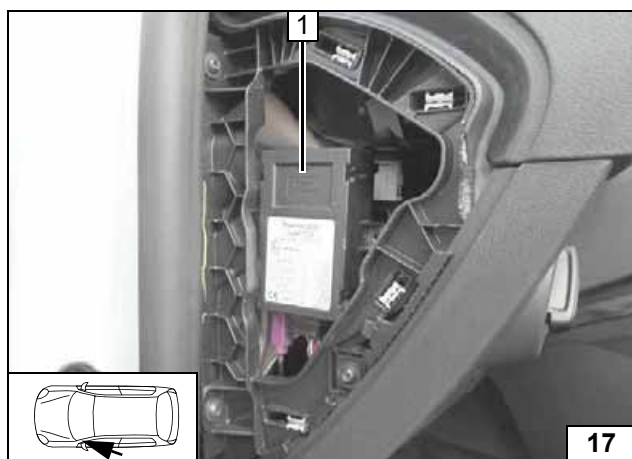

**ThermoCall Option**

Fasten receiver 1 with double-sided adhesive tape.



Installing receiver

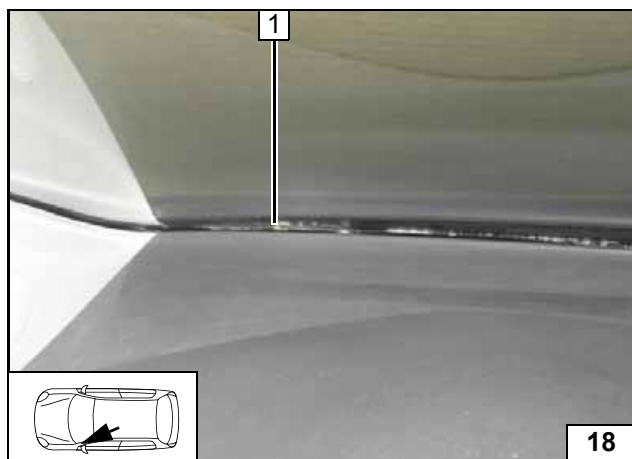

1 Aerial (optional)

Installing aerial

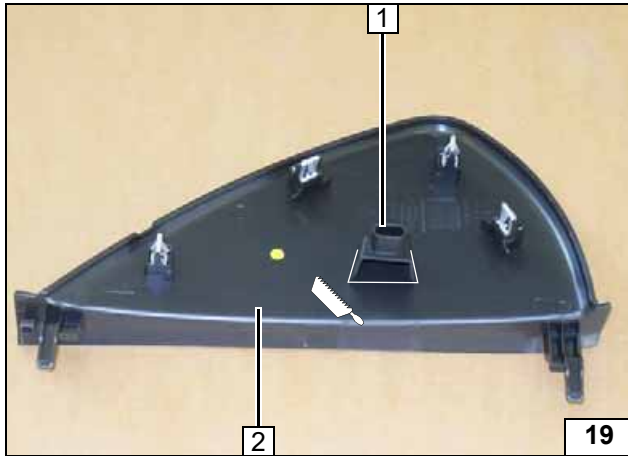
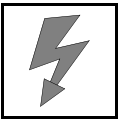

Cut blind nut **1** flush off lateral instrument panel trim **2**.



**Preparing lateral instrument panel trim**

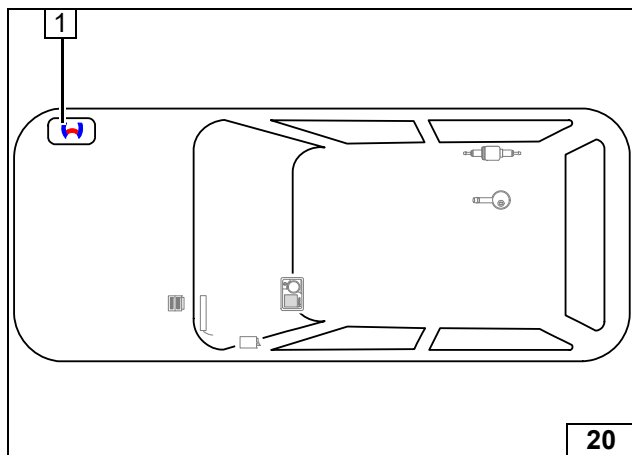
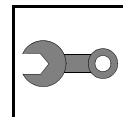

### Preparing Installation Location

- 1 Heater assembly



Installation overview

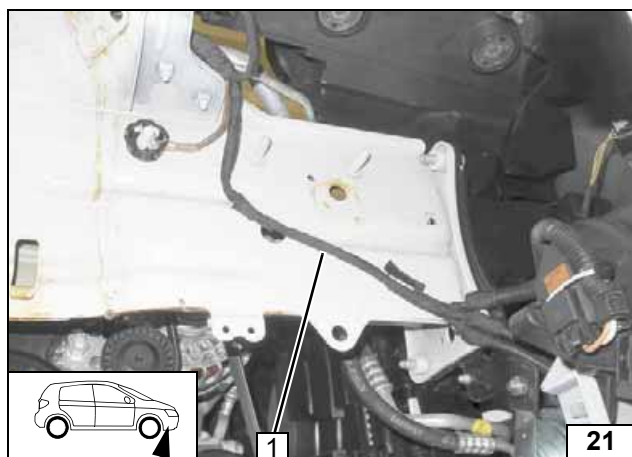

Detach original vehicle wiring harness 1 with clip.



Detaching wiring harness



Reroute original vehicle wiring harness 1 as shown.



Aligning wiring harness

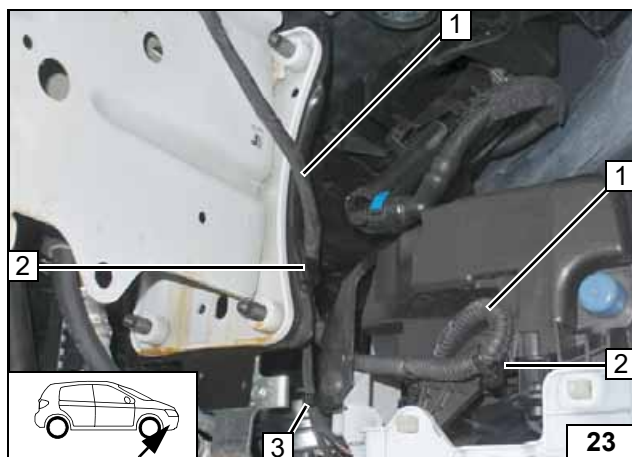

- 1 Original vehicle wiring harness
- 2 Clip-type cable tie [2x]
- 3 Cable tie

Fastening wiring harness

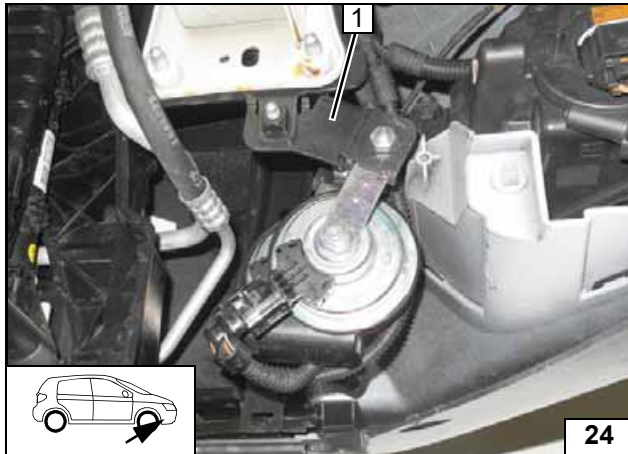
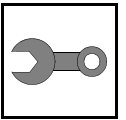

**Version 1**

Remove horns with bracket 1.



**Removing horns**

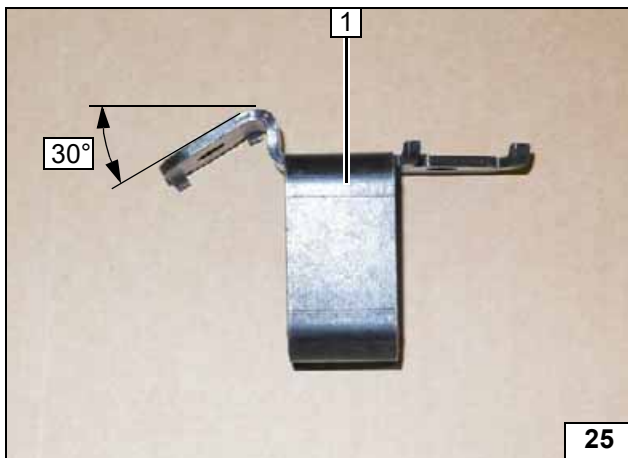

Bend tab down at an angle of 30°.

1 Bracket of horns



**Aligning horn bracket**

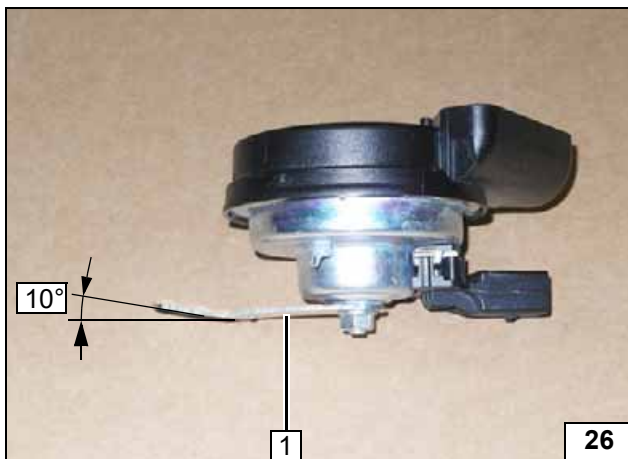

Angle bracket of horn b 1 by 10°.



**Bending bracket at an angle**

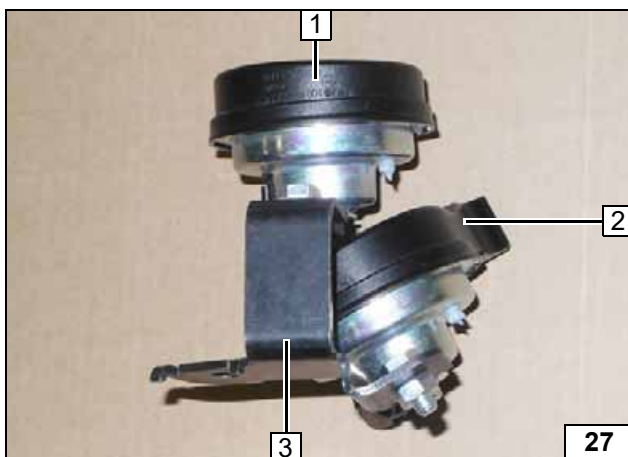

- 1 Horn b
- 2 Horn a
- 3 Bracket of horns

**Completing bracket with horns**

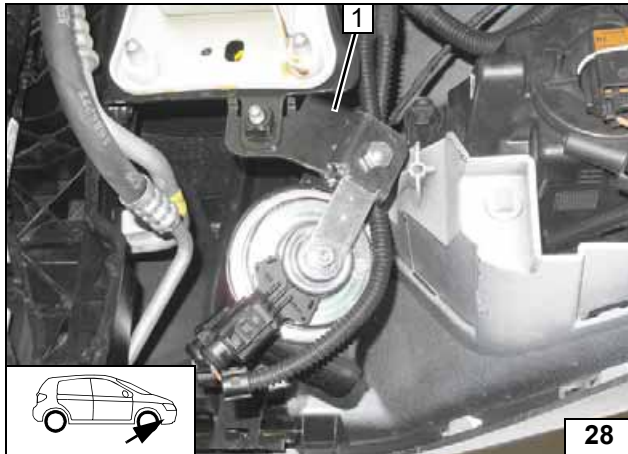
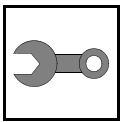

Install horns with bracket 1.



Installing horns

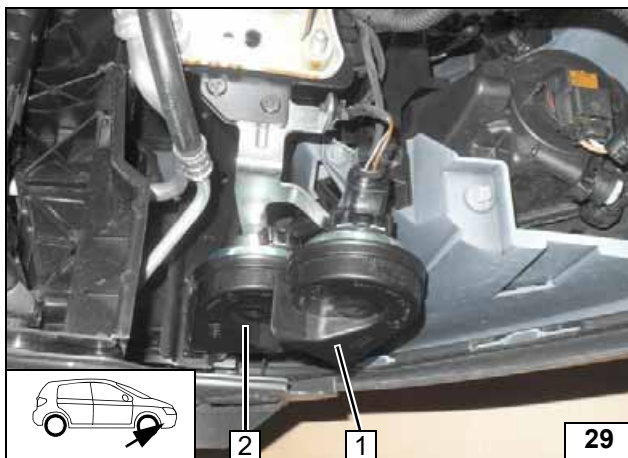

Version 2

- 1 Horn b
- 2 Horn a

Removing horns

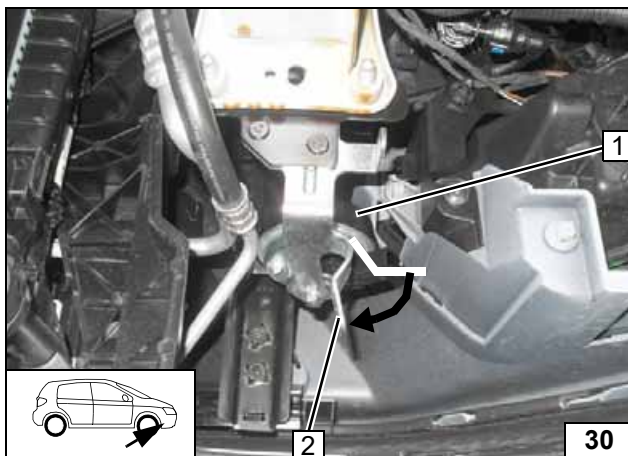

Bend tab 2 of bracket downwards as shown.



- 1 Top of horn bracket a adapted, bent by 180°

Bending bracket, installing horn

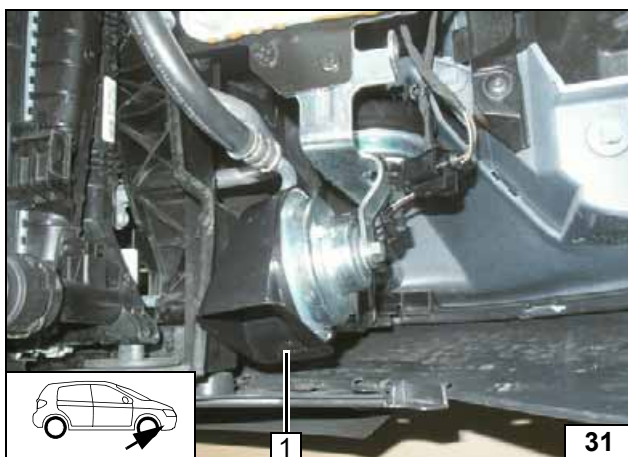

Ensure freedom of movement, correct if necessary.



- 1 Horn b

Installing horn

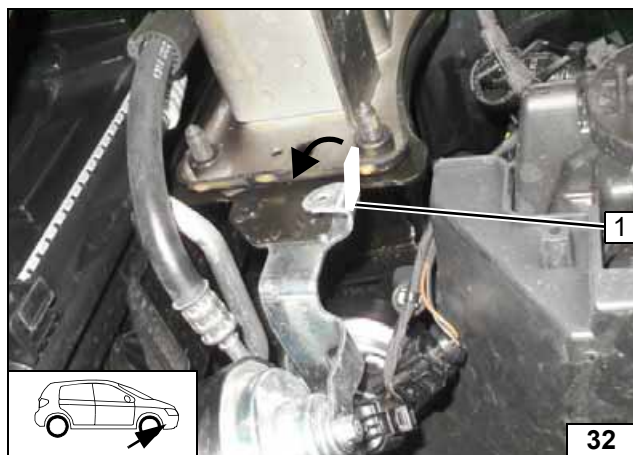
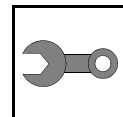

Bend tab 1 of bracket to the left as shown.



Bending tab

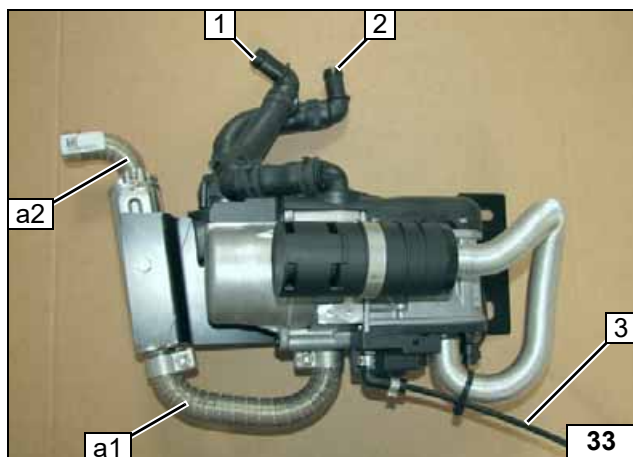

### Installing Heater Assembly

- 1 Heater outlet connection
- 2 Heater inlet connection
- 3 Fuel line
- a1 Exhaust pipe
- a2 Exhaust pipe



Heater assembly



### Except for 1.8 petrol vehicles

- 1 Detach hose clamp [2x], will be re-used



Dismantling exhaust pipe a1

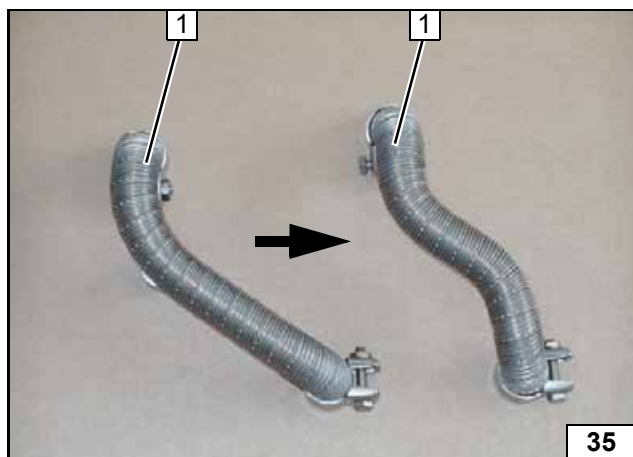

- 1 Heater connection side



Remoulding exhaust pipe a1



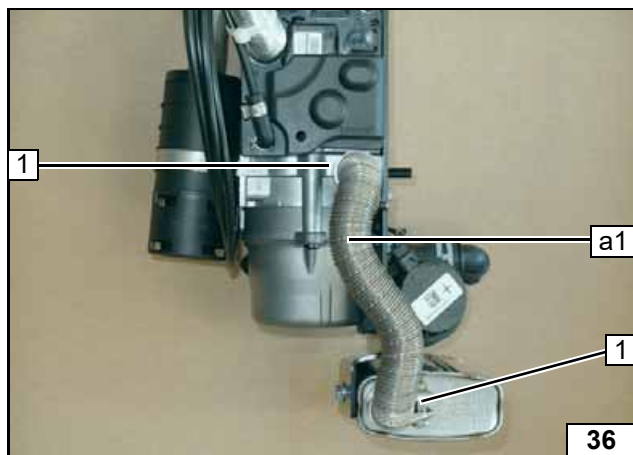
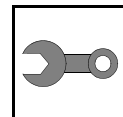

1 Hose clamp [2x]



Installing exhaust pipe a1



Remove bolt 1, insert 5mm shim 2 between silencer and bracket and tighten the bolt again.



Mounting shim

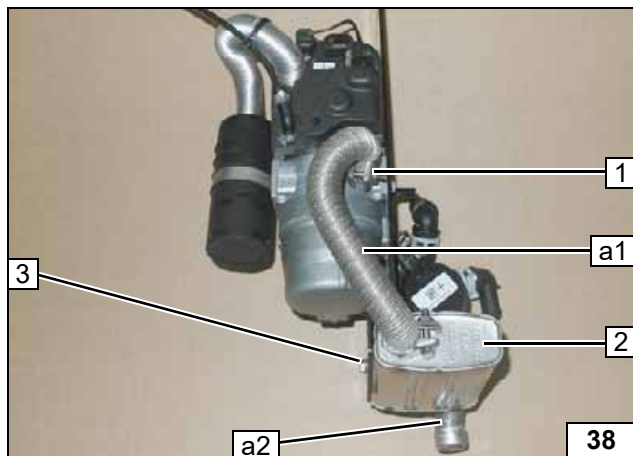

1.8 petrol vehicles only

remove hose clamp 1 and bolt 3, will be used again.



2 Silencer

Removing exhaust silencer, exhaust pipes a1 and a2

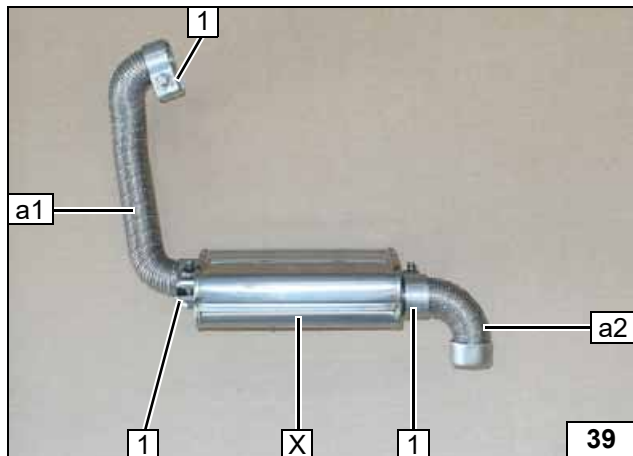

Exhaust pipe a1, a2 and hose clamp 1 [3x] will be needed again.



X =

Removing exhaust pipes a1 and a2

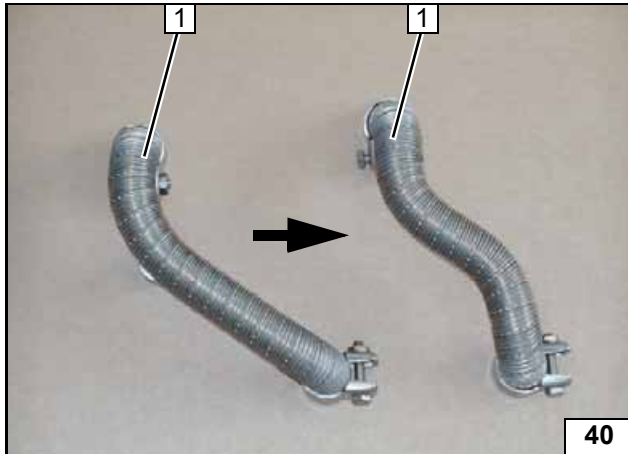
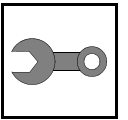

1 Heater connection side



Remoulding  
exhaust pipe  
a1

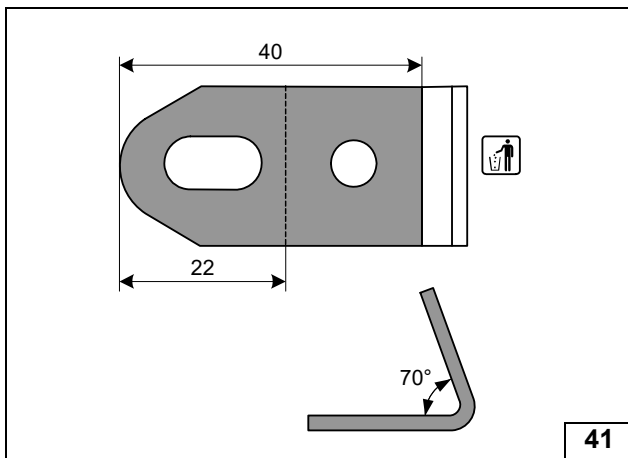

Preparing  
angle  
bracket

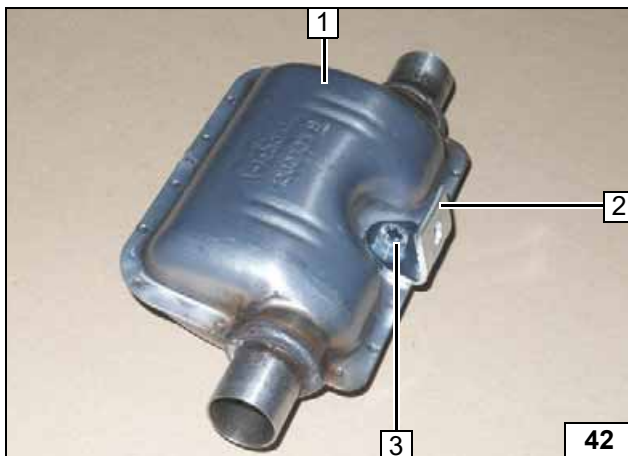

- 1 Silencer, new
- 2 Angle bracket
- 3 M6x16 bolt, flanged nut

Installing  
angle  
bracket



1 Hose clamp

Installing  
exhaust  
pipe a2

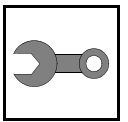

- 1 M6x12 bolt, flanged nut
- 2 Heater bracket

**Installing silencer**

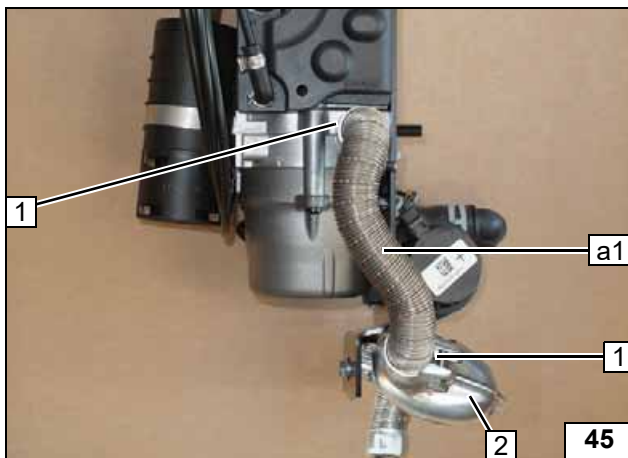

- 1 Hose clamp [2x]
- 2 Exhaust silencer

**Installing exhaust pipe a1**

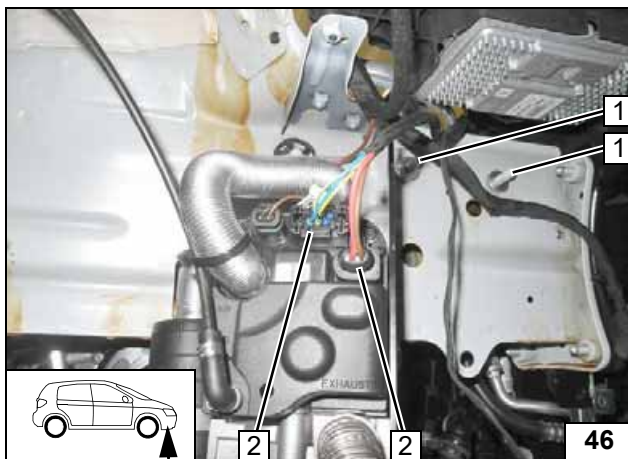

**Version 1 with original vehicle stud bolt**

- 1 View of original vehicle stud bolt [2x]
- 2 Heater wiring harness connector [2x]

**Mounting wiring harness**

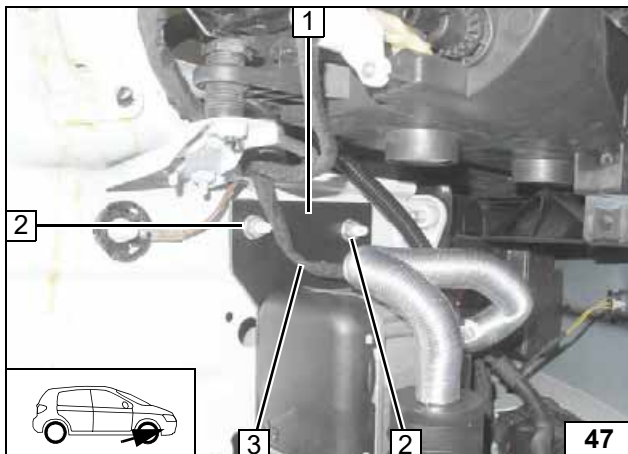

Route original vehicle wiring harness **3** in front of bracket **1** as shown.

- 2 Original vehicle stud bolt, M8 flanged nut [2x each]

**Installing heater**

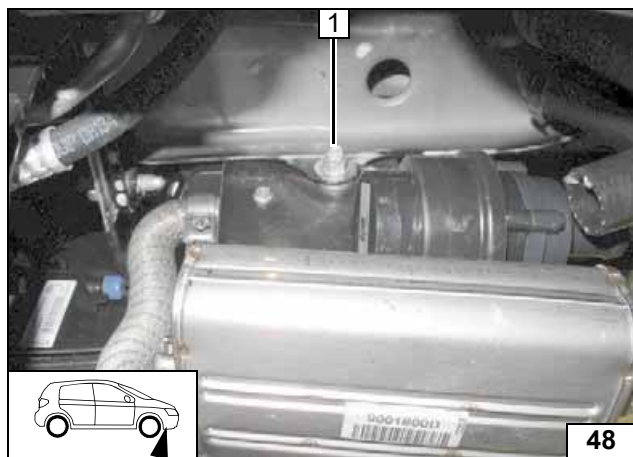
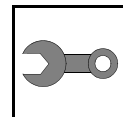

1 Stud bolt of bracket, large diameter washer, M8 flanged nut



Installing heater

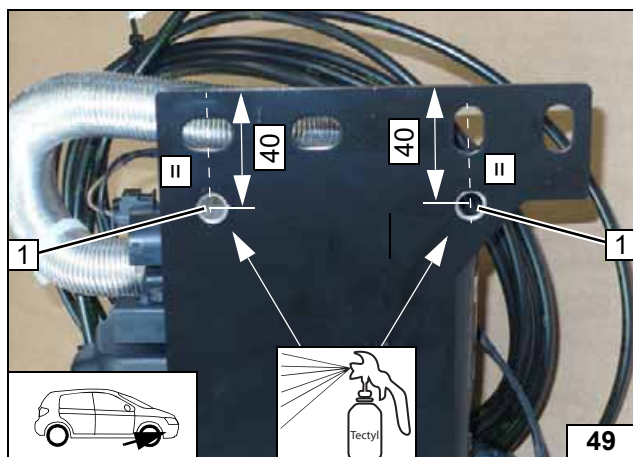

Version 2 without original vehicle stud bolt

Drill 7mm dia. hole [2x] at position 1 as shown (if not available).



Holes in heater bracket

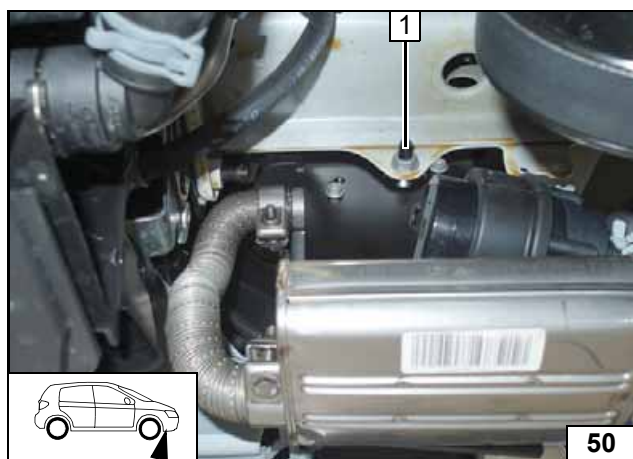

1 Mount stud bolt of bracket, large diameter washer, M8 flanged nut loosely

Loosely installing heater

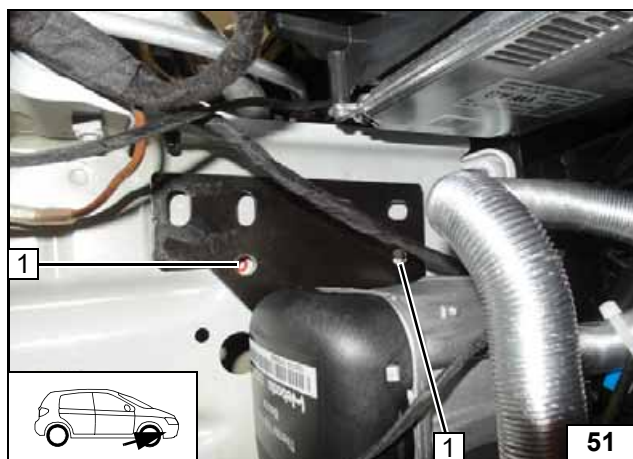

Align bracket in parallel with frame side member and copy bracket hole pattern 1 [2x].

Remove heater assembly again.



Copying hole pattern

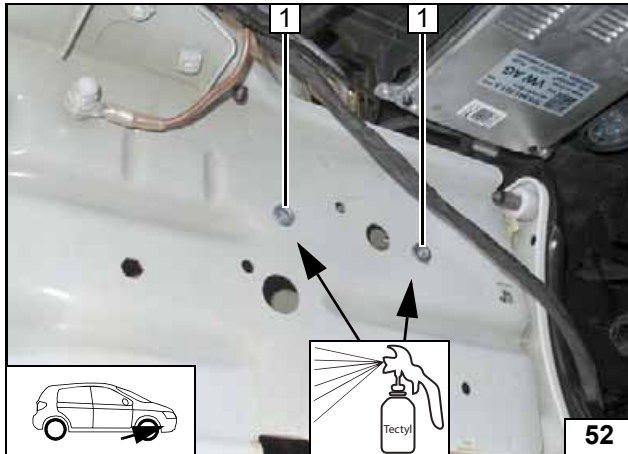
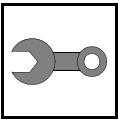

1 9mm dia. hole; rivet nut [2x]

Installing rivet nut

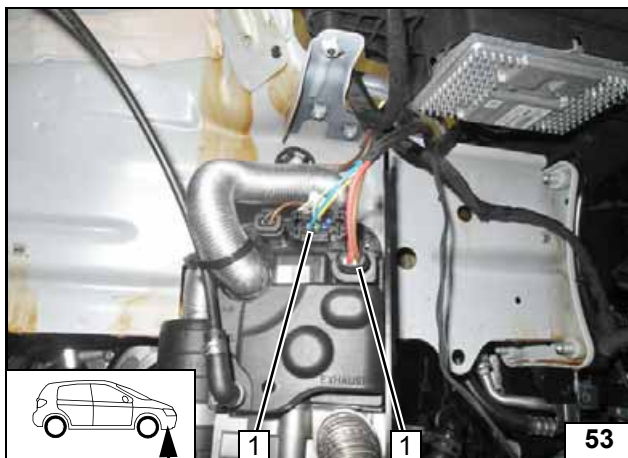

1 Heater wiring harness connector [2x]

Mounting wiring harness

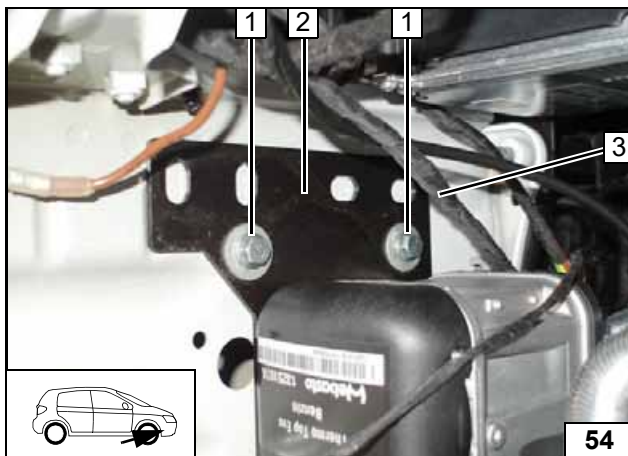

Route original vehicle wiring harness 3 in front of bracket 2 as shown.

1 M6x25 bolt, large diameter washer [2x each]

Installing heater



1 Stud bolt of bracket, large diameter washer, M8 flanged nut

Installing heater

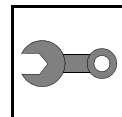

**All vehicles**

Ensure sufficient distance between exhaust pipe and horn bracket bolts, correct if necessary.

$$\left| \longleftrightarrow \right| \geq 5 \text{ mm}$$



**Aligning exhaust pipe**



Ensure sufficient distance between exhaust pipe and front fog light trim, correct if necessary.

$$\left| \longleftrightarrow \right| \geq 10 \text{ mm}$$



**Aligning exhaust pipe**

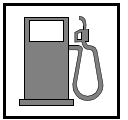

**Fuel**



Open the vehicle's fuel tank cap, ventilate the tank and then re-close the tank lock.

Catch any fuel running off in an appropriate container.



Route fuel line and metering pump wiring harness so that they are protected against stone impact. Unless specified otherwise, always fasten using cable ties.

Provide rub protection for fuel line and wiring harness in areas where there are sharp edges.

The fuel line and wiring harness are routed to the metering pump as shown in the wiring harness routing diagram.

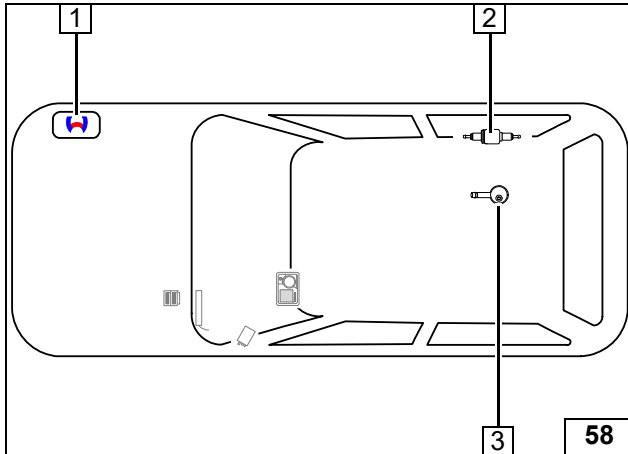

- 1 Heater assembly
- 2 Metering pump
- 3 FuelFix

58



Connector X7

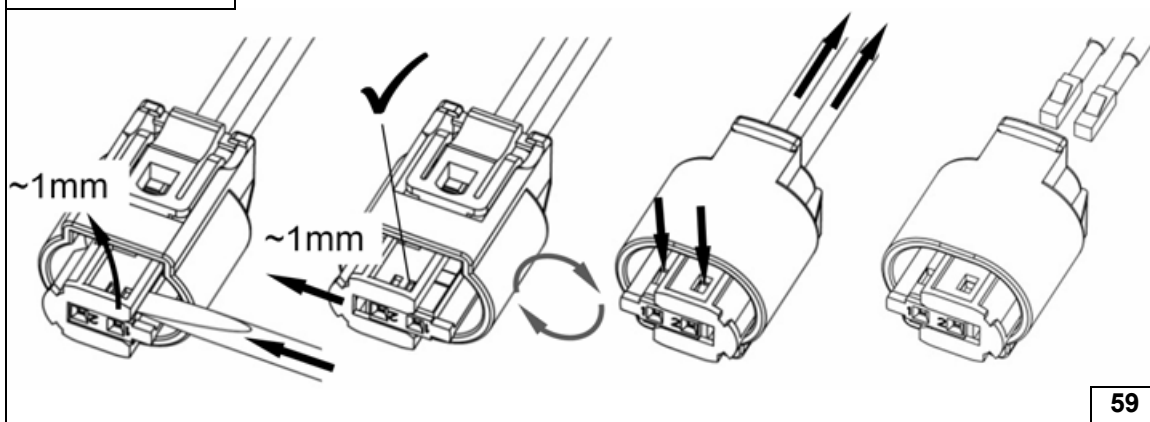

59

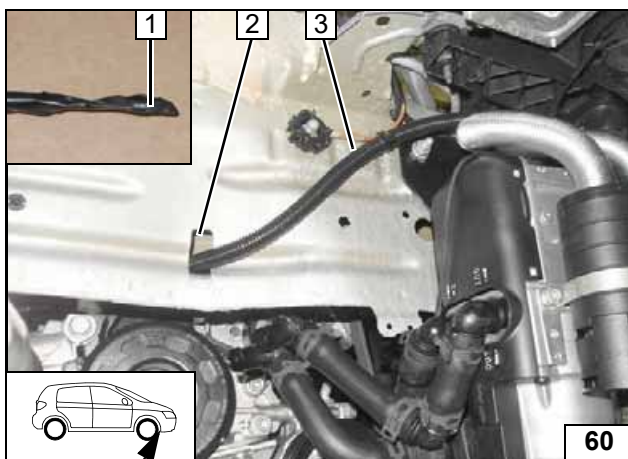

60

**Vehicles up to model year 2016**

Close the opening of the fuel line 1 with insulating tape.

Pull fuel line and metering pump wiring harness into 10 mm dia. corrugated tube 3 and route to the underbody through original vehicle pass through 2.



**Installation overview**

**Dismantling metering pump connector**



**Routing lines**

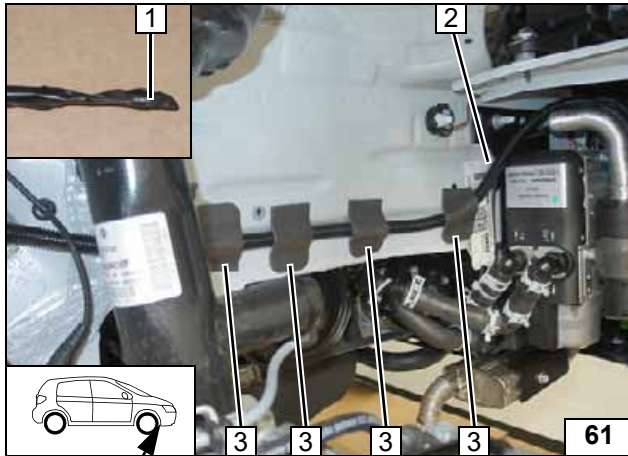
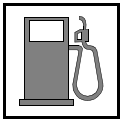

**Vehicles from model year 2017**

Close the opening of the fuel line 1 with insulating tape.  
After degreasing the bonding surfaces at position 3 [4x], draw fuel line and metering pump wiring harness into 10mm dia. (900 long) corrugated tube 2, route in wheel well as shown and fix using self-adhesive foam [4x] 3.



**Routing lines**

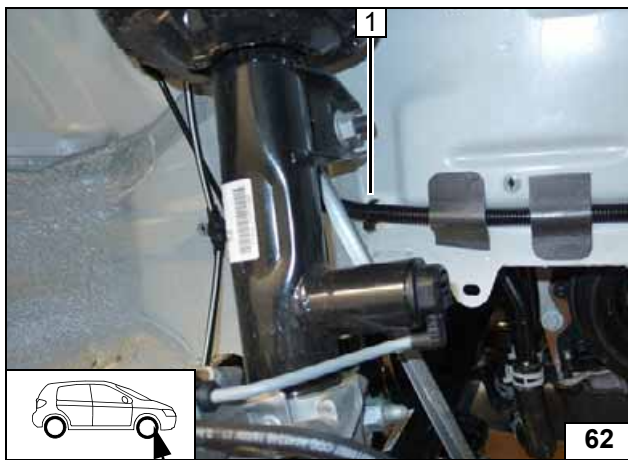

Degrease the bonding surface at position 1.

- 1 Self-adhesive socket with cable tie



**Preparing installation location of metering pump**

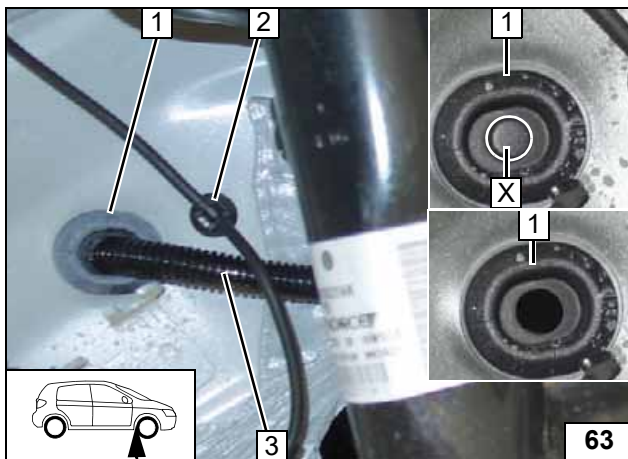

**Vehicle with clip at position 2**

Open original vehicle pass through 1 as shown, insert corrugated tube with fuel line and metering pump wiring harness 3.

X=



**Routing corrugated tube through original vehicle pass through**

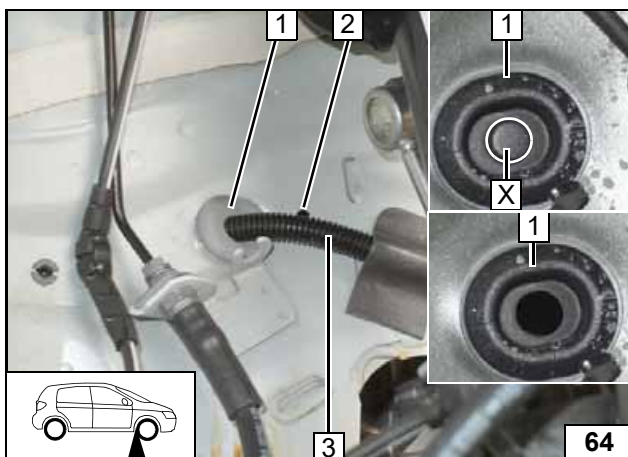

**Vehicle without clip at position 2**

Open original vehicle pass through 1 as shown, insert corrugated tube with fuel line and metering pump wiring harness 3.

X=



**Routing corrugated tube through original vehicle pass through**



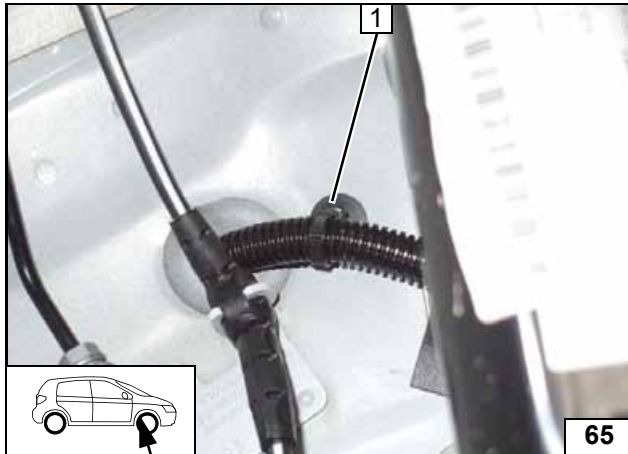
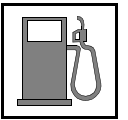

1 Original vehicle hole, eyelet cable tie

Attaching corrugated tube

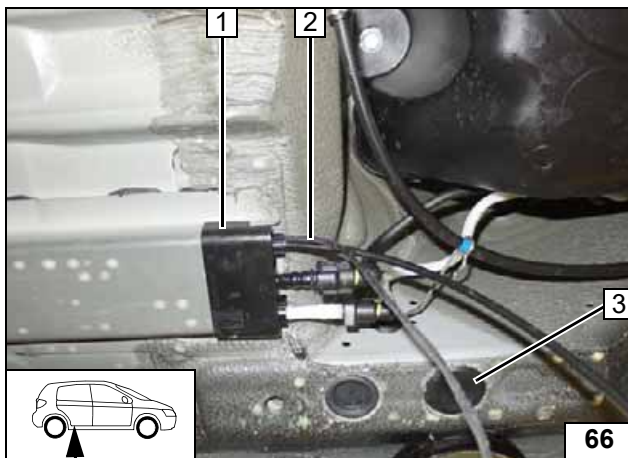

All vehicles

Version 1  
(vehicle with mechanical handbrake)

- 1 Original vehicle pass through
- 2 Fuel line and wiring harness of metering pump
- 3 Remove plug (will be needed again)

Routing lines

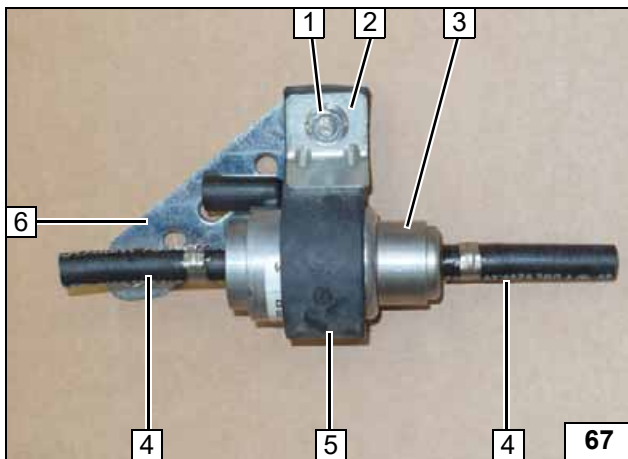

- 1 M6x25 bolt, flanged nut
- 2 Support angle bracket
- 3 Metering pump
- 4 Hose section, 10mm dia. clamp [2x each]
- 5 Metering pump mount
- 6 Perforated bracket

Pre-mounting metering pump

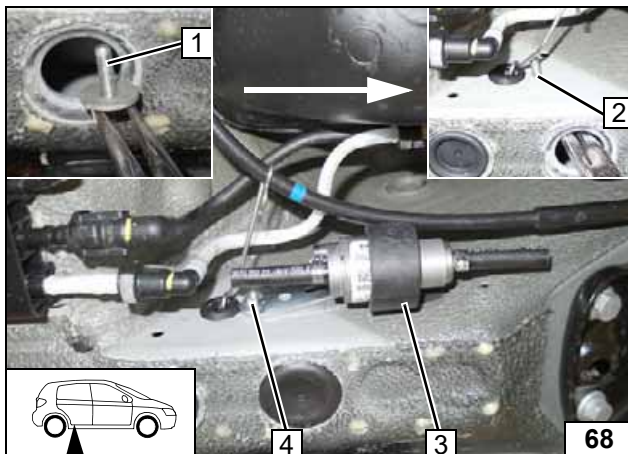

Position M6x20 bolt with large diameter washer 1 in original vehicle hole 2.

- 3 Pre-mounted metering pump
- 4 M6 flanged nut



Installing metering pump

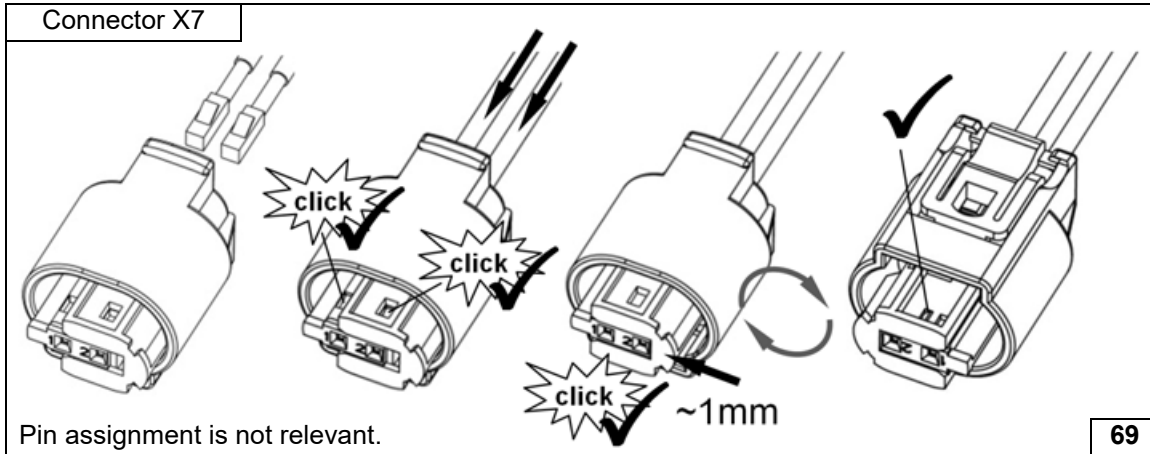

Completing metering pump connector

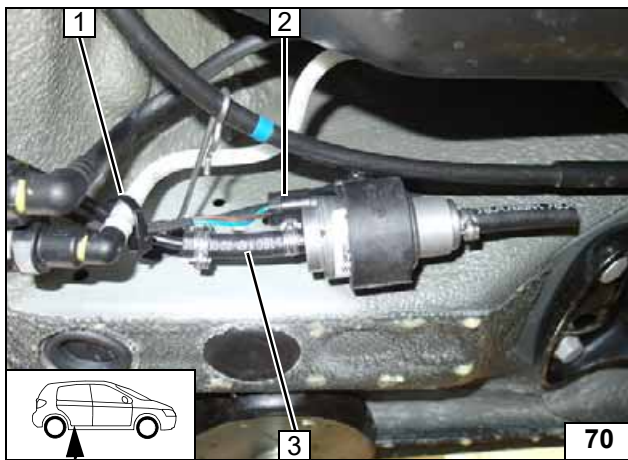

- 1 Cable tie
- 2 Metering pump wiring harness, connector X7 mounted
- 3 Fuel line of heater, hose section, 10 mm dia. clamp [2x]



Connecting metering pump

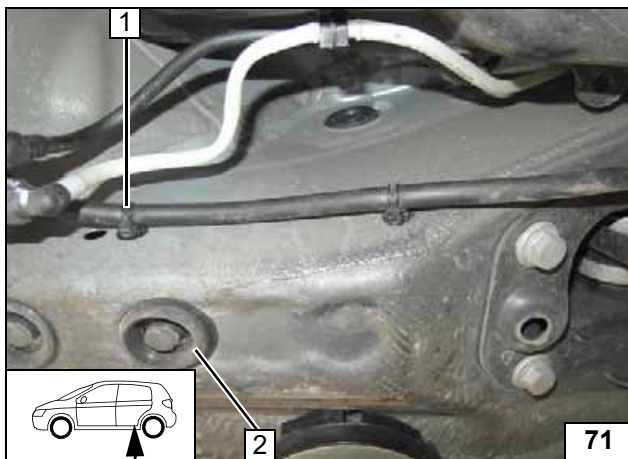

**Version 2**  
(vehicle with electrical handbrake)

- 1 Remove retaining clip from hole (if present)
- 2 Remove cover cap (will be re-inserted later)



Preparing installation location of metering pump

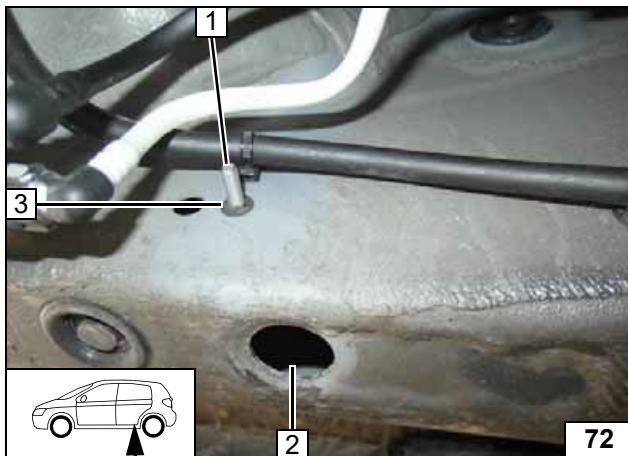

Insert M6x20 bolt 1 through opening 2 into hole.

- 3 Lock washer



Preparing installation location of metering pump

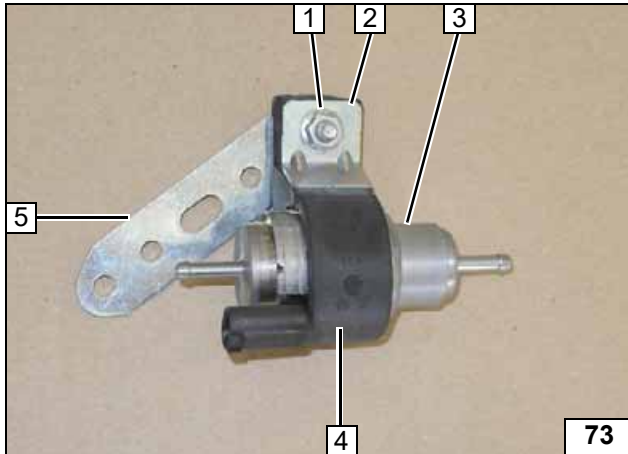
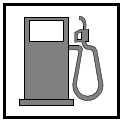

- 1 M6x25 bolt, flanged nut
- 2 Support angle bracket
- 3 Metering pump
- 4 Metering pump mount
- 5 Perforated bracket

**Premounting metering pump**

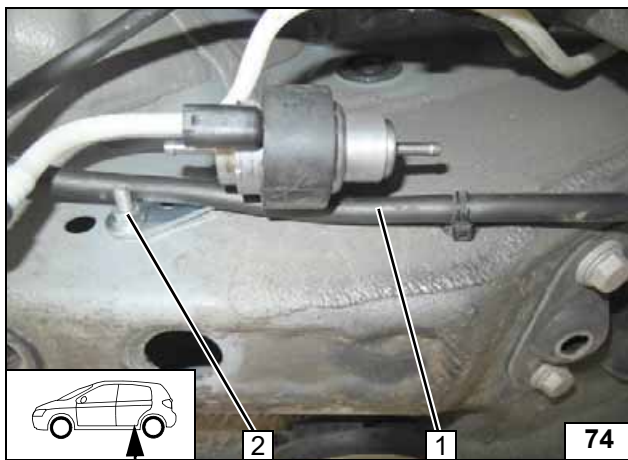

Route original vehicle wiring harness 1 as shown.

- 2 M6 flanged nut



**Installing metering pump**

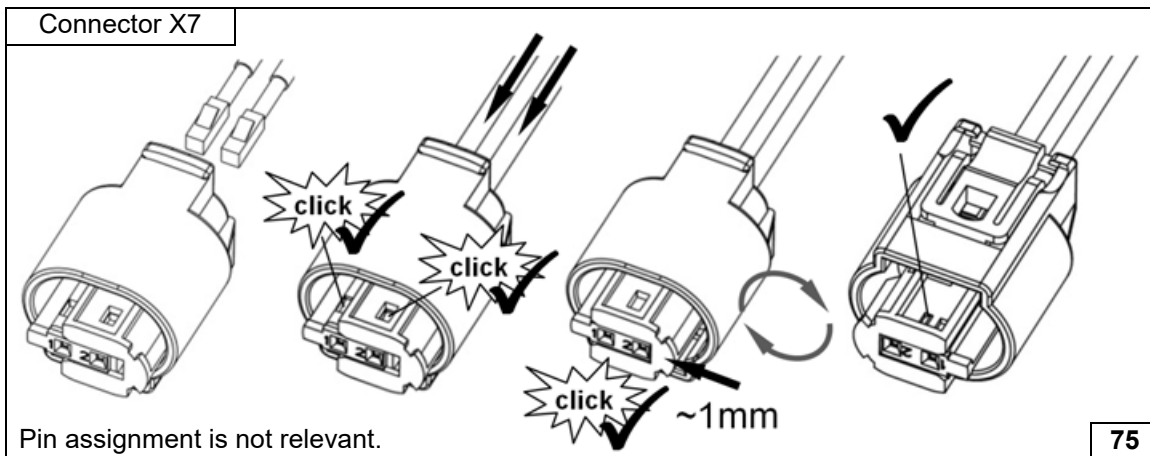

Pin assignment is not relevant.

**Completing metering pump connector**

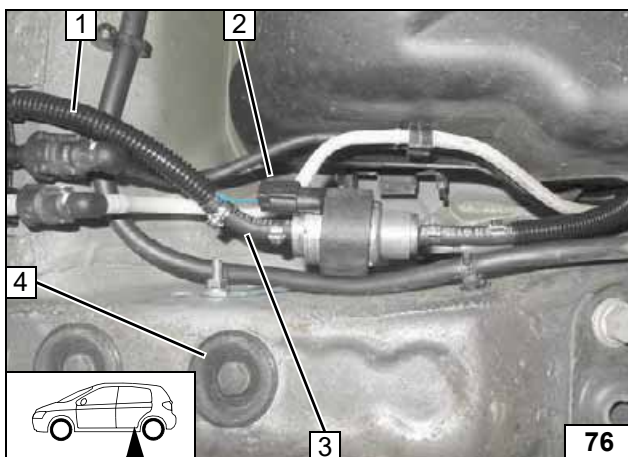

Cut off 130mm of 10mm dia. corrugated tube. Insert fuel line and metering pump wiring harness into 130mm corrugated tube 1.

- 2 Metering pump wiring harness, connector X7 mounted
- 3 Fuel line of heater, hose section, 10 mm dia. clamp [2x]
- 4 Cover cap inserted



**Connecting metering pump**

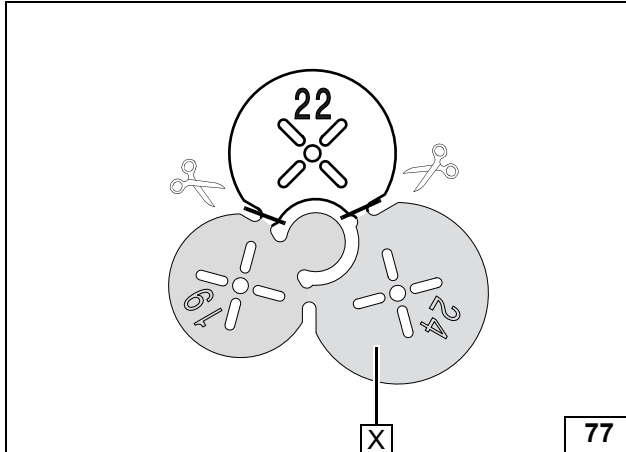
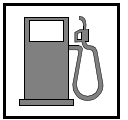

**FuelFix Installation for TSI**

x =

**Preparing drilling template**

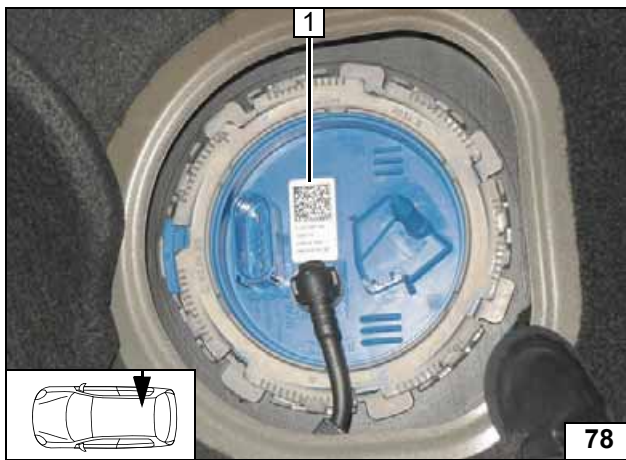

Work step F1.

Remove sticker 1, will be put back in a new position later.



**Moving sticker**

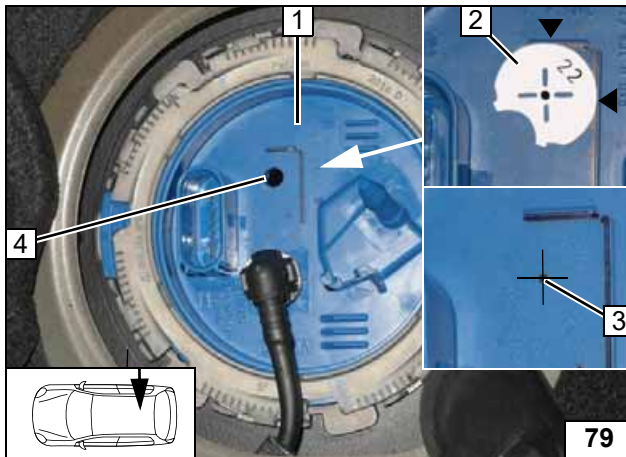

Work steps F2 and F3.

- 1 Fuel tank sending unit
- 2 Position template with outer dia.  $d_a = 22$  mm against the marking
- 3 Hole pattern
- 4 Hole made with provided drill

**Copying hole pattern, drilling hole**

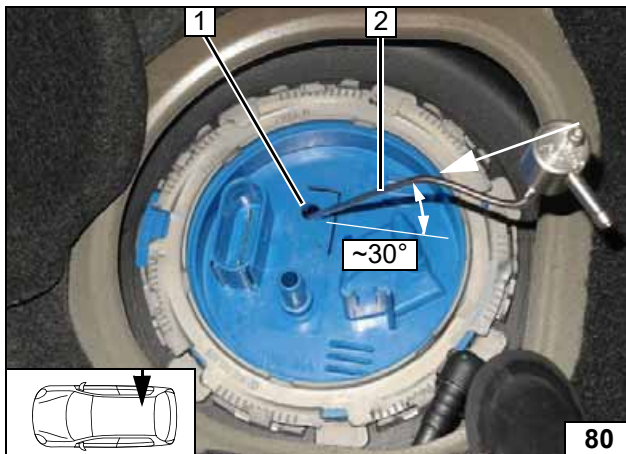

Work steps F4 and F5.

Bend FuelFix 2 according to template and cut to length. Insert into hole 1.



**Inserting FuelFix**

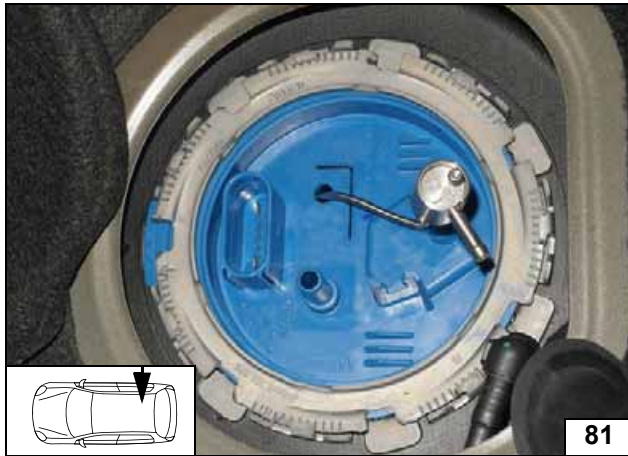
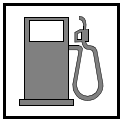

Work step F5.

Inserting FuelFix

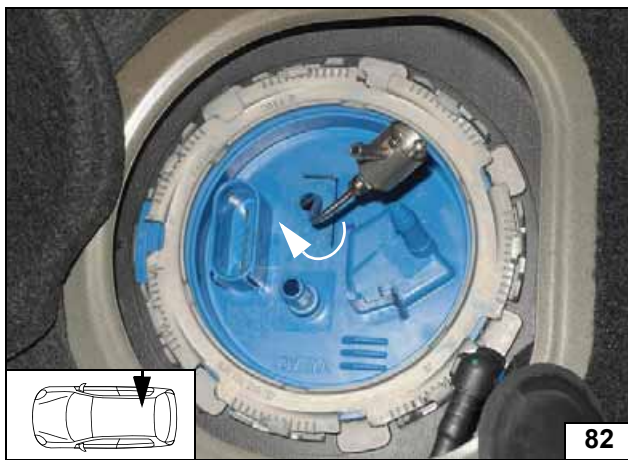

Inserting FuelFix

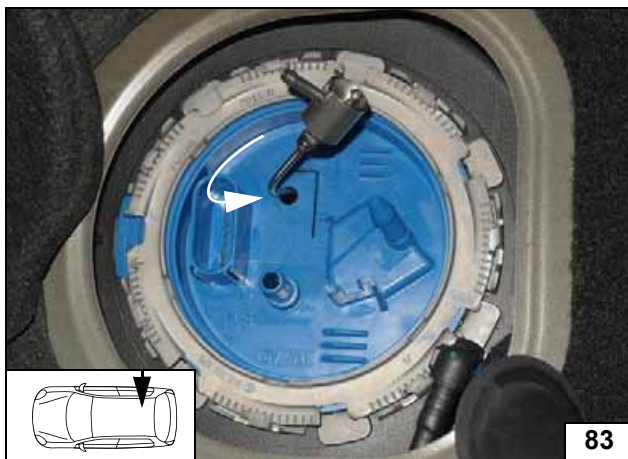

Inserting FuelFix

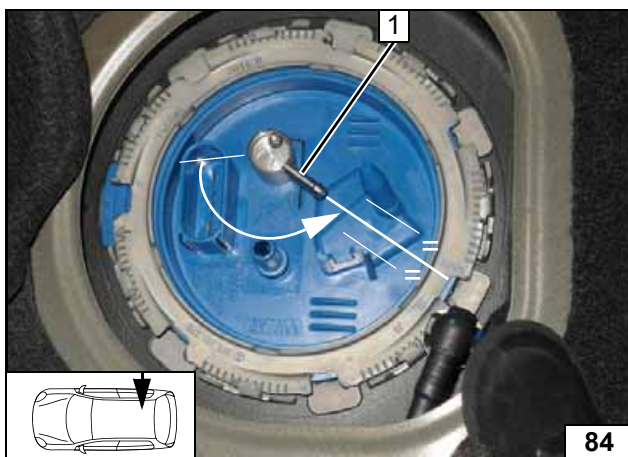

Work steps F5.3 and F5.4.

Align FuelFix 1 as shown.



Inserting FuelFix

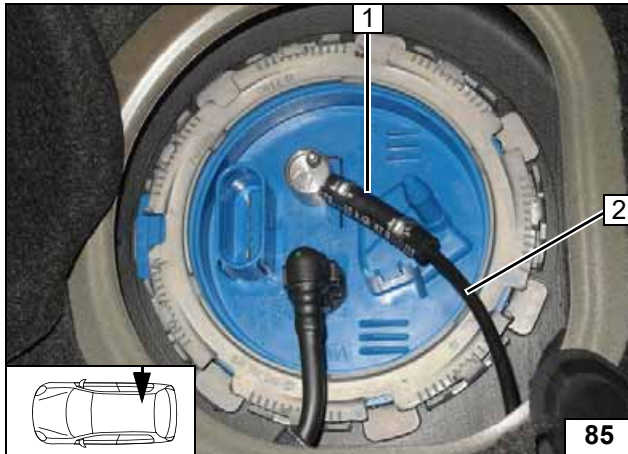
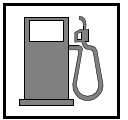

Work step F6.

- 1 Hose section, 10mm dia. clamp [2x]
- 2 Fuel line

Connect-  
ing fuel line

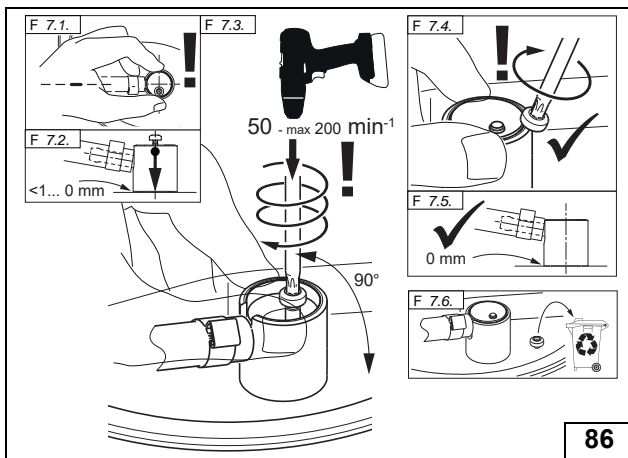

Work step F7.



Mounting  
FuelFix



Work step F8.

Ensuring  
firm seating  
of FuelFix



Fix fuel line 1 at an appropriate place using a cable tie to provide tension relief.

- 2 Move sticker



Securing  
fuel line

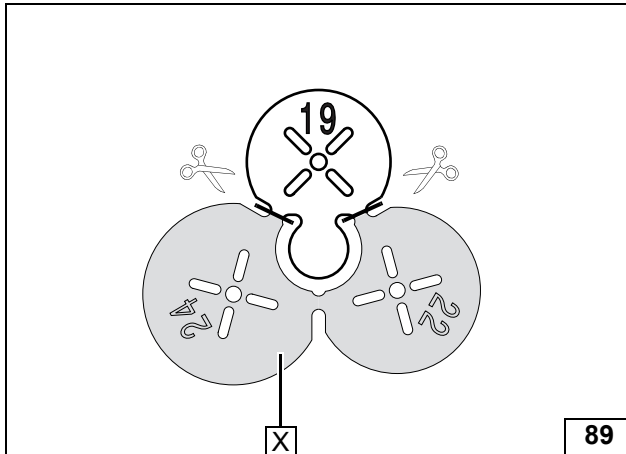
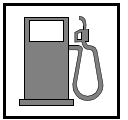

**FuelFix Installation for TDI**

X=

**Preparing drilling template**

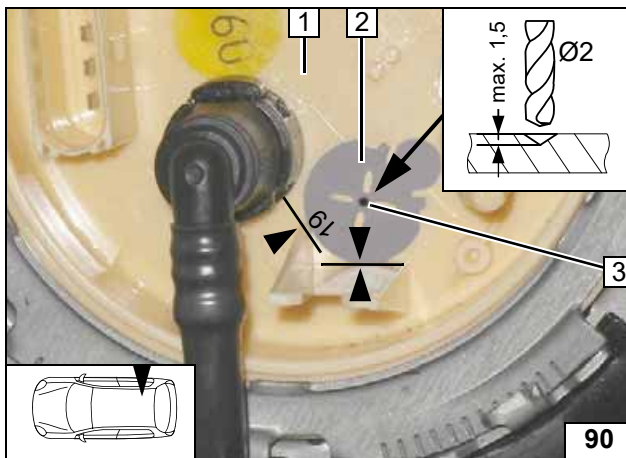

Work steps F1 and F2.

- 1 Fuel tank sending unit
- 2 Position 19mm dia. drilling template as shown
- 3 2mm dia. centring hole



**Copying hole pattern**

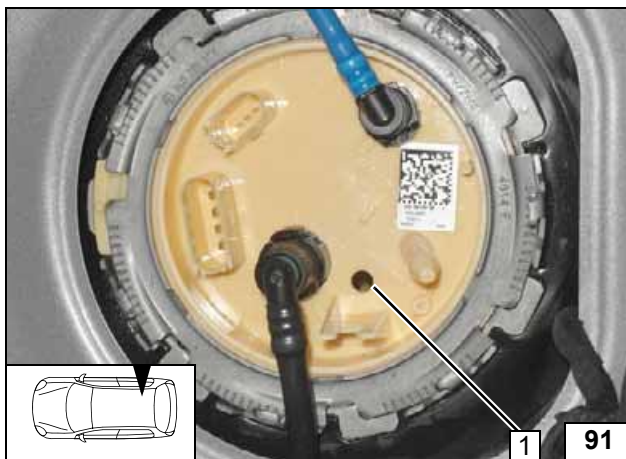

Work step F3.

- 1 Hole made with provided drill

**Hole for FuelFix**

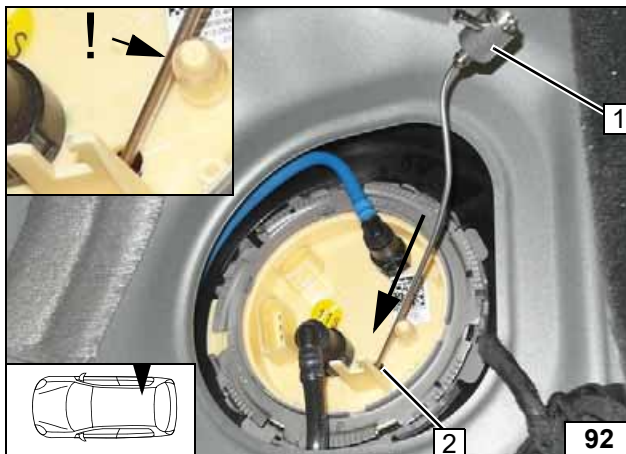

Work steps F4 and F5.

Bend FuelFix 1 according to template and cut to length. Insert into hole 2.



**Inserting FuelFix**

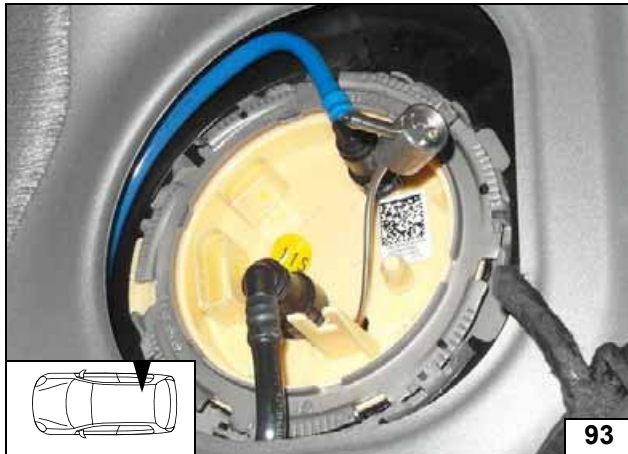
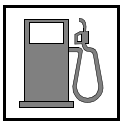

Work step F5.

Inserting  
FuelFix

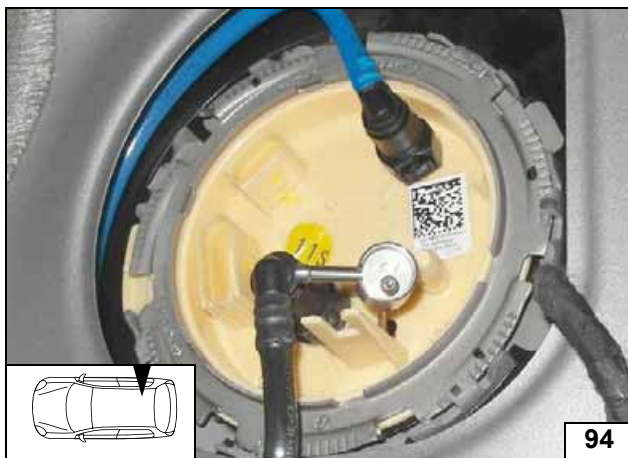

Inserting  
FuelFix

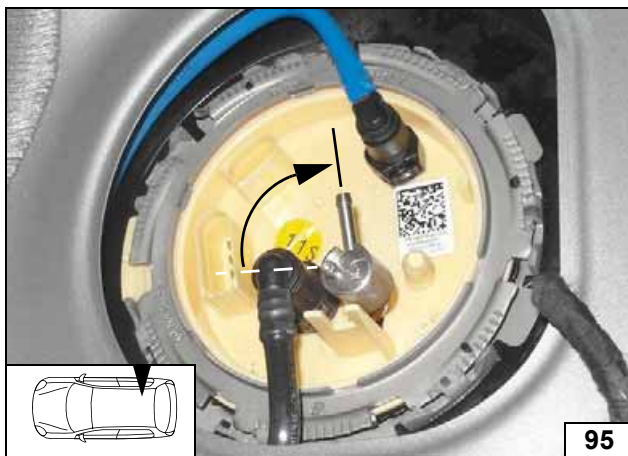

Inserting  
FuelFix

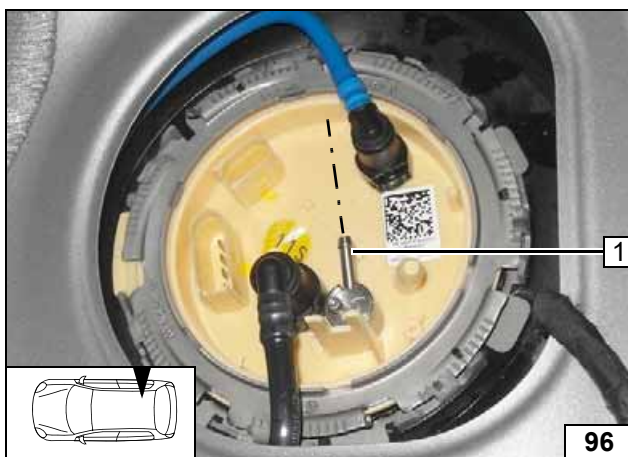

Work steps F5.3 and F5.4.

Align FuelFix 1 as shown.



Aligning  
FuelFix



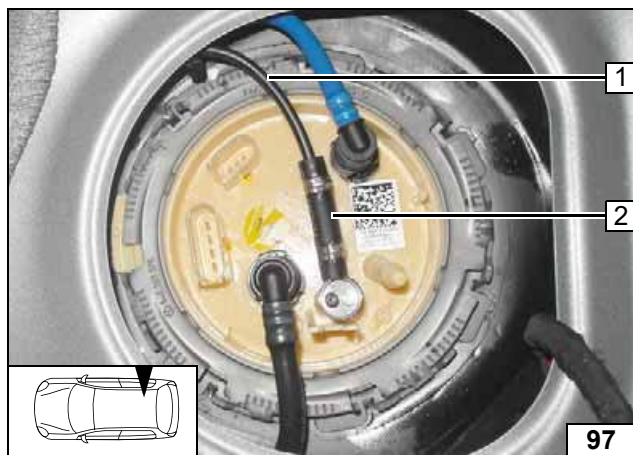

Work step F6.

- 1 Fuel line
- 2 Hose section, 10mm dia. clamp [2x]

Connect-  
ing fuel line

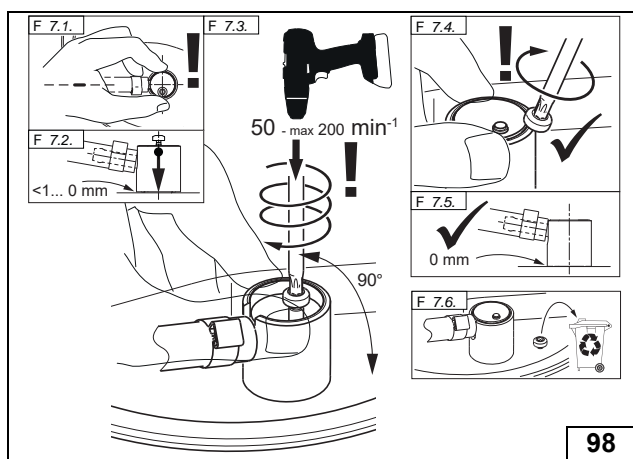

Work step F7.



Mounting  
FuelFix

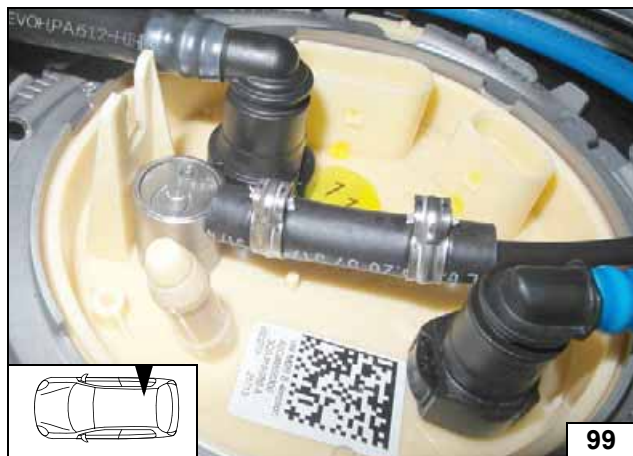

Work step F8.

Ensuring  
firm seating  
of FuelFix

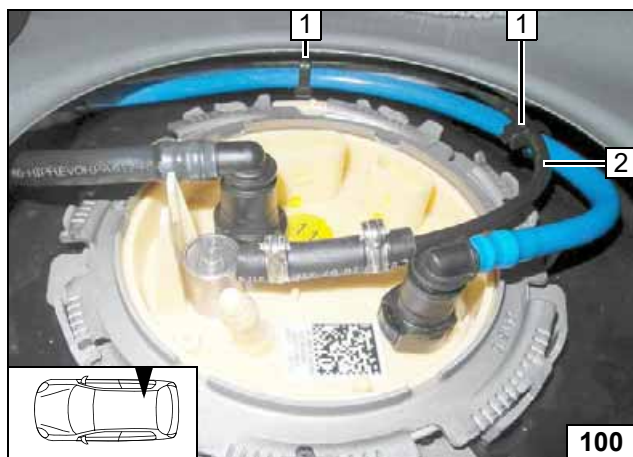

- 1 Cable tie as tension relief [2x]
- 2 Fuel line

Securing fuel  
line

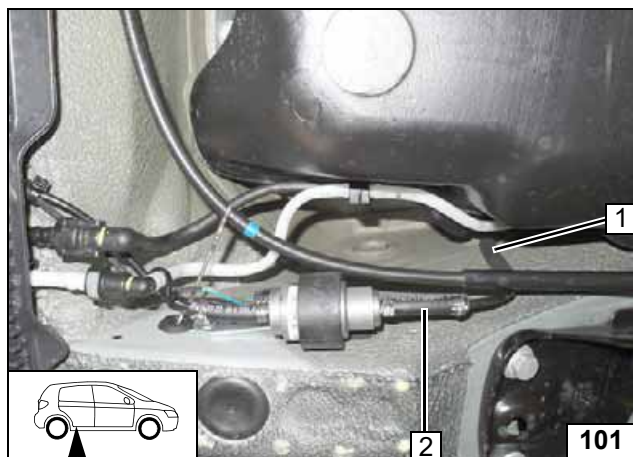

Slide 10 mm dia. corrugated tube **1** onto fuel line. Check the position of the components; adjust if necessary. Check that they have freedom of movement.



- 2** Fuel line of FuelFix, hose section, 10mm dia. clamp [2x]

**Connect-  
ing meter-  
ing pump**

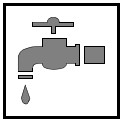

### Coolant Circuit of TSI







Any coolant running off should be collected in an appropriate container. Route hoses kink-free. Unless specified otherwise, always fasten using cable ties. Position clamps so that other hoses cannot be damaged. The heater must be filled with coolant when installing the hoses.

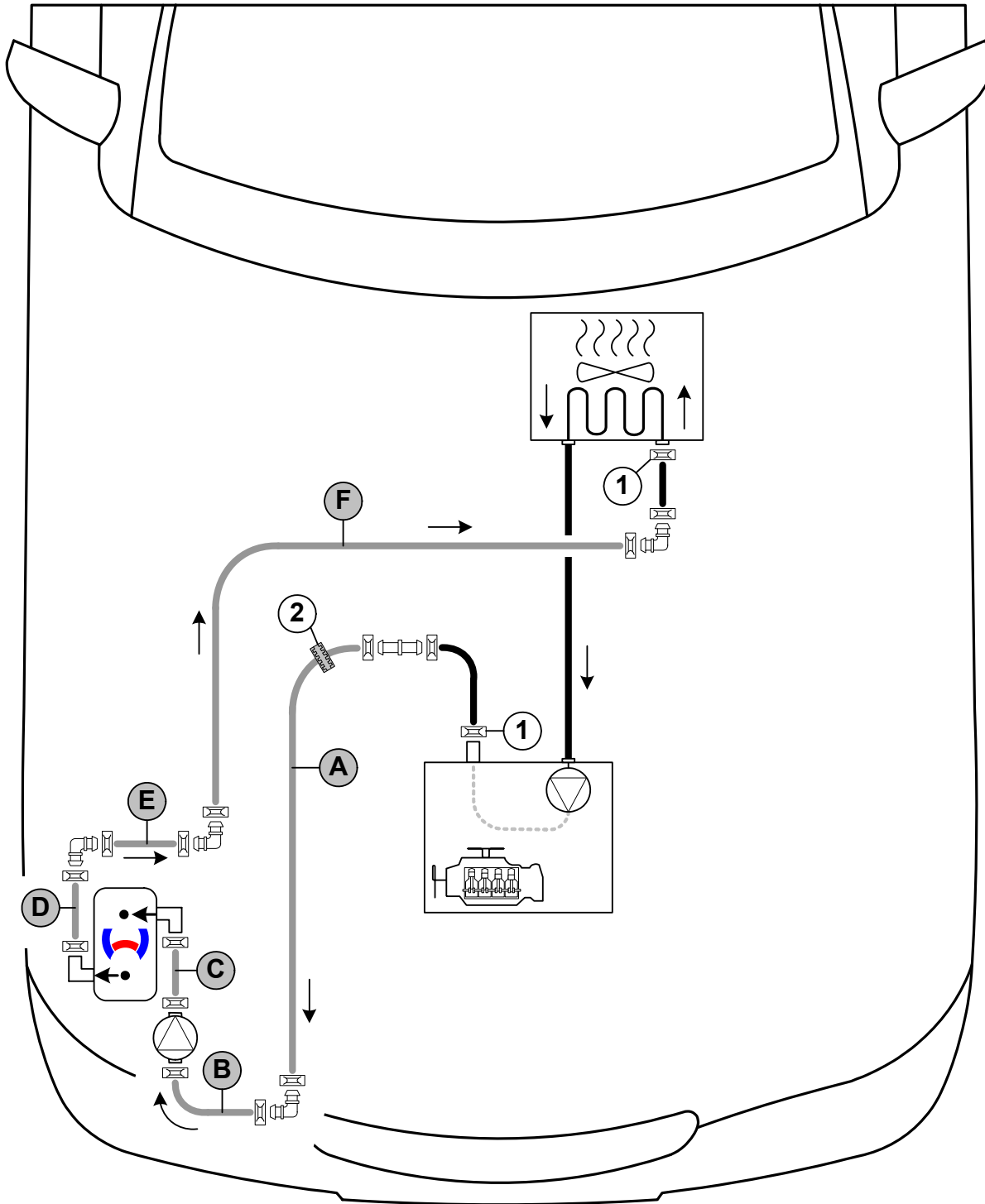

The connection should be modelled on an 'inline' circuit and based on the following diagram:



Hose routing diagram

All spring clips without a specific designation  = 25 mm dia. All connecting pipes  and  = 18x18 mm dia. 1 = Original vehicle spring clip . 2 = Black (sw) rubber isolator 



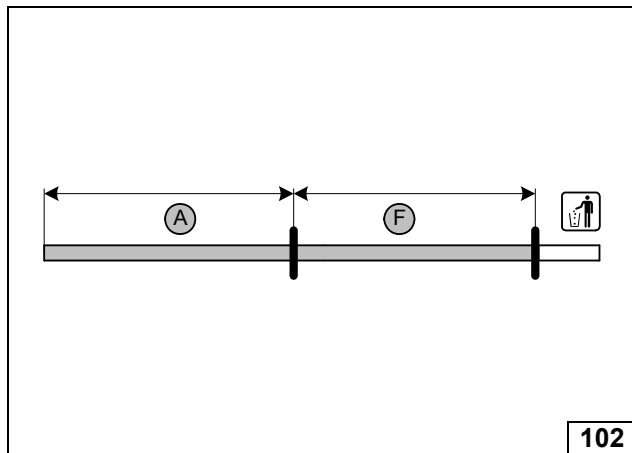
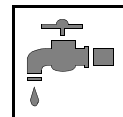

	1.0, 1.2 and 1.4 Petrol	1.8 Petrol
<b>A</b>	1070	1000
<b>F</b>	990	990

**Cutting hoses to length**

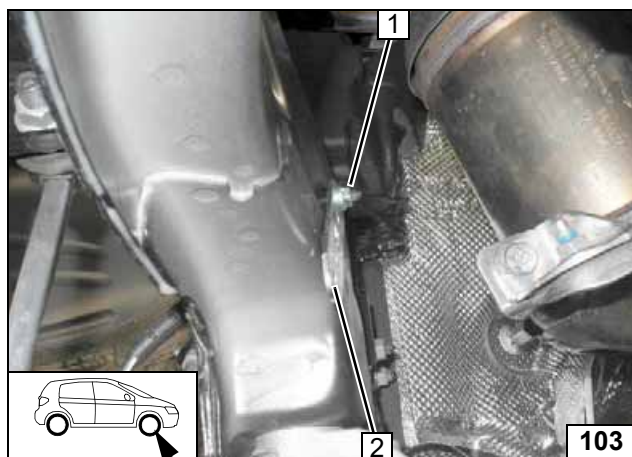

- 1 M6 flanged nut, original vehicle stud bolt
- 2 Perforated bracket

**Installing perforated bracket**

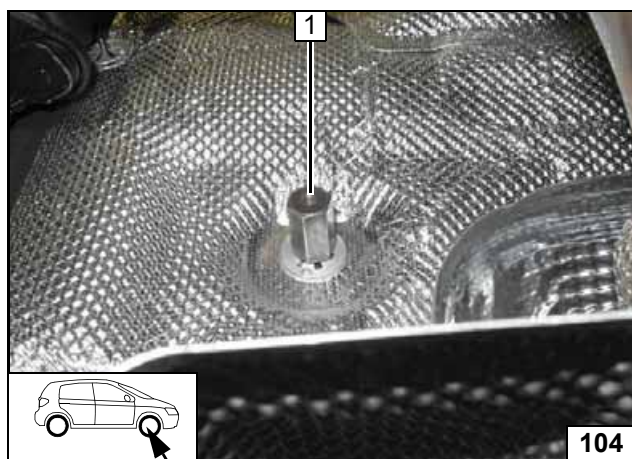

- 1 M6x30 spacer nut, original vehicle stud bolt

**Installing spacer nut**

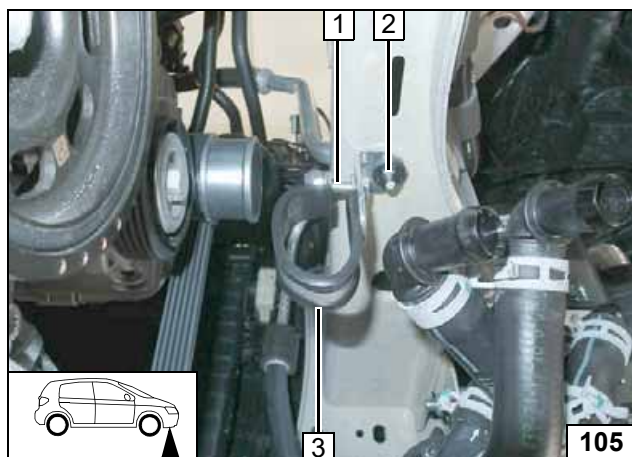

- 1 Install M6x20 bolt loosely
- 2 Original vehicle stud bolt, angle bracket, plastic nut
- 3 38 mm dia. rubber-coated p-clamp

**Installing rubber-coated p-clamp**

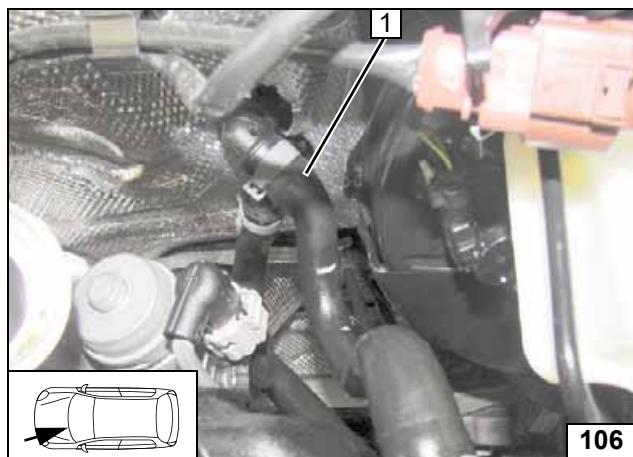
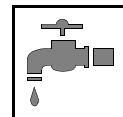

Except for 1.8 petrol vehicles

Remove engine outlet / heat exchanger inlet hose 1. Spring clips will be reused!

Cutting point

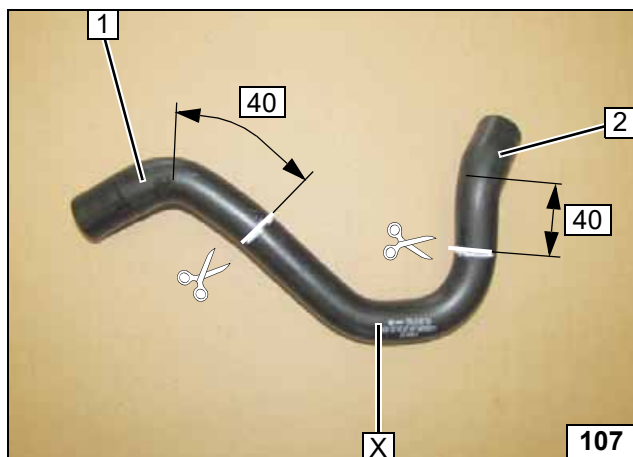

Version 1

- 1 Engine outlet hose section
- 2 Heat exchanger inlet hose section

X =

Preparing engine outlet / heat exchanger inlet hose

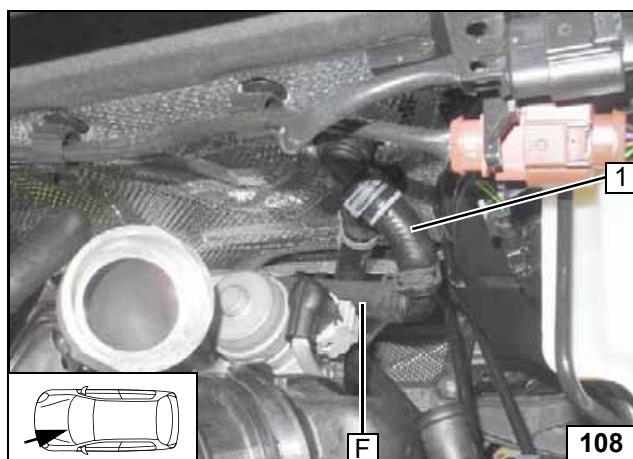

- 1 Heat exchanger inlet hose section

Connecting heat exchanger inlet

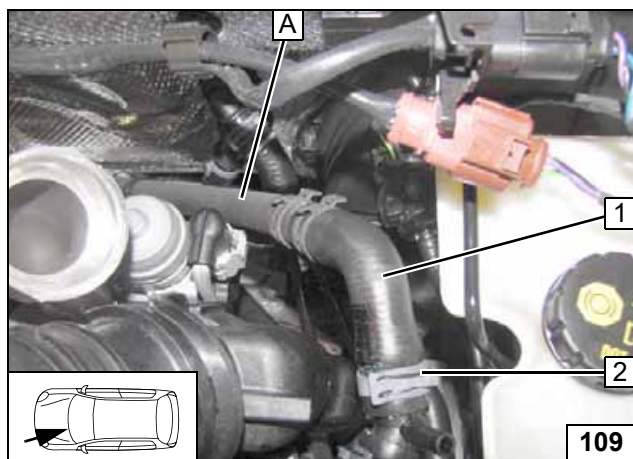

- 1 Engine outlet hose section
- 2 Original vehicle spring clip

Connecting engine outlet

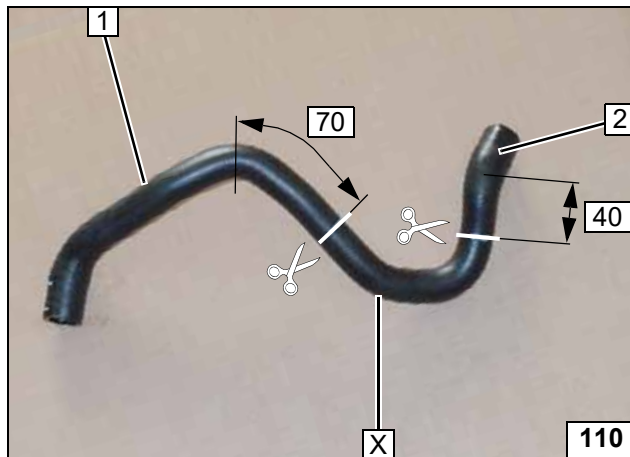

**Version 2**

- 1 Engine outlet hose section
- 2 Heat exchanger inlet hose section

X =

**Preparing engine outlet / heat exchanger inlet hose**

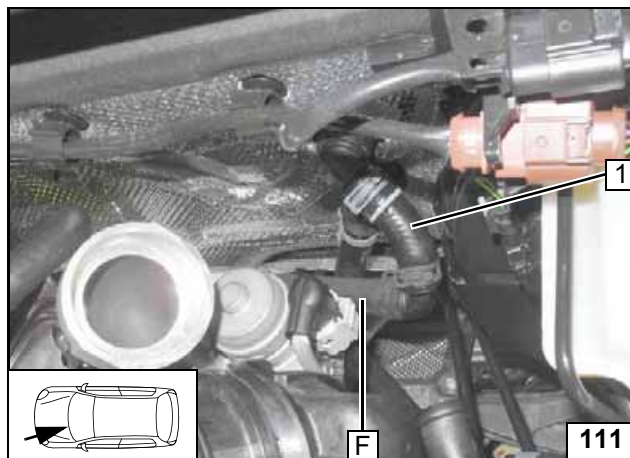

- 1 Heat exchanger inlet hose section

**Connecting heat exchanger inlet**

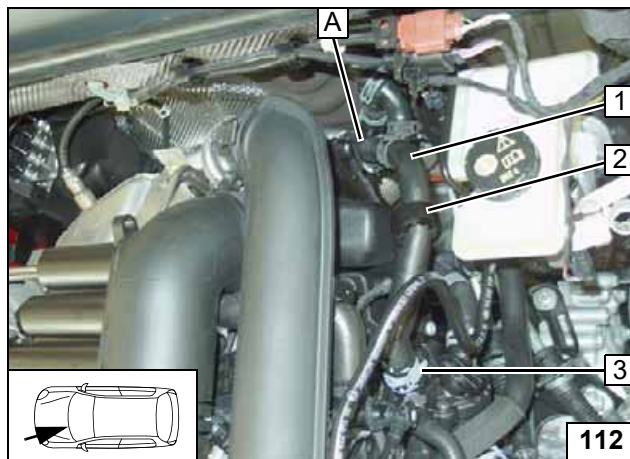

- 1 Engine outlet hose section
- 2 Black (sw) rubber isolator
- 3 Original vehicle spring clip

**Connecting engine outlet**

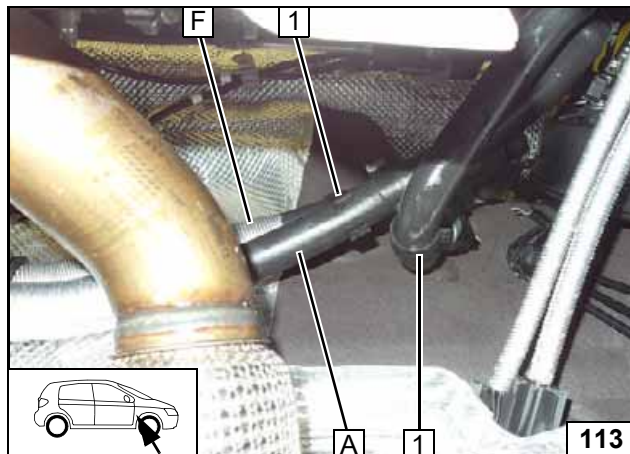

Push one 600 mm long heat protection hose each onto hoses **A** and **F**.

- 1 Rotatable spacer bracket [2x]



**Routing on firewall**

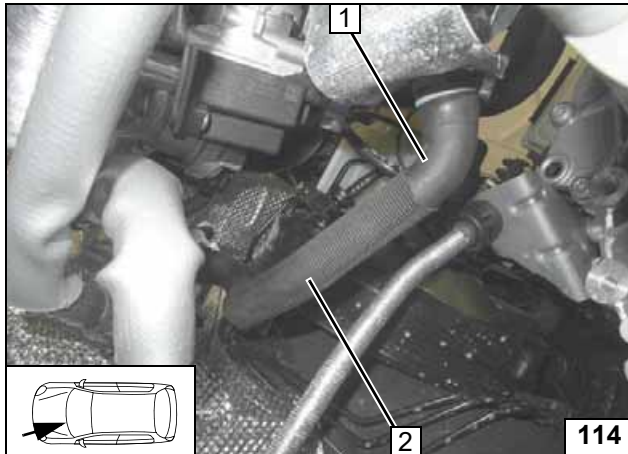
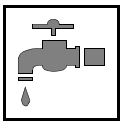

**1.8 Petrol**

Remove engine outlet / heat exchanger inlet hose 1. Spring clips will be reused. Remove rub protection 2.



**Cutting point**

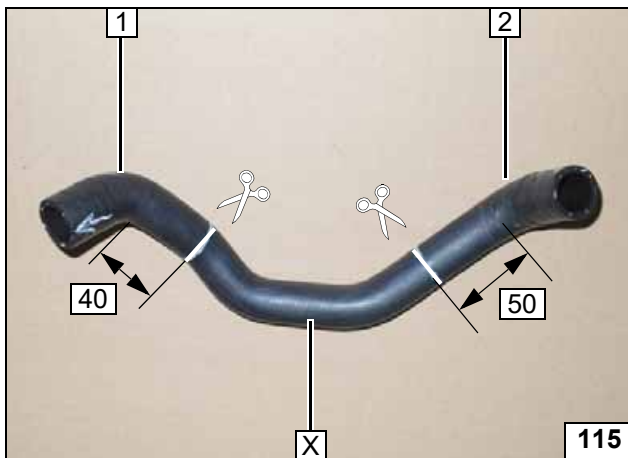

- 1 Heat exchanger inlet hose section
- 2 Engine outlet hose section

x =

**Preparing engine outlet / heat exchanger inlet hose**

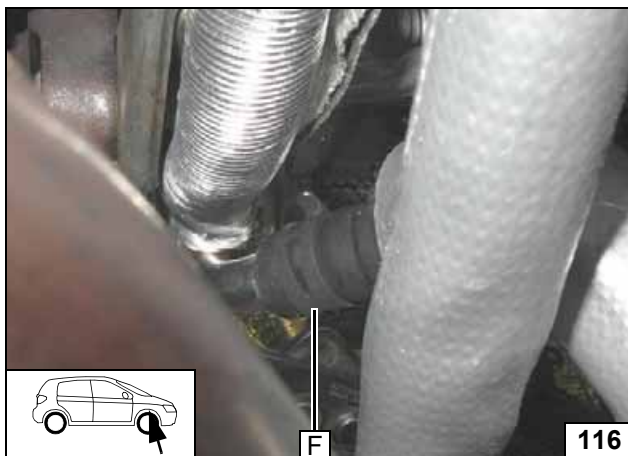

Turn upper spring clip of Turbo / Y piece of heat exchanger outlet by 180° (for final position see figure).



**Connecting heat exchanger inlet**

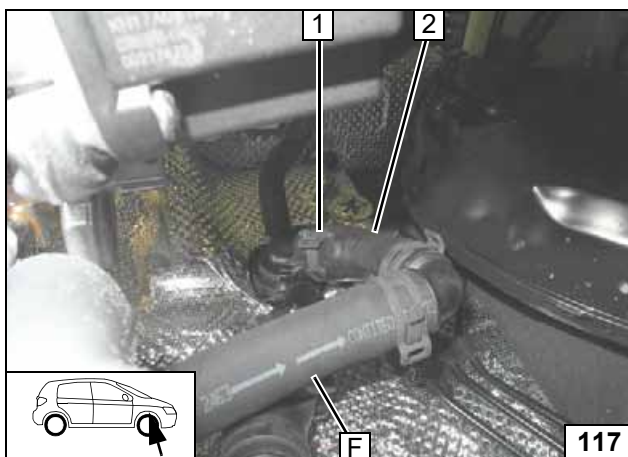

- 1 Original vehicle spring clip
- 2 Heat exchanger inlet hose section

**Connecting heat exchanger inlet**

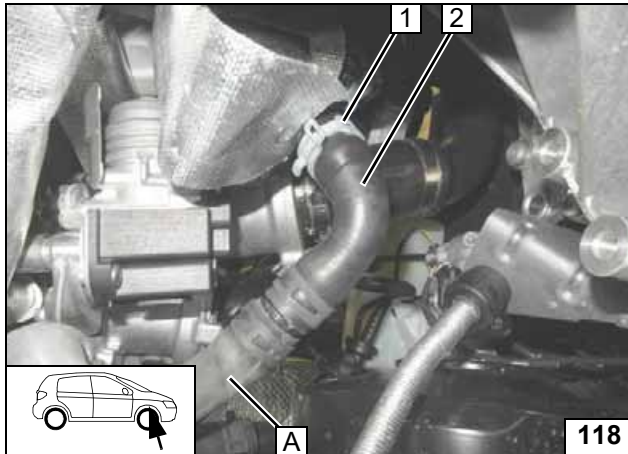
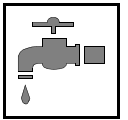

- 1 Original vehicle spring clip
- 2 Engine outlet hose section

Connect-  
ing engine  
outlet

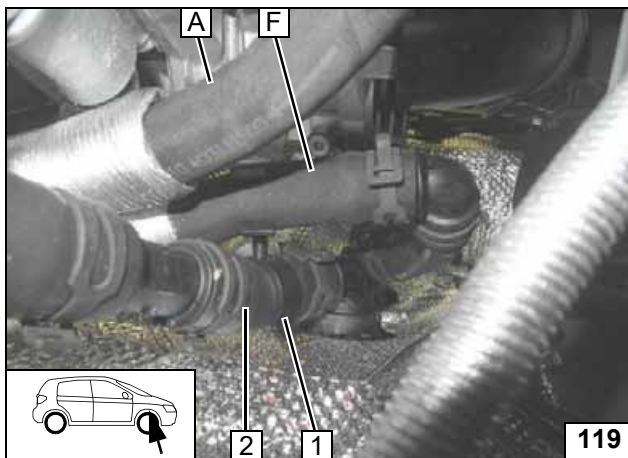

Push one 600 mm long heat protection hose each onto hoses **A** and **F**.

- 1 Twistable spacer bracket
- 2 Hose of heat exchanger outlet

Routing on  
firewall

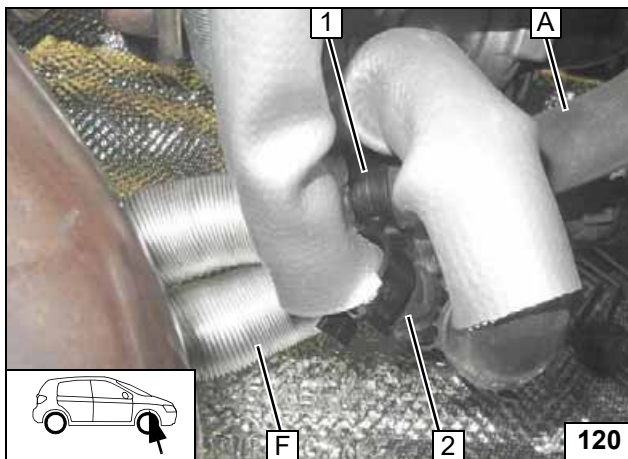

Align hoses **A** and **F** and Ensure sufficient distance from exhaust tube!

- 1 Twistable spacer bracket
- 2 Original vehicle hose



Routing on  
firewall

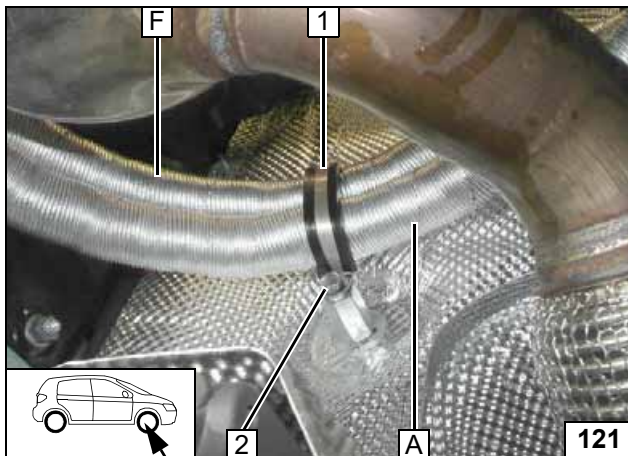

**All petrol vehicles**

- 1 48 mm dia. rubber-coated p-clamp
- 2 M6x20 bolt, spring lockwasher

Fastening on  
firewall



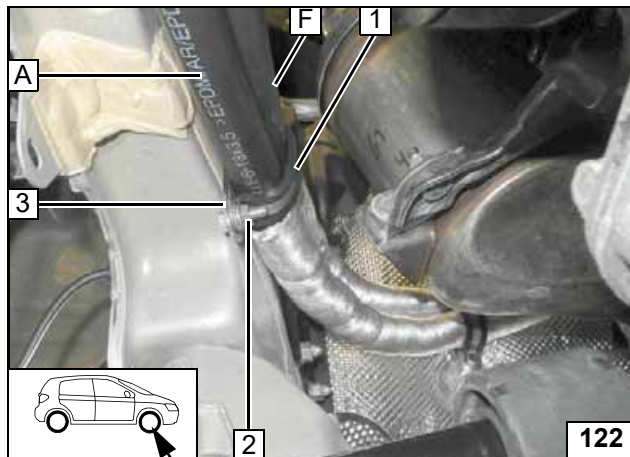

Align hoses.  
Ensure sufficient distance from catalytic converter; correct if necessary.



- 1 38 mm dia. rubber-coated p-clamp
- 2 M6x20 bolt, flanged nut
- 3 Perforated bracket

**Routing on frame side member**

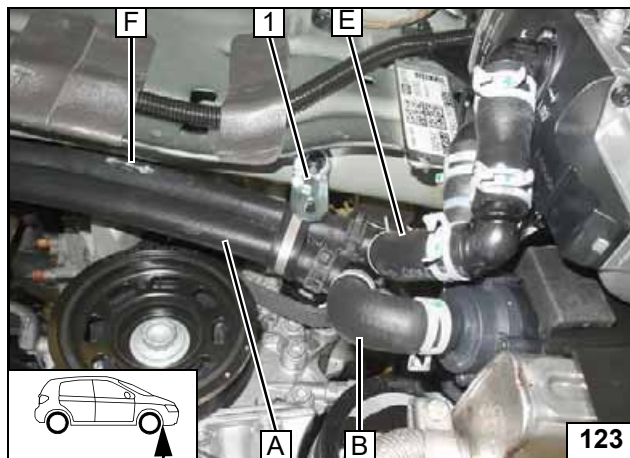

- 1 Tighten bolt

**Connecting heater**

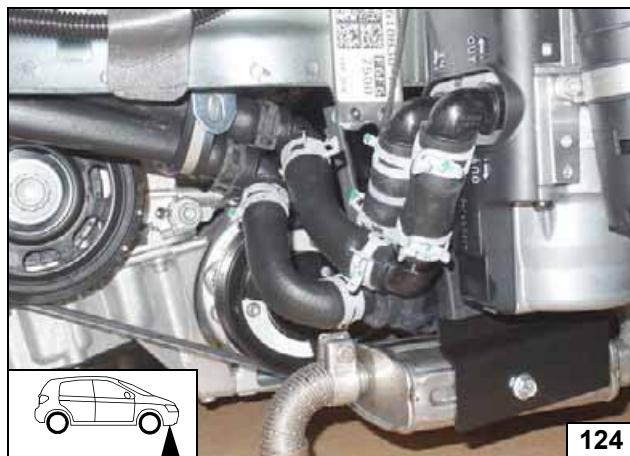

Align hoses and spring clips as shown.  
Ensure sufficient distance from neighbouring components, correct if necessary.



**Aligning hoses and spring clips**

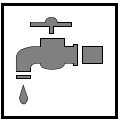

### Coolant Circuit of TDI 2WD



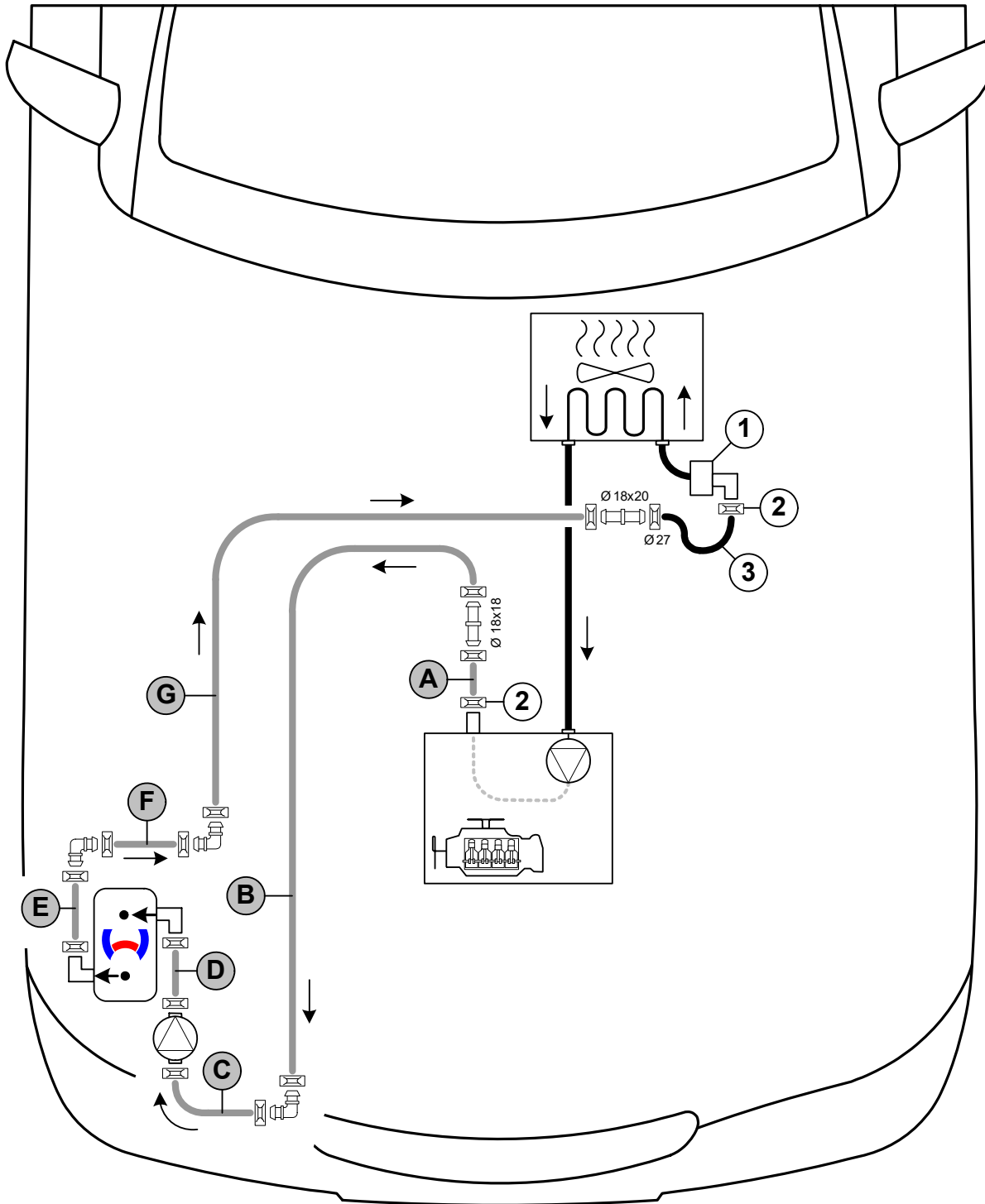

Any coolant running off should be collected in an appropriate container. Route hoses kink-free. Unless specified otherwise, always fasten using cable ties. Position clamps so that other hoses cannot be damaged. The heater must be filled with coolant when installing the hoses.

The connection should be modelled on an 'inline' circuit and based on the following diagram:



Hose routing diagram

All spring clips without a specific designation  = 25 mm dia. All connecting pipes  = 18x18 mm dia.

1 = EGR

2 = Original vehicle spring clip .

3 = Original vehicle hose



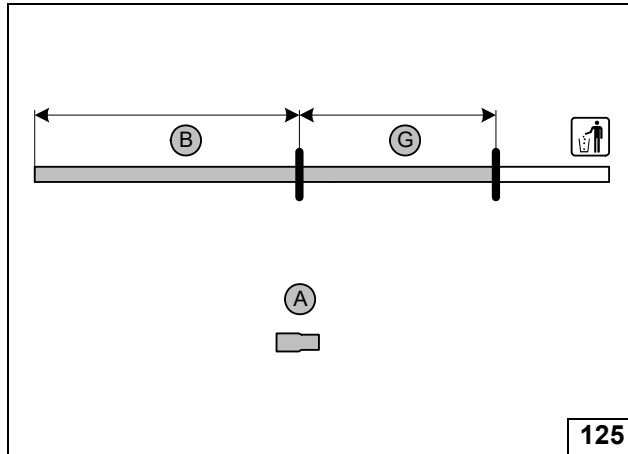

- A = 18x20mm dia.
- B = 1020
- G = 980

Cutting hoses to length

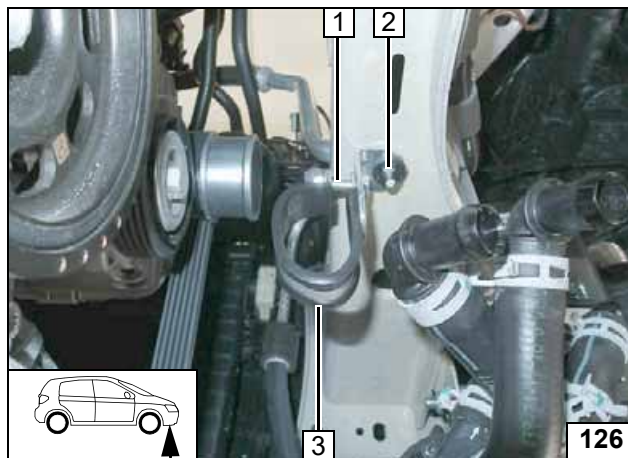

- 1 Install M6x20 bolt loosely
- 2 Original vehicle stud bolt, angle bracket, plastic nut
- 3 38 mm dia. rubber-coated p-clamp

Installing rubber-coated p-clamp

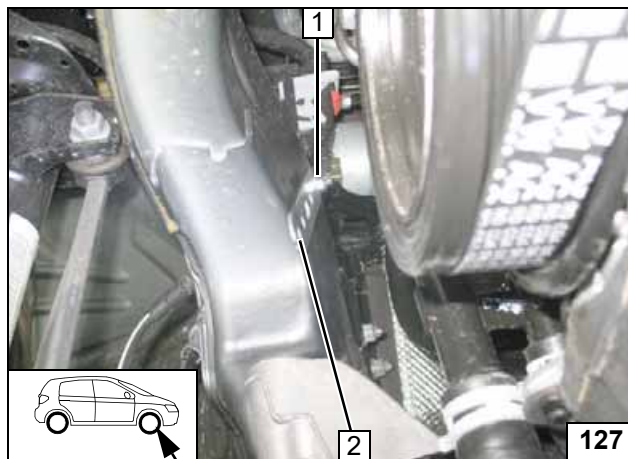

- 1 M6 flanged nut, original vehicle stud bolt
- 2 Perforated bracket

Installing perforated bracket

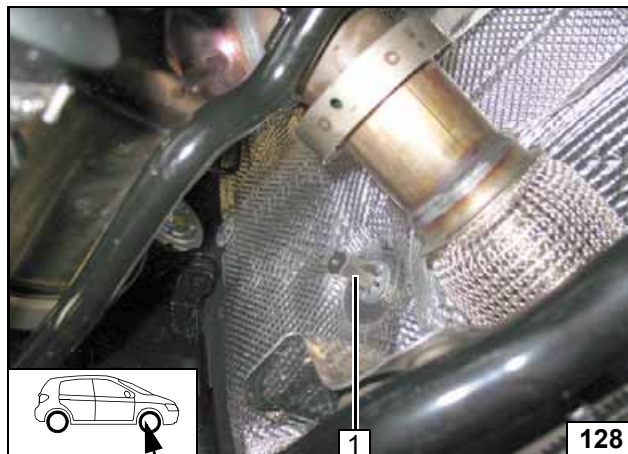

- 1 M6x30 spacer nut, original vehicle stud bolt

Installing spacer nut

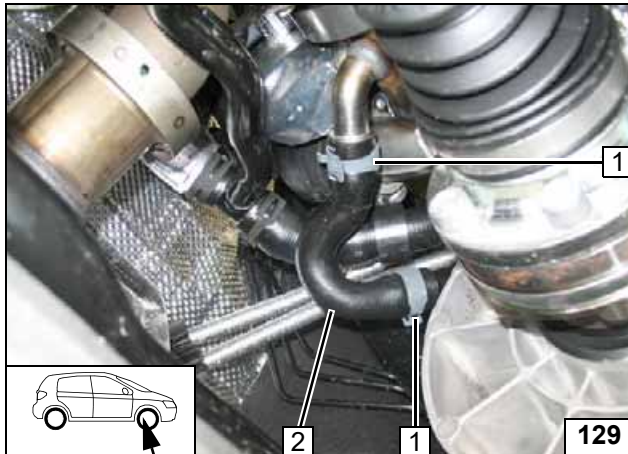

Remove hose from engine outlet/ EGR inlet **2**. Spring clips **1** will be reused.



**Cutting point**

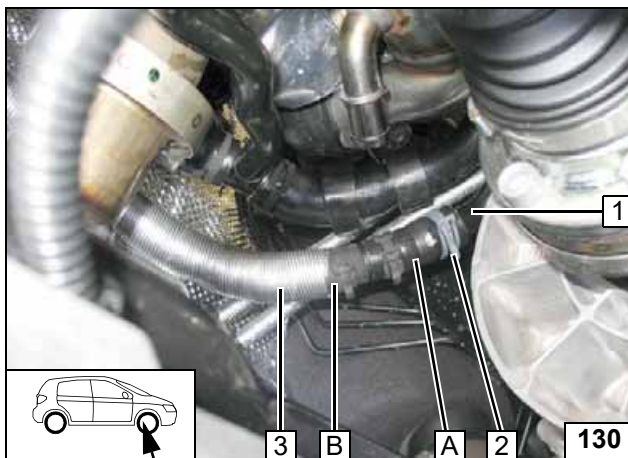

Slide 600mm long heat protection hose **3** onto hose **B**



- 1** Engine outlet pipe
- 2** Original vehicle spring clip

**Connect-  
ing engine  
outlet**

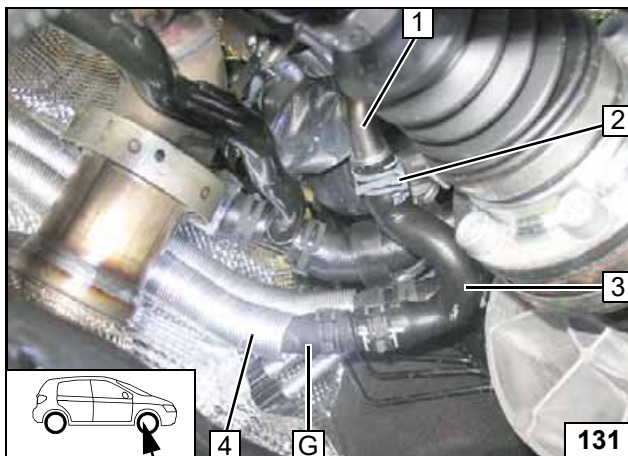

Slide 600mm long heat protection hose **4** onto hose **G**



- 1** EGR pipe
- 2** Original vehicle spring clip
- 3** Original vehicle hose

**Connect-  
ing heat ex-  
changer  
inlet**

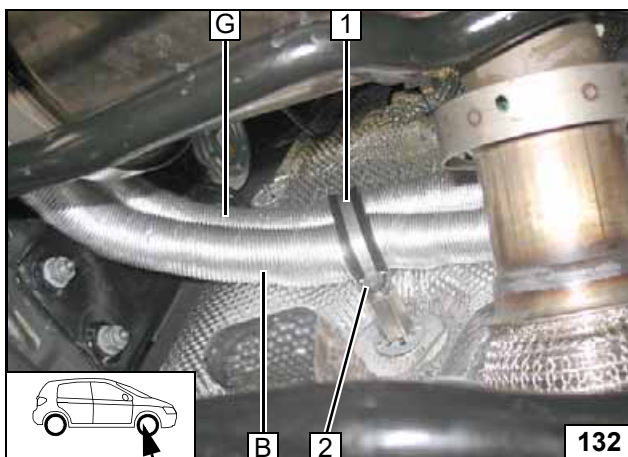

- 1** 48 mm dia. rubber-coated p-clamp
- 2** M6x20 bolt, spring lockwasher

**Fastening on  
firewall**

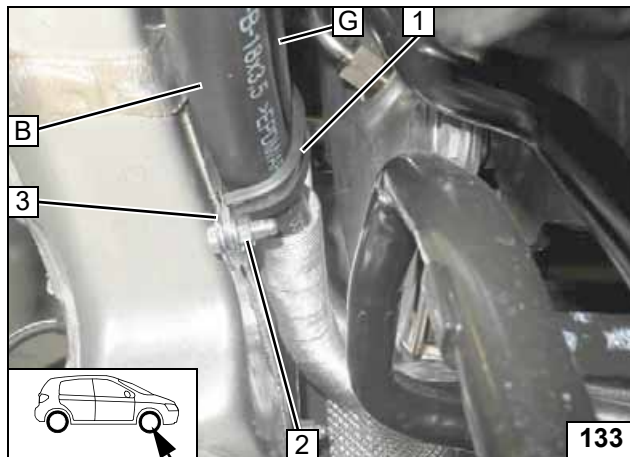
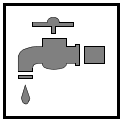

- 1 38 mm dia. rubber-coated p-clamp
- 2 M6x20 bolt, flanged nut
- 3 Perforated bracket

**Routing on frame side member**



Align hoses. Ensure sufficient distance from catalytic converter at position 1, correct if necessary.



**Routing in engine compartment**

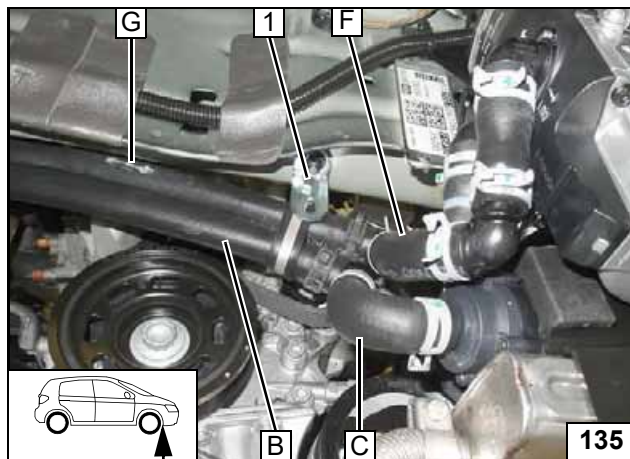

- 1 Tighten bolt

**Connecting heater**

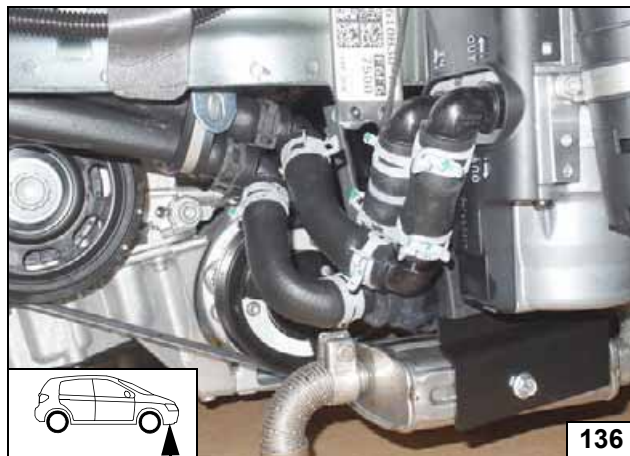

Align hoses and spring clips as shown. Ensure sufficient distance from neighbouring components, correct if necessary.



**Aligning hoses and spring clips**

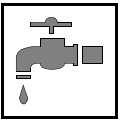

### Coolant Circuit of TDI 4WD



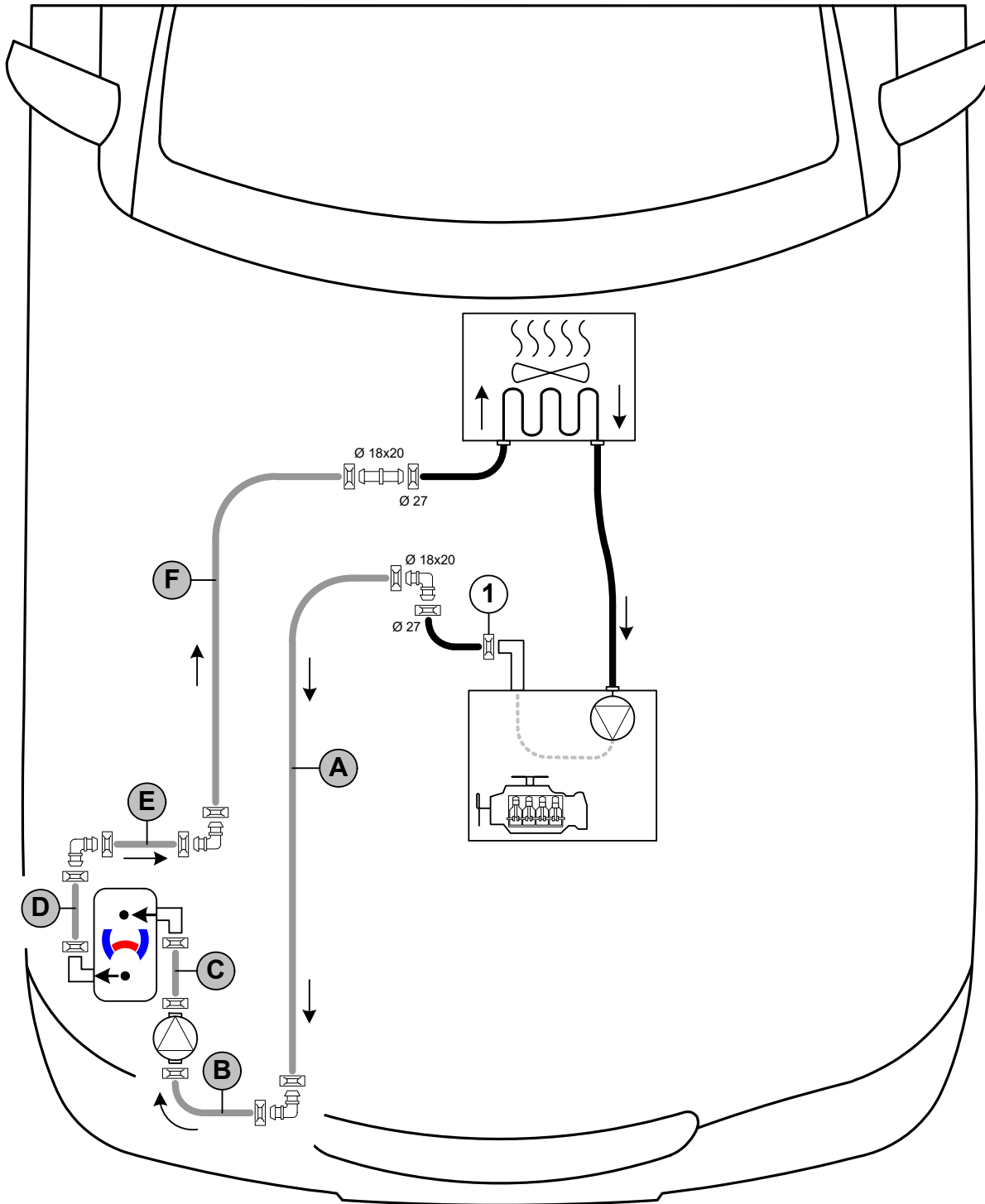

Any coolant running off should be collected in an appropriate container. Route hoses kink-free. Unless specified otherwise, always fasten using cable ties. Position clamps so that other hoses cannot be damaged. The heater must be filled with coolant when installing the hoses.

The connection should be modelled on an 'inline' circuit and based on the following diagram:



Hose routing diagram

All spring clips without a specific designation  = 25 mm dia.  
 All connecting pipes without a specific designation  = 18x18mm dia.  
 1 = Original vehicle spring clip .



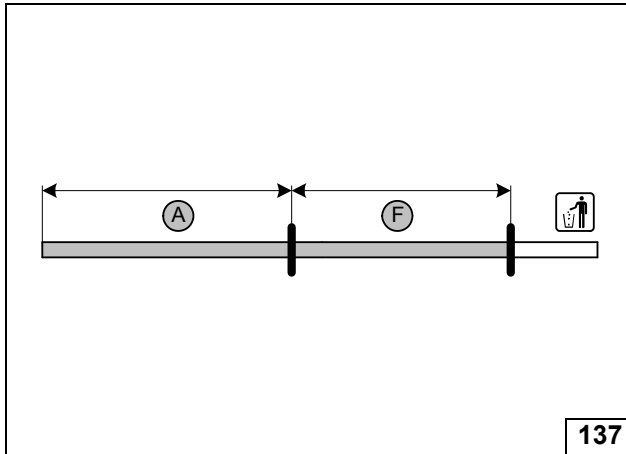
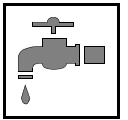

A = 920  
F = 910

**Cutting hoses to length**

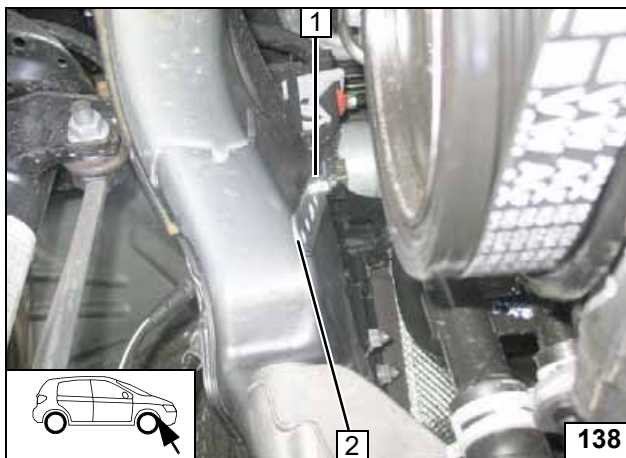

- 1 M6 flanged nut, original vehicle stud bolt
- 2 Perforated bracket

**Installing perforated bracket**

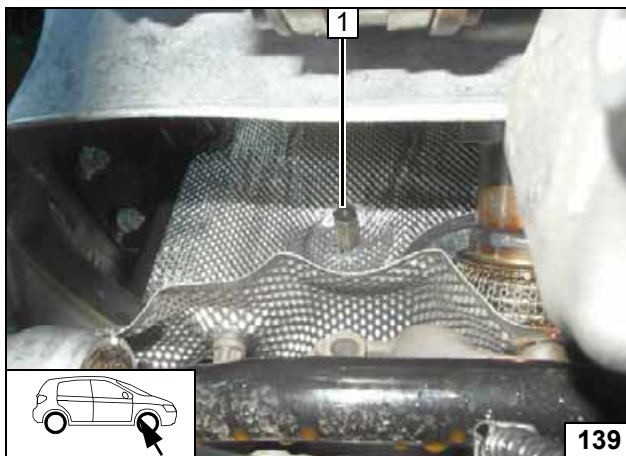

- 1 M6x30 spacer nut, original vehicle stud bolt

**Installing spacer nut**

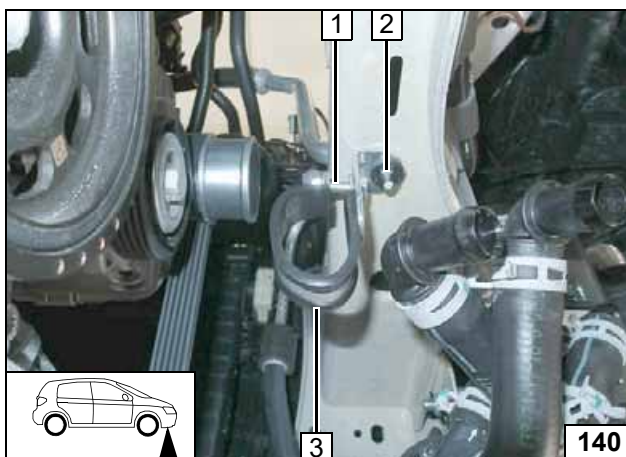

- 1 Install M6x20 bolt loosely
- 2 Original vehicle stud bolt, angle bracket, plastic nut
- 3 38 mm dia. rubber-coated p-clamp

**Installing rubber-coated p-clamp**

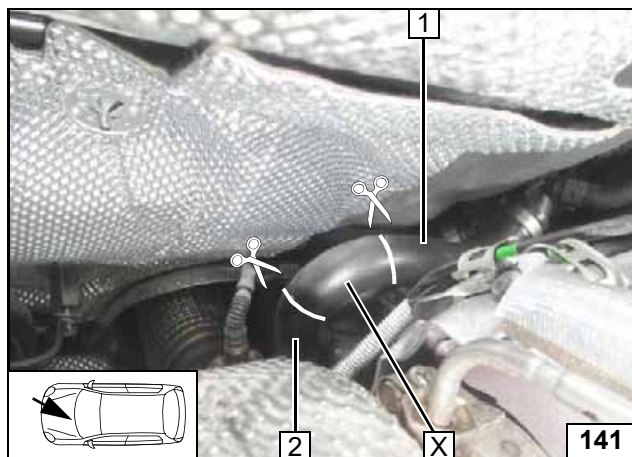
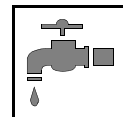

Cut hose of engine outlet / heat exchanger inlet at the markings. Remove engine outlet hose section 2. The spring clip of the engine outlet connection piece will be re-used!



- 1 Heat exchanger inlet hose section

**Cutting point**

X =

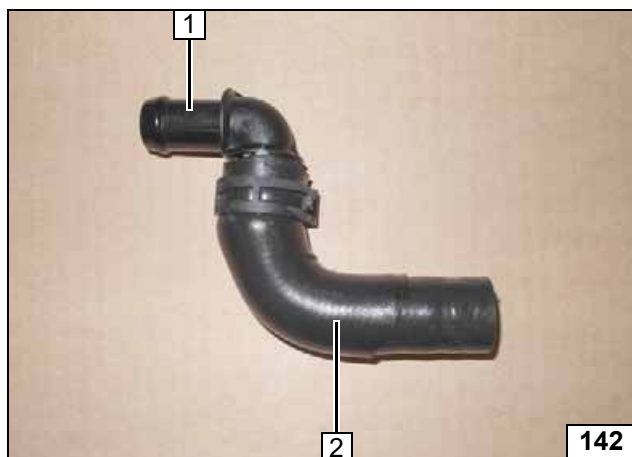

- 1 90°, 18x20mm dia. connecting pipe, 27 mm dia. spring clip
- 2 Engine outlet hose section

**Preparing engine outlet hose section**

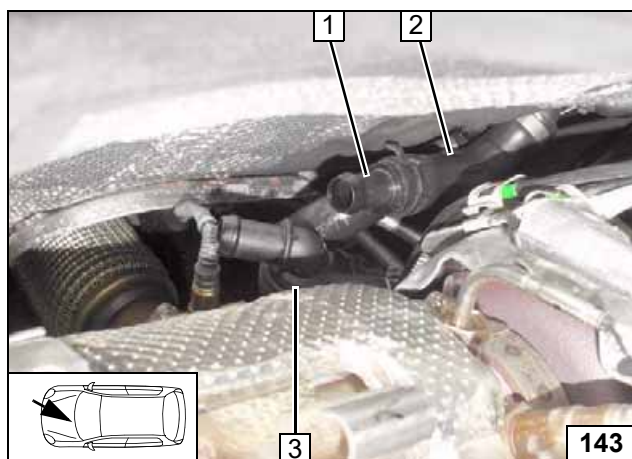

Install engine outlet hose section 3 on engine outlet using original vehicle spring clip.



- 1 18x20mm dia. connecting pipe, 27 mm dia. spring clip
- 2 Heat exchanger inlet hose section

**Mounting engine outlet hose section**

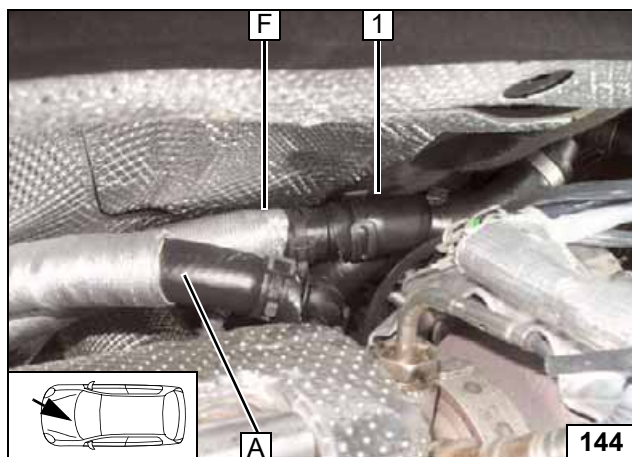

Push one 600 mm long heat protection hose each onto hoses A and F.



- 1 Heat exchanger inlet hose section

**Connecting engine outlet / heat exchanger inlet**



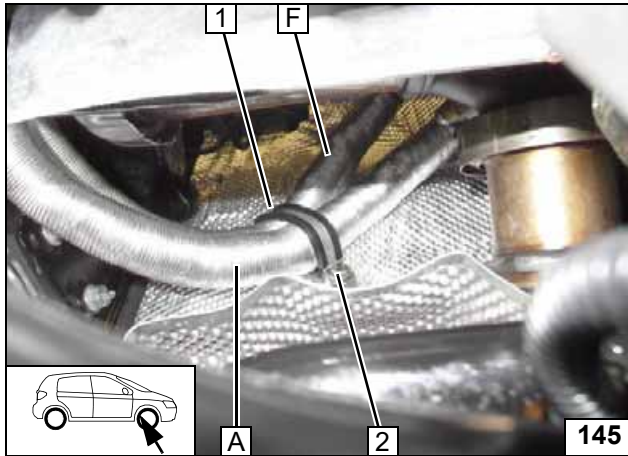
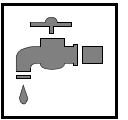

- 1 48 mm dia. rubber-coated p-clamp
- 2 M6x20 bolt, spring lockwasher

Fastening on firewall

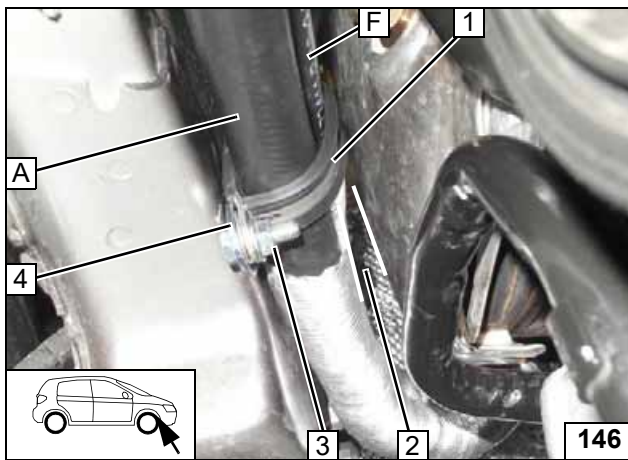

Align hoses. Ensure sufficient distance from catalytic converter at position 2, correct if necessary.



- 1 38 mm dia. rubber-coated p-clamp
- 3 M6x20 bolt, flanged nut
- 4 Perforated bracket

Routing on frame side member

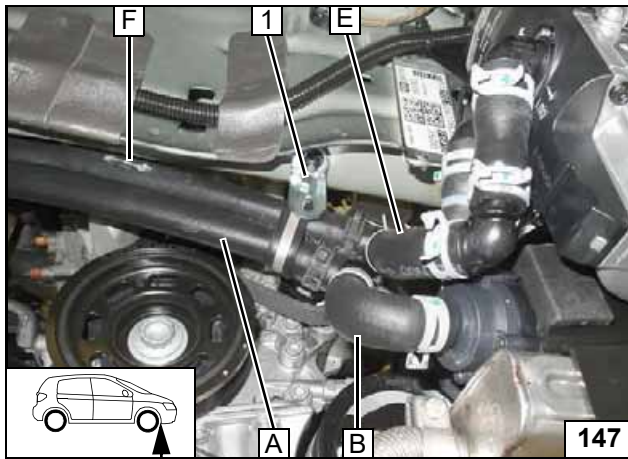
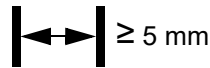

- 1 Tighten bolt

Connecting heater

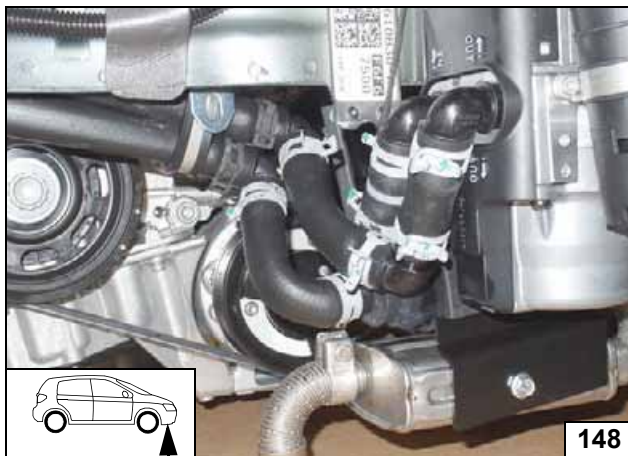

Align hoses and spring clips as shown. Ensure sufficient distance from neighbouring components, correct if necessary.



Aligning hoses and spring clips

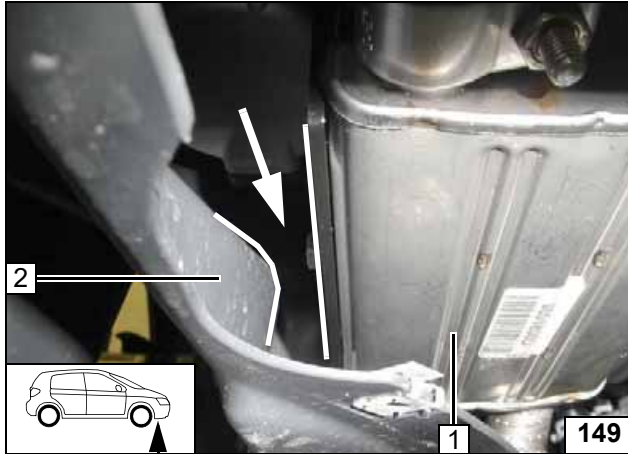
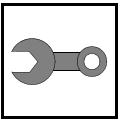

**Final Work**

Ensure sufficient distance between wheel well trim **2** and silencer **1**, correct if necessary.

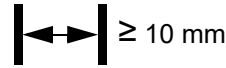

**Aligning exhaust pipe**

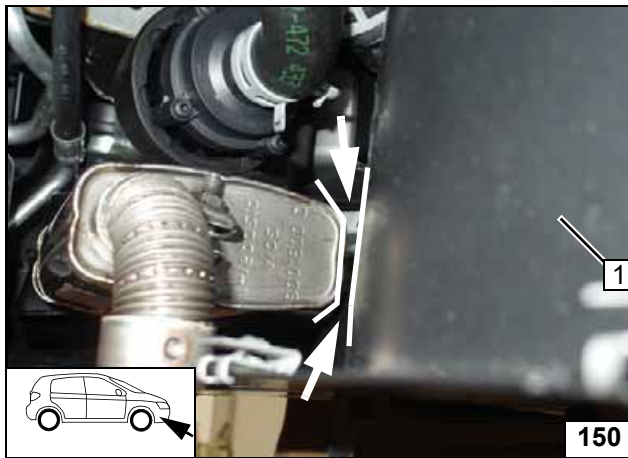

Ensure sufficient distance between exhaust silencer and wheel-well inner panel **1**, correct if necessary.

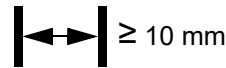

**Aligning silencer**

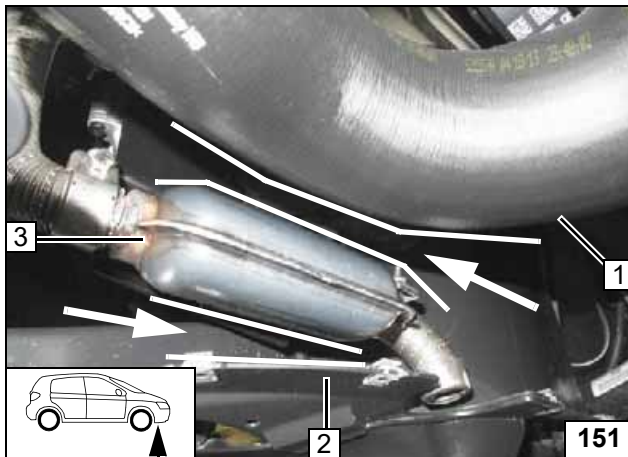

**1.8 TSI**

Ensure sufficient distance between exhaust silencer **3** and wheel-well inner panel **2** as well as charge-air hose **1**, correct if necessary.

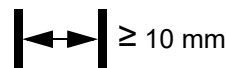

**Aligning exhaust pipe**

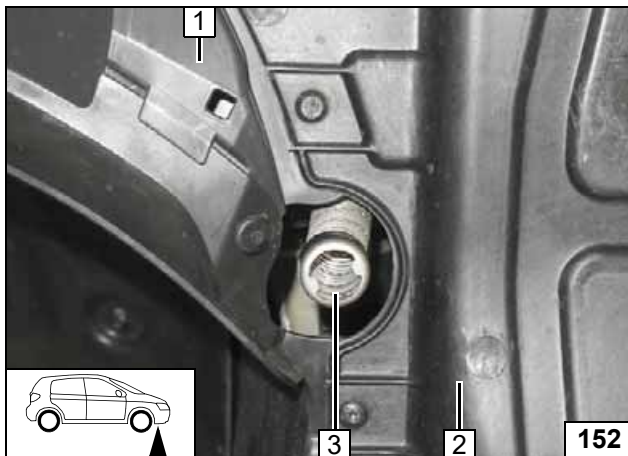

**All vehicles**

Align exhaust outlet **3** with centre of pass through.

- 1 Wheel well trim installed
- 2 Underride protection installed



**Aligning exhaust pipe**

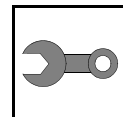

Reassemble the components in reverse order. Check all hoses, clamps and all electrical connections for firm seating. Insulate and tie back loose lines.

Only use manufacturer-approved coolant. Spray the heater components with anti-corrosion wax (Tectyl 100K).

- **Connect the battery.**
- **Fill and bleed the coolant circuit according to the vehicle manufacturer's instructions.**
- **Program MultiControl CAR, teach Telestart transmitter.**
- **For initial startup and function check, please see installation instructions.**
- **If the fan function or A/C control panel settings need to be checked, see the installation documentation in the additional kit 'Webasto Standard' or 'Webasto Comfort' A/C control, section 'Final Work'.**
- **Place the 'Switch off parking heater before refuelling' caution label near the filler neck.**





FuelFix Template for TSI

Top view

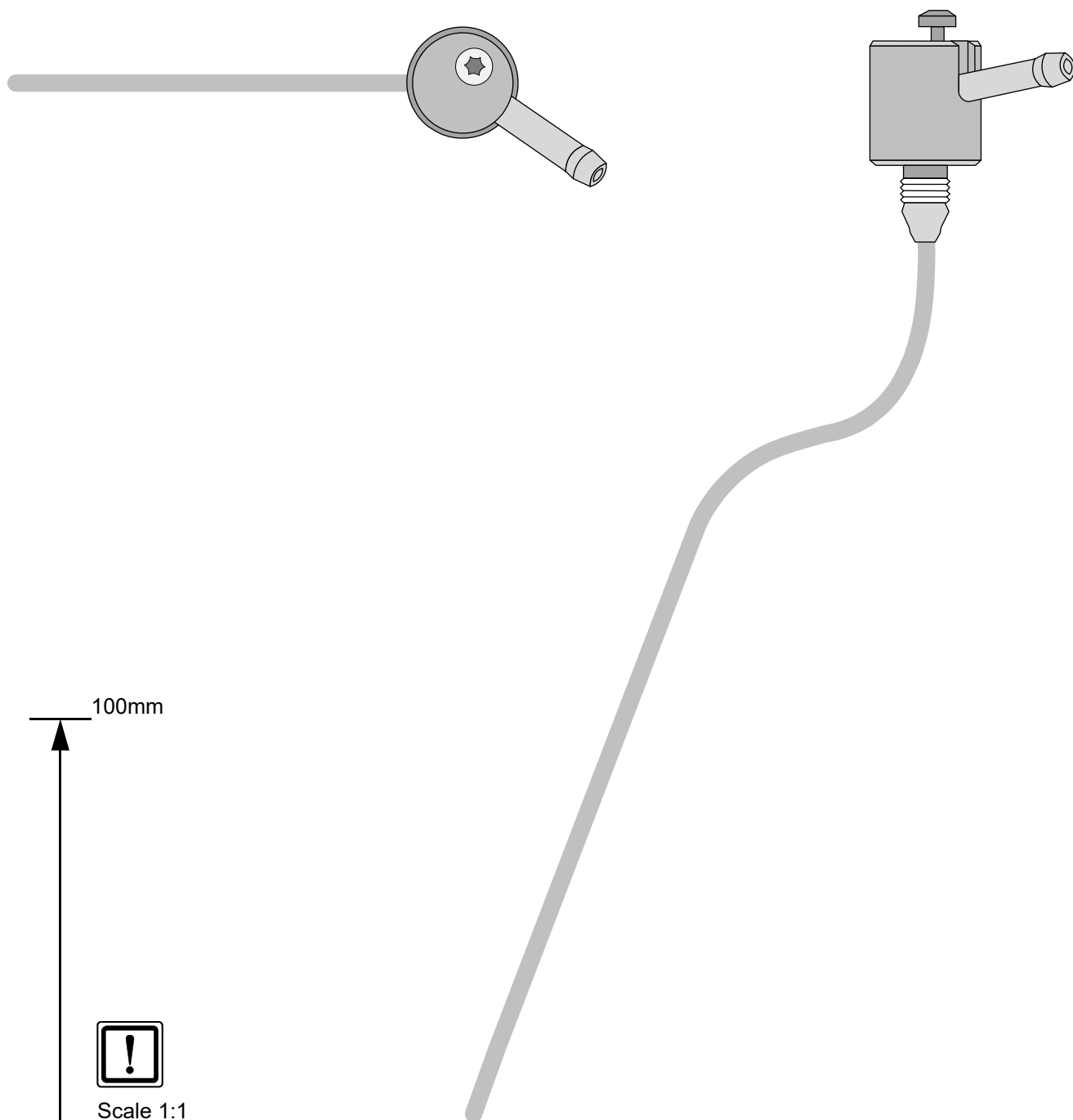

Scale 1:1

Compare size of printout with dimension lines.  
Allowed tolerance a maximum of 2%.

Set the printer settings to 'no margin' or 'minimise margins' and 100% of the normal size.

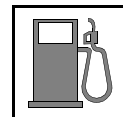

FuelFix Template for TDI

