

## FIAT DUCATO 2.3 MJT "120 HP" - EURO5

Codice/Code: **1FI35901E**

*Comando A.C. "ORIGINALE"  
Commande A.C. "ORIGINAL"  
A.C. Control "ORIGINAL"  
Klimaanlage "ORIGINAL"  
Mando A.C. "ORIGINAL"*

---

**Istruzioni montaggio  
condizionatore d'aria**

**Instructions pour monter le  
conditionneur d'air**

**Air conditioning  
installation instructions**

**Klimaanlage  
Einbauanleitungen**

**Instrucciones para el montaje  
del equipo aire acondicionado**

**DESCRIZIONE SIMBOLOGIA UTILIZZATA / DESCRIPTION DE LA SYMBOLOGIE UTILISÉE  
DESCRIPTION OF SYMBOLS USED / BESCHREIBUNG DER VERWENDETEN SYMBOLIK  
DESCRIPCIÓN DE LOS SIMBOLOS UTILIZADOS**

1A Riferimento a figura / Référence à la figure / See figure  
In Bezug auf Abbildungen / Referencia a la figura

1- 1 Riferimento a componenti di fornitura / Référence aux composants de la fourniture  
See supplied components / Bezug auf Gelieferte Einbauelemente  
Referencia a los componentes de abastecimiento

1 Riferimento a posizione schema elettrico / Référence à la position du schéma électrique  
See position in wiring diagram / In Bezug auf Position im Schaltschema  
Referencia a la posición del esquema eléctrico



- Lubrificare tutti i raccordi e gli O.R. con il nuovo olio refrigerante prima di collegarli

- Graisser tous les raccords et les O.R. avec le nouveau huile réfrigérant avant de les raccorder

-Lubricate all fittings and O-rings with new refrigerant oil before connecting them

- Alle Verbindungsstücke und OR-Ringe vor deren Verbindung mit dem neuen Kühlmittelöl ölen

- Lubrificar todos los empalmes y los O.R. con el nuevo aceite refrigerante antes de conectarlos

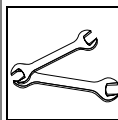

- Per avvitare a fondo o allentare i raccordi tubi gas usare due chiavi per bilanciare coppia di torsione

- Pour visser à fond ou desserrer les raccords des tuyaux gaz, utiliser le deux clés pour équilibrer le couple de torsion

- When tightening or loosening the fittings of the gas pipes, use two wrenches to equalize the torsion couple

- Um die Verbindungsstücke der Kältemittelschläuche gleichmäßig festzuschrauben oder zu lockern, zwei Schlüssel für das Verschraubungspaar verwenden

- Para enroscar a fondo o aflojar los empalmes tubos gas se deben usar dos llaves para balancear el par de torsión



- Tagliare con utensile appropriato al materiale

- Couper à l'aide d'outil approprié

- Cut with a device suitable for the material

- Mit dem Material entsprechendem Werkzeug schneiden

- Cortar con herramienta apropiada al material



- Tagliare con utensile a lama calda

- Couper à l'aide d'un outil à lame chaude

- Cut using the tool with heated blade.

- Mit Schweißmesserwerkzeug schneiden

- Cortar con útil a hoja caliente

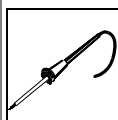

- Stagnare

- Étamer

- Tin

- Verzinnen

- Estañar



- Spianare

- Nivelar

- Flatten out

- Richten

- Nivelar

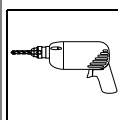

- Forare

- Percer

- To drill

- Durchbohren

- Taladrar

Pos.	ITALIANO	FRANÇAIS	ENGLISH	DEUTSCH	ESPAÑOL
1	Piastra supporto compressore	Plaque support compresseur	Compressor support plate	Kompressorträger	Placa soporte compresor
2	Puleggia motore	Poulie moteur	Driving pulley	Motorriemenscheibe	Polea motor
3	Spina elastica	Goupille élastique	Elastic pin	Spannstift	Perno elástico
4	Attrezzo di centraggio puleggia	Outil de centrage de la poulie	Pulley centering tool	Zentrierungsgerät für Riemenscheibe	Herramienta de centrage polea
5	Staffa di rinforzo	Etrier de renfort	Stiffening bracket	Verstärkungsbügel	Abrazadera de refuerzo
6	Compressore	Compresseur	Compressor	Kompressor	Compresor
6.1	Cablaggio PACKARD per compressore	Câblage PACKARD pour compresseur	PACKARD wiring for compressor	PACKARD Kabelstrang für Kompressor	Cableado PACKARD para compresor
7	Staffa di supporto dispositivo tendicinghia	Etrier support dispositif tendeur du courroie	Belt tightening device support bracket	Haltebügel Spannriemenvorrichtung	Abrazadera de soporte dispositivo tensor de correa
8	Puleggia galoppino	Poulie de renvoi	Idle pulley	Leitrollenriemenscheibe	Polea directriz
9	Eccentrico	Excentrique	Eccentric	Nocken	Excéntrica
10	Perno	Pivot	Pin	Bolzen	Perno
11	Distanziale	Entretoise	Shim	Absandsstück	Distanziador
12	Cinghia	Courroie	Belt	Riemen	Correa
13	Bulloneria	Boulonnerie	Nuts and bolts	Schraubensatz	Tornillería
31	Condensatore	Condenseur	Condenser	Kondensator	Condensador
32	Sacchetto accessori	Sachet accessoires	Bag of accessories	Säckchen mit Zuberhörteilen	Bolsita accesorios
35	Distanziale	Entretoise	Shim	Absandsstück	Distanziador
36	Supporto condensatore	Support condenseur	Condenser support	Kondensatorhalter	Suporte condensador
39	Staffa ausiliaria di supporto Impianto elettrico elettroventole	Etrier auxiliaire de support équipement électrique ventilateurs	Auxiliary support bracket for fan wiring	Zusatz-Halterungsbügel der elektrischen Anlage des Gebläses	Abrazadera auxiliar de soporte Instalación eléctrica electro-ventiladores
40	Copri-relais	Couvre-relais	Relay cover	Relais-Verkleidung	Cubre-realais
41	Sacchetto flangia	Sachet bride	Bag of flanges	Säckchen mit Flansch	Bolsita brida
42	Staffa di supporto tubi gas	Etrier support des tuyaux gaz	Gas pipe support bracket	Kältemittelschlauch Haltebügel	Abrazadera de soporte tubos gas
43-49	Fascetta in gomma	Collier en caoutchouc	Rubber clamp	Gummischelle	Banda de goma
44-45 50	Fermatubo	Fixation tuyau	Pipe clamp	Schlauchbinder	Detiene tubo
46	Protezione a spirale	Protection en spirale	Spiral protection	Spiralförmige Ummantelung	Protección a espiral
51	Filtro essiccatore	Filtre déshydrateur	Receiver drier	Trocknerfilter	Filtro secador
52	Staffa filtro	Etrier filtre	Receiver drier bracket	Filterbügel	Abrazadera filtro
53	Pressostato	Pressostat	Pressure switch	Druckwächter	Presostato
61	Batteria evaporante	Batterie évaporateur	Evaporating unit	Verdampferbatterie	Batería evaporante
62	Sacchetto accessori	Sachet accessoires	Bag of accessories	Säckchen mit Zuberhörteilen	Bolsita accesorios
63	Distributore tubi gas	Distributeur tuyaux gaz	Gas pipe distributor	Kältemittelschlauchverteiler	Distribuidor tubos gas

Pos.	ITALIANO	FRANÇAIS	ENGLISH	DEUTSCH	ESPAÑOL
64	Termostato	Thermostat	Thermostat	Thermostat	Termostato
65	Staffa supporto termostato	Etrier support thermostat	Thermostat support bracket	Thermostat-Haltebügel	Abrazadera soporte termostato
66	Molla fissaggio bulbo	Ressort fixation bulbe	Thermoswitch fixing spring	Kolben-befestigungsfeder	Muelle de fijación del bulbo
67	Pomello	Bouton	Knob	Drehkopf	Pomo
68	Mastice anticondensa	Mastic anti-condensation	Condensation-proofing material	Kondensierwasserdichtmasse	Masilla anticondensación
69	Fascetta LOOPING	Collier LOOPING	Clamp LOOPING	Schelle LOOPING	Banda LOOPING
70	Tubo scarico condensa	Tuyau d'écoulement des condensations	Condensate drain pipe	Kondensierwasserabflussschlauch	Tubo descarga condensación
71	Valvola di espansione	Soupape d'expansion	Expansion valve	Expansionsventil	Válvula expansión
72	Flangia fissaggio valvola	Bride de fixation soupape	Valve fixing flange	Ventil-Befestigungsflansch	Brida de fijación de la válvula
91	Impianto elettrico comandi	Faisceau électrique commandes	Electrical system for controls	Elektrische Anlage der Bedienungseinheit	Instalación eléctrica comandos
92	Giunzione RAYCHEM BLU	Raccord RAYCHEM BLEU	BLUE RAYCHEM connector	RAYCHEM Verbindung BLAU	Junta RAYCHEM TURQUI
93	Giunzione RAYCHEM ROSSA	Raccord RAYCHEM ROUGE	RED RAYCHEM connector	RAYCHEM Verbindung ROT	Junta RAYCHEM ROJO
94	Connettore PACKARD 1 via	Connecteur PACKARD à 1 voie	1-way PACKARD connector	1-Weg-PACKARD-Steckverbinder	Conector PACKARD 1 vía
100	Mascherina comandi	Plaque commandes	Control panel	Steuerungshalterung	Mascarilla mandos
106	Impianto elettrico elettroventole	Installation électrique electroventilateurs	Fans electric system	Elektrische Anlage Elektrolüfter	Instalación eléctrica electroventiladores
107	Terminale	Borne	Terminal	Endstecker	Terminale
108	Giunzione RAYCHEM ROSSA	Raccord RAYCHEM ROUGE	RED RAYCHEM connector	RAYCHEM Verbindung ROT	Junta RAYCHEM ROJO
109	Cablaggio supplementare	Câblage supplémentaire	Supplementary wiring	Zusatz-Kabelstrang	Cableado suplementario
	Tubo gas 5/16"CF (condensatore-filtro)	Tuyau gaz 5/16"CF (condenseur-filtre)	5/16"CF gas hose (condenser-filter)	5/16"CF kaeltemittelschlauch (Kondensator-Filter)	Tubo gas 5/16"CF (condensador-filtro)
	Tubo gas 5/16"FE (filtro-evaporatore)	Tuyau gaz 5/16"FE (filtre-évaporateur)	5/16"FE gas hose (filter-evaporator)	5/16"FE kaeltemittelschlauch (Filter-Verdampfer)	Tubo gas 5/16"FE (filtro-evaporador)
	Tubo gas 13/32"CC (compressore-condensatore)	Tuyau gaz 13/32"CC (compresseur-condenseur)	13/32"CC gas hose (compressor-condenser)	13/32"CC kaeltemittelschlauch (Kompressor-Kondensator)	Tubo gas 13/32"CC (compresor-condensador)
	Tubo gas 1/2"EC (evaporatore-compressore)	Tuyau gaz 1/2"EC (évaporateur-compresseur)	1/2"EC gas hose (evaporator-compressor)	1/2"EC kaeltemittelschlauch (Verdampfer-Kompressor)	Tubo gas 1/2"EC (evaporador-compresor)
	Fascetta a strappo	Bride auto-bloquant	Self-locking clamp	Selbstsichernde Schelle	Banda autobloqueante



**MONTAGGIO COMPRESSORE / POSE DU COMPRESSEUR / COMPRESSOR FITTING  
KOMPRESSOREINBAU / MONTAJE COMPRESOR**

MATERIALE FORNITO / MATERIEL FOURNI / SUPPLIED MATERIAL / GELIEFERTES MATERIAL / MATERIAL ABASTECIDO

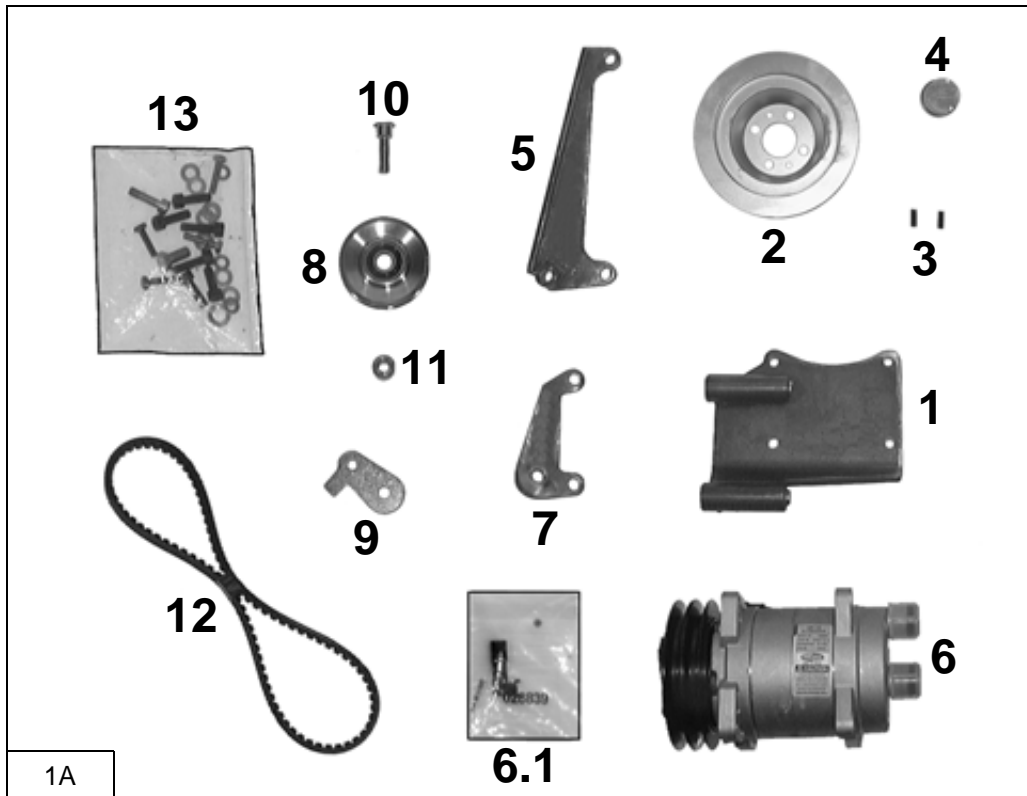

1A

Pos.	Descrizione / Description / Description / Beschreibung / Descripción	Codice / Code Kode / Código
1	Piastra supporto compressore	0011176/0
2	Puleggia motore	003743/1
3	Spina elastica $\phi 5 \times 16$	007151/0
4	Attrezzo di centraggio puleggia	009900/0
5	Staffa di rinforzo	0021652/0
6	Compressore	015200/1
6.1	Cablaggio PACKARD per compressore	0282113/1
7	Staffa di supporto dispositivo tendicinghia	0021651/0
8	Puleggia galoppino	004008/2
9	Eccentrico	006138/0
10	Perno	005042/0
11	Distanziale $\phi 10 \times \phi 20 \times 15$	009402ZN
12	Cinghia 13x887	013022/0
13	Bulloneria	037FI197/1

## OPERAZIONI PRELIMINARI / OPERATIONS PRELIMINAIRES / PRELIMINARY OPERATIONS VORBEREITUNGSARBEITEN / OPERACIONES PRELIMINARES

**(I)**  
**NEL VANO MOTORE:**

- Scollegare la batteria;
- Smontare la grembialina inferiore di protezione motore;
- Allentare al cinghia di trasmissione e smontare la puleggia motore.

**(GB)**  
**IN THE ENGINE COMPARTMENT:**

- Disconnect the battery;
- Remove the lower engine protection screen;
- Loosen the transmission belt and remove the driving pulley.

**(E)**  
**EN EL COMPARTIMIENTO MOTOR:**

- Desconectar la batería;
- Desmontar la pantalla inferior de protección motor;
- Aflojar la correa de transmisión y desmontar la pulea motor.

**(F)**  
**DANS LE COMPARTIMENT MOTEUR:**

- Déconnecter la batterie;
- Déposer l'écran de protection inférieure du moteur;
- Desserrer la courroie d'entraînement et déposer la poulie moteur.

**(D)**  
**IM MOTORRAUM:**

- Die Batterie disconnect;
- Untere Motorabdeckung abbauen;
- Antriebsriemen lockern und Motorriemenscheibe ausbauen.

FORI DI FISSAGGIO / TROUS DE FIXATION  
SECURING HOLES / BEFESTIGUNGSBOHRUNGEN  
ORIFICIOS DE FIJACIÓN

2A

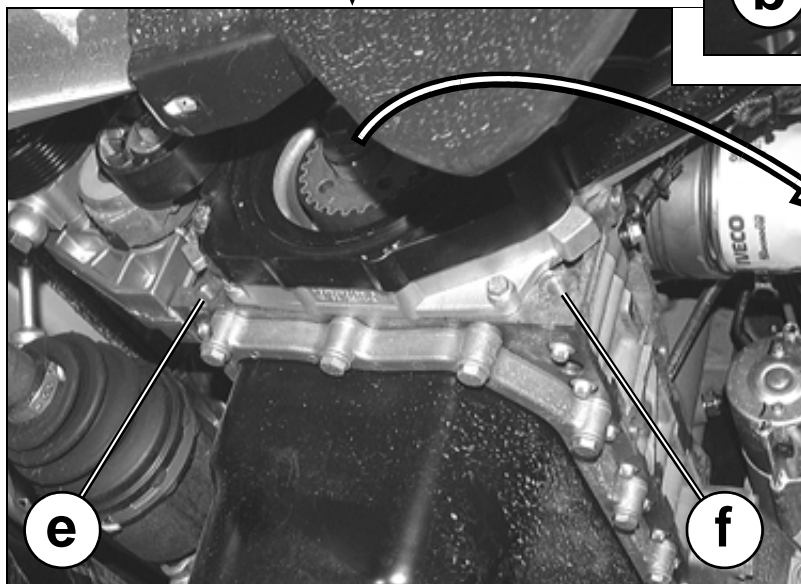
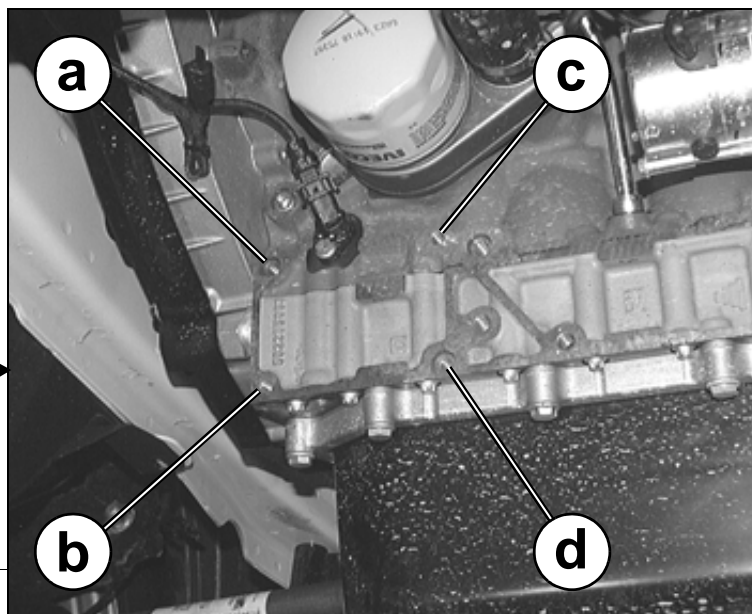

SMONTARE  
DEMONTER  
REMOVE  
AUSBAUEN  
DESMONTAR

ELIMINARE  
ELIMINER  
DISCARD  
ENTFERNEN  
ELIMINAR

UNIRE / UNIR / COMBINE / VERBINDEN / UNIR

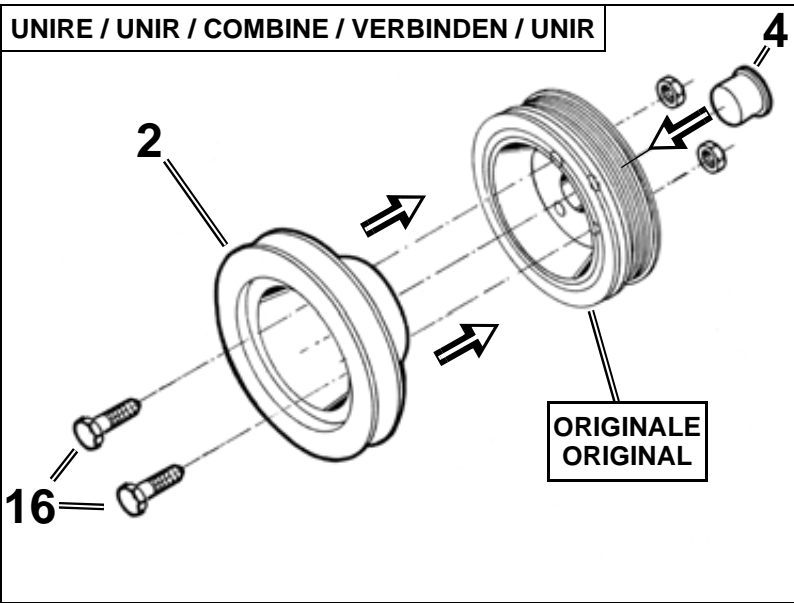

(I)  
Per permettere l'istallazione delle due pulegge abbinata è necessario abbassare leggermente il blocco motore, allentando elementi di fissaggio del supporto destro.

(F)  
Pour permettre l'installation des deux poulies couplées il faut baisser légèrement le bloc moteur, en desserrant les éléments de fixation du support de droite.

(GB)  
To permit installation of two combined pulleys, the engine block must be lowered slightly by loosening the securing elements on the right support.

(D)  
Um den Einbau der beiden zu kombinierenden Riemenscheiben zu erlauben, ist es notwendig die Befestigungselemente der rechten Trägers zu lockern und den Motorblock leicht nach unten zu versetzen.

(E)  
Para permitir la instalación de las dos poleas acopladas es necesario bajar ligeramente el bloque motor, aflojando elementos de fijación del soporte derecho.

3A

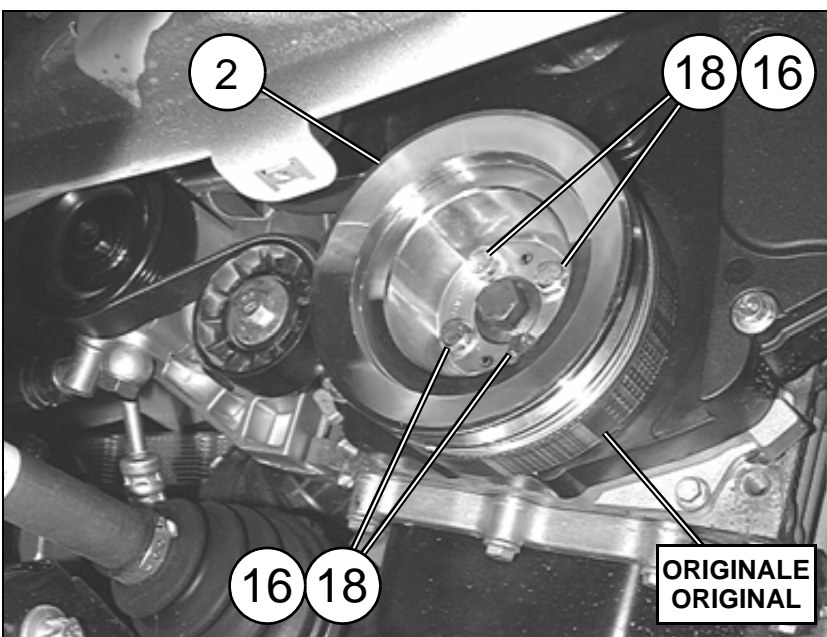
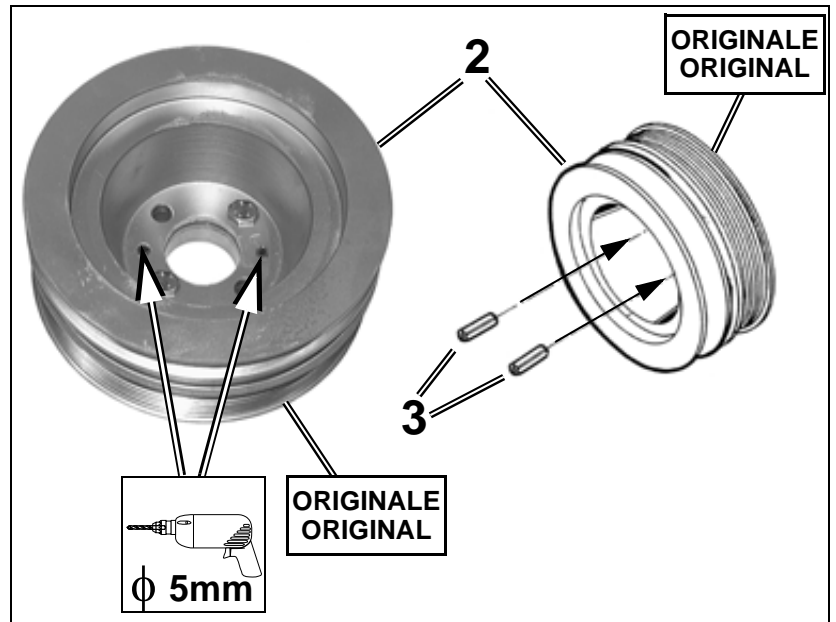

BULLONERIA DA UTILIZZARE BOULONNERIE A UTILISER NUTS AND BOLTS TO BE USED ZU BENUTZENDER SCHRAUBENSATZ TORNILLERIA A UTILIZAR		
Pos.	Tipologia Typologie Typology Tipologie Tipologia	Descrizione Description Description Beschreibung Descripción
16		M8x50
18		φ8xφ16x1,9

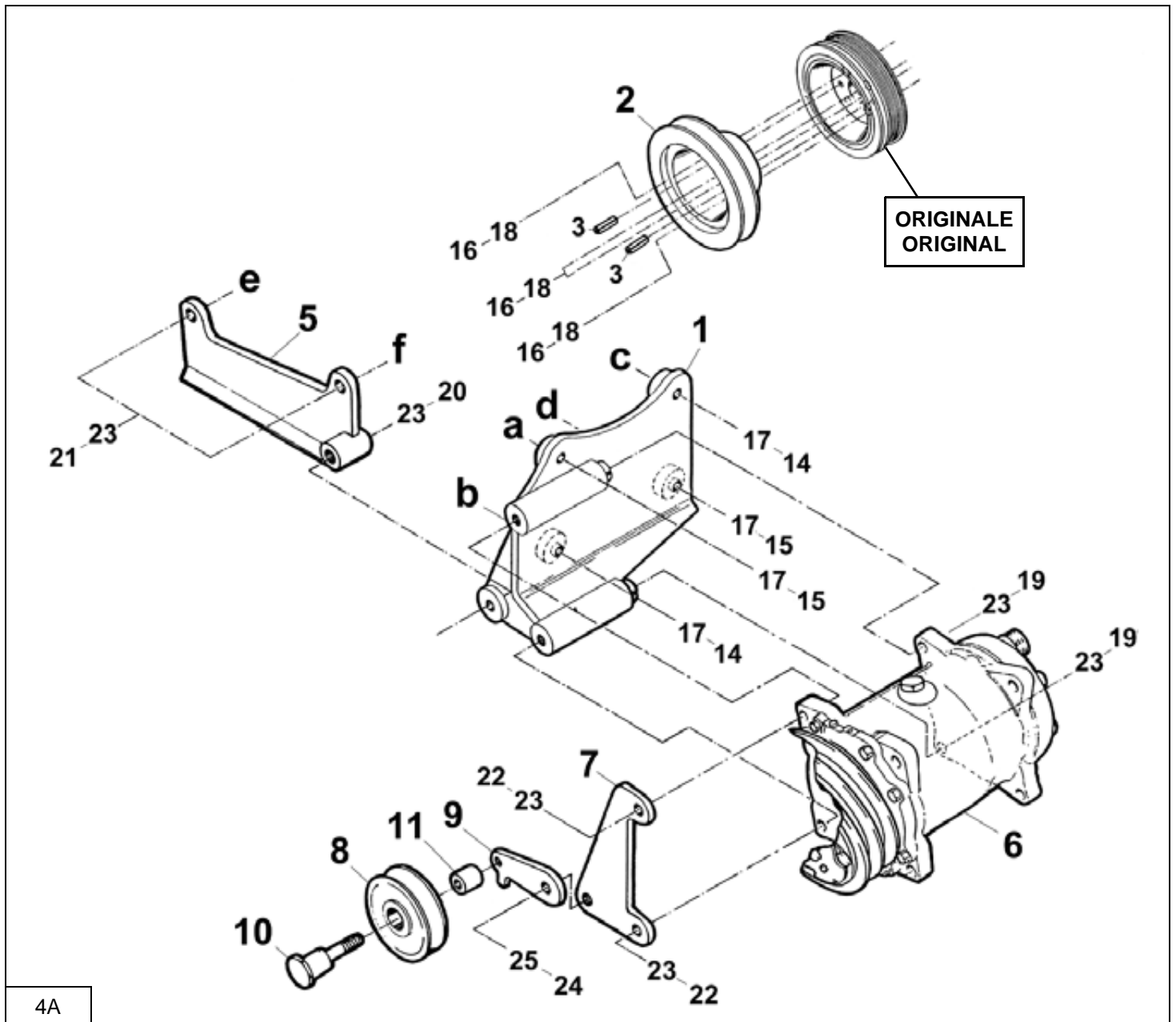

BULLONERIA DA UTILIZZARE BOULONNERIE A UTILISER NUTS AND BOLTS TO BE USED ZU BENUTZENDER SCHRAUBENSATZ TORNILLERIA A UTILIZAR		
Pos.	Tipologia Typologie Typology Tipologie Tipologia	Descrizione Description Description Beschreibung Descripción
14		M8x30
15		M8x35
16		M8x50
17		φ8xφ17

BULLONERIA DA UTILIZZARE BOULONNERIE A UTILISER NUTS AND BOLTS TO BE USED ZU BENUTZENDER SCHRAUBENSATZ TORNILLERIA A UTILIZAR		
Pos.	Tipologia Typologie Typology Tipologie Tipologia	Descrizione Description Description Beschreibung Descripción
18		φ8xφ16x1,9
19		M10x35
20		M10x40
21		M10x1,25x30

BULLONERIA DA UTILIZZARE BOULONNERIE A UTILISER NUTS AND BOLTS TO BE USED ZU BENUTZENDER SCHRAUBENSATZ TORNILLERIA A UTILIZAR		
Pos.	Tipologia Typologie Typology Tipologie Tipologia	Descrizione Description Description Beschreibung Descripción
22		M10x35
23		φ10xφ21
24		M12x1,25x30
25		φ12



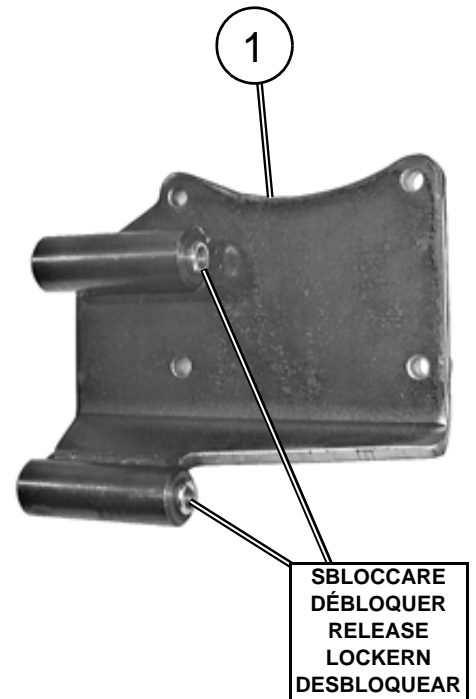
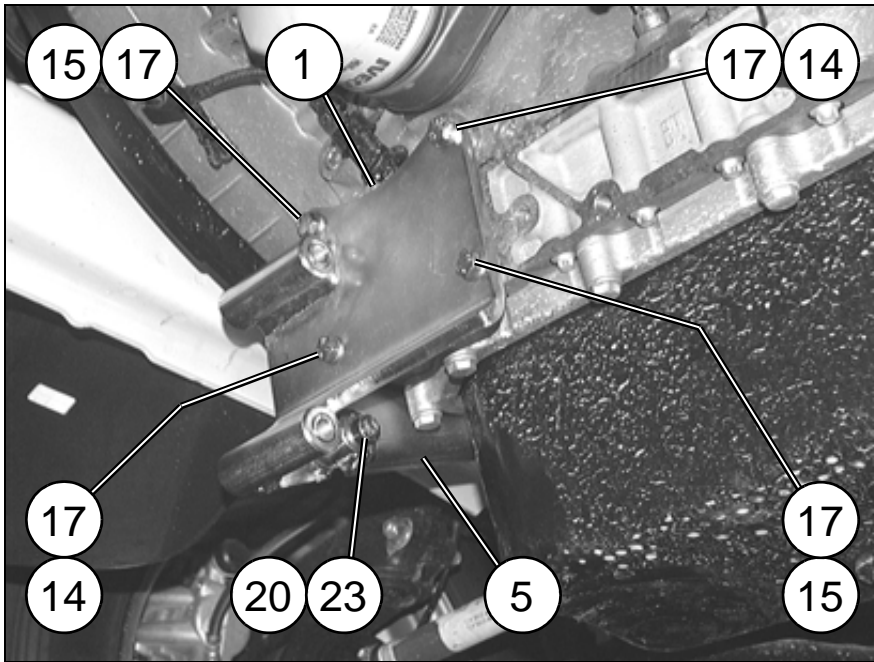

5A

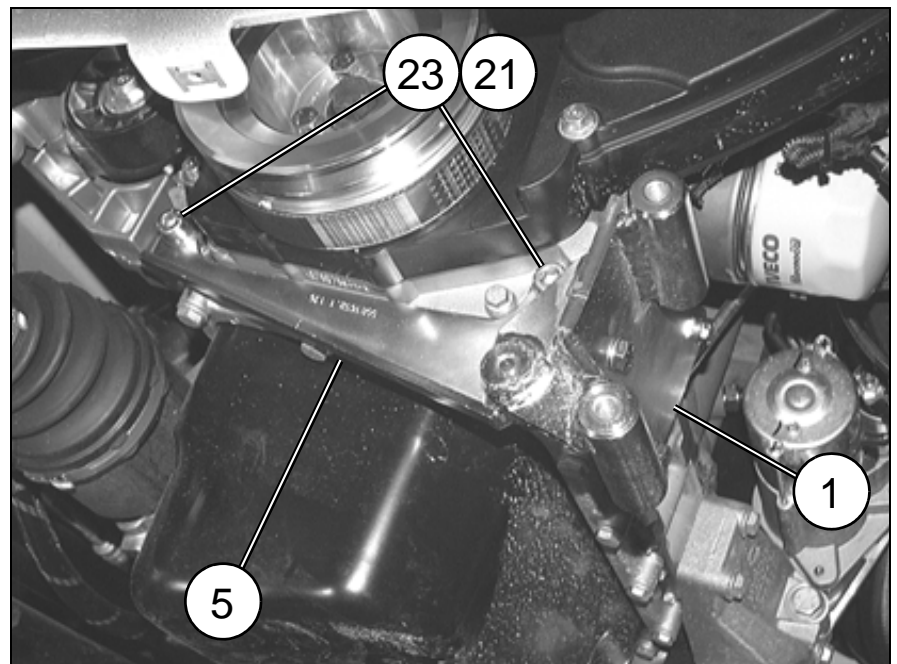

BULLONERIA DA UTILIZZARE BOULONNERIE A UTILISER NUTS AND BOLTS TO BE USED ZU BENUTZENDER SCHRAUBENSATZ TORNILLERIA A UTILIZAR		
Pos.	Tipologia Typologie Typology Tipologie Tipologia	Descrizione Description Description Beschreibung Descripción
14		M8x30
15		M8x35

BULLONERIA DA UTILIZZARE BOULONNERIE A UTILISER NUTS AND BOLTS TO BE USED ZU BENUTZENDER SCHRAUBENSATZ TORNILLERIA A UTILIZAR		
Pos.	Tipologia Typologie Typology Tipologie Tipologia	Descrizione Description Description Beschreibung Descripción
17		$\phi 8 \times \phi 17$
20		M10x40

BULLONERIA DA UTILIZZARE BOULONNERIE A UTILISER NUTS AND BOLTS TO BE USED ZU BENUTZENDER SCHRAUBENSATZ TORNILLERIA A UTILIZAR		
Pos.	Tipologia Typologie Typology Tipologie Tipologia	Descrizione Description Description Beschreibung Descripción
21		M10x1,25x30
23		$\phi 10 \times \phi 21$

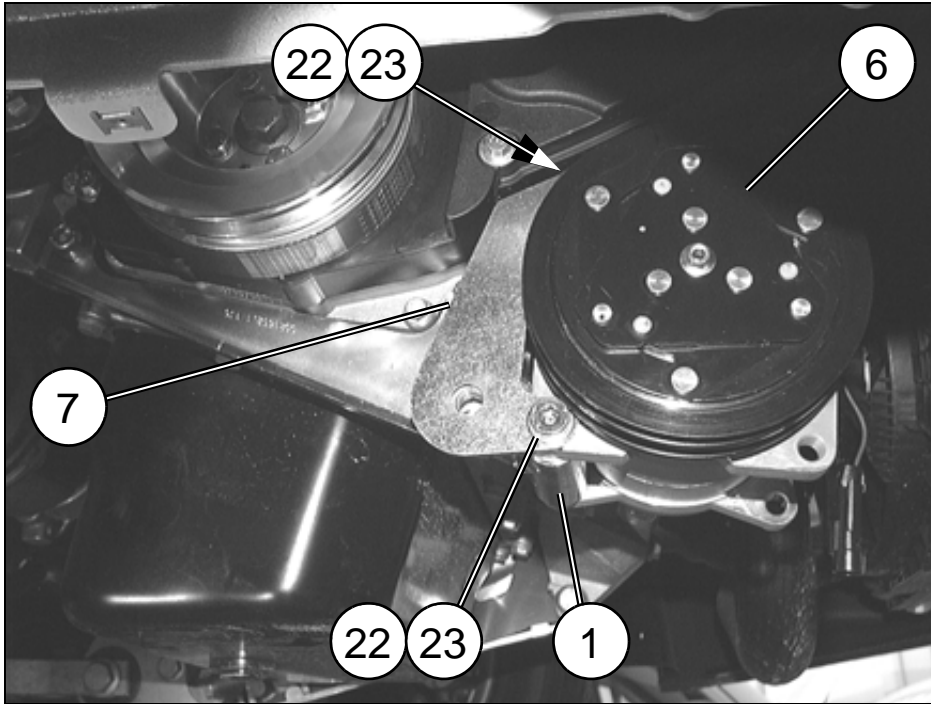

6A

BULLONERIA DA UTILIZZARE BOULONNERIE A UTILISER NUTS AND BOLTS TO BE USED ZU BENUTZENDER SCHRAUBENSATZ TORNILLERIA A UTILIZAR		
Pos.	Tipologia Typologie Typology Tipologie Tipologia	Descrizione Description Description Beschreibung Descripción
19		M10x35
22		M10x35
23		φ10xφ21

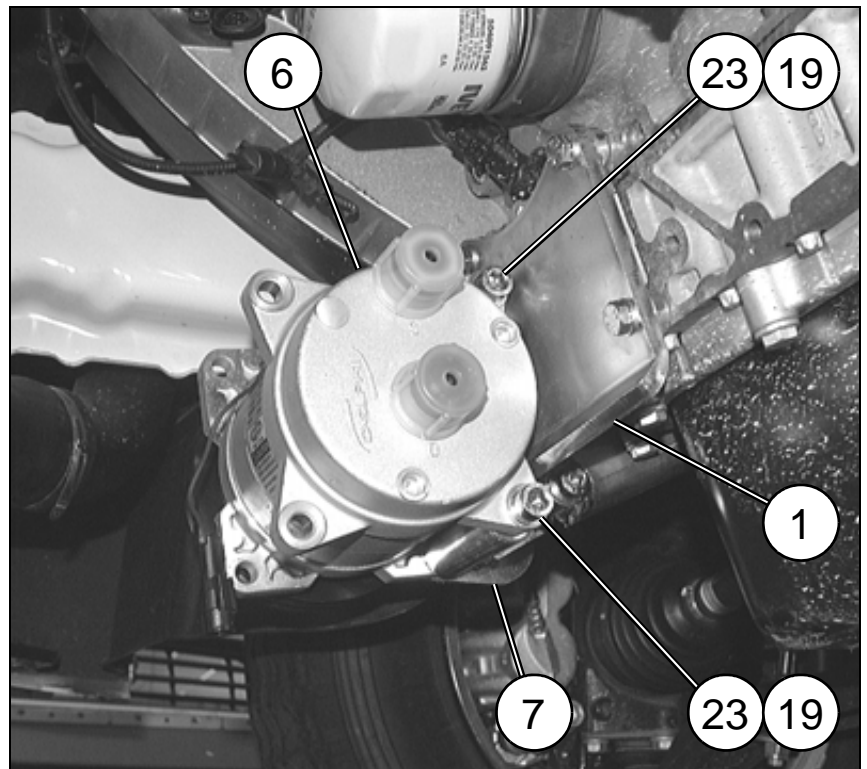

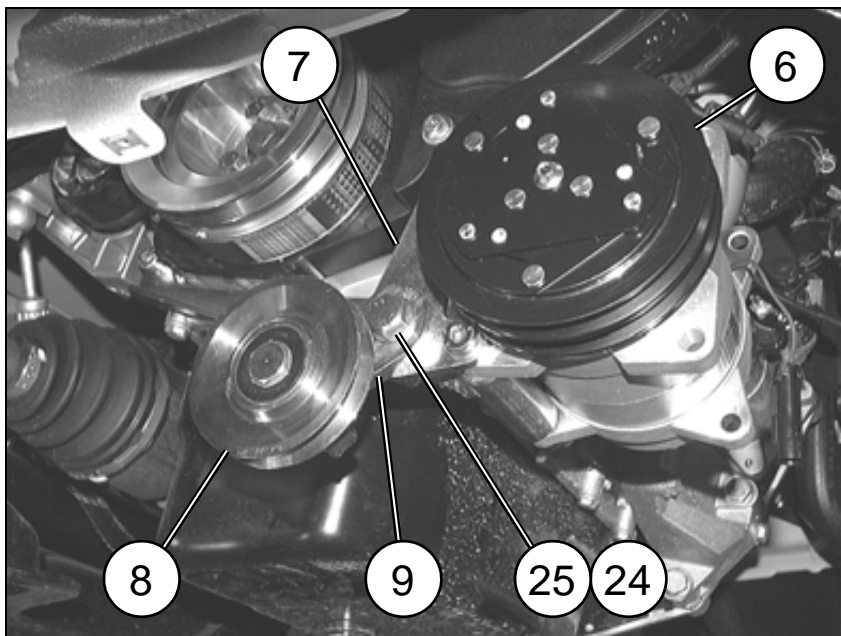
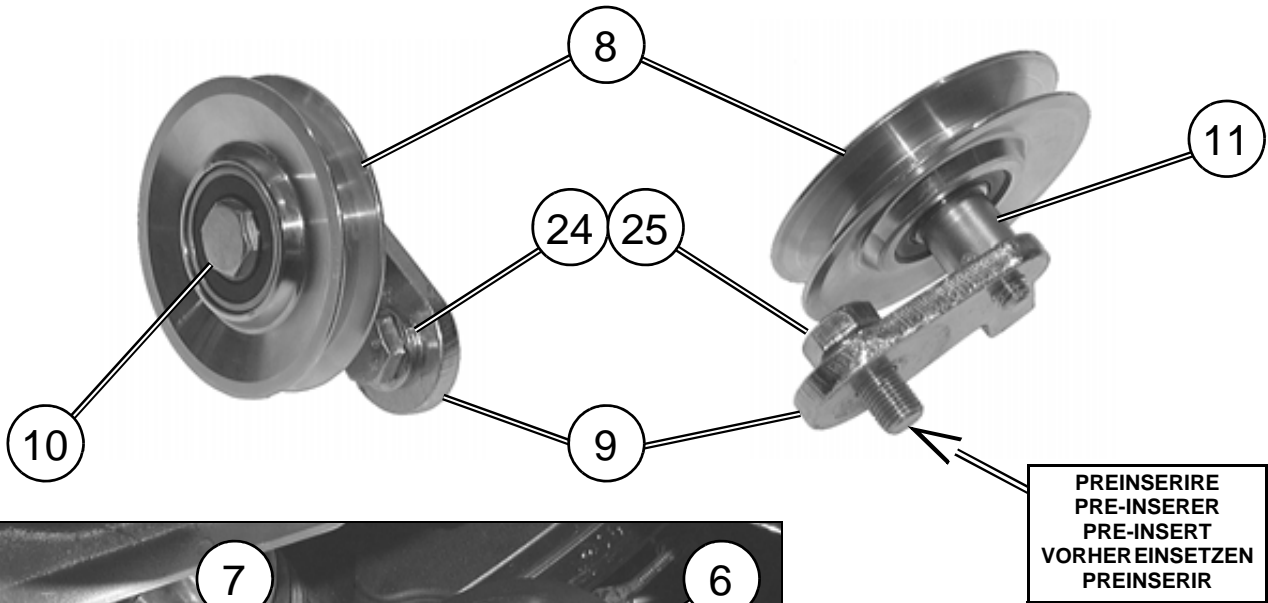

BULLONERIA DA UTILIZZARE BOULONNERIE A UTILISER NUTS AND BOLTS TO BE USED ZU BENUTZENDER SCHRAUBENSATZ TORNILLERIA A UTILIZAR		
Pos.	Tipologia Typologie Typology Tipologie Tipologia	Descrizione Description Description Beschreibung Descripción
24		M12x1,25x30
25		φ12

7A

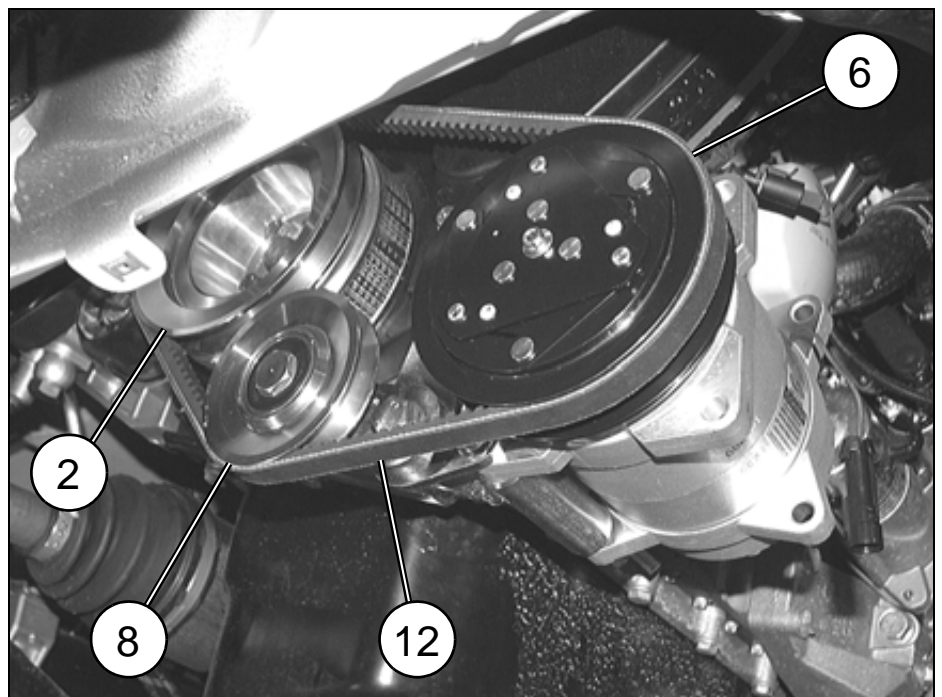



**MONTAGGIO CONDENSATORE / POSE DU CONDENSEUR / CONDENSER FITTING  
KONDENSATOREINBAU / MONTAJE CONDENSADOR**

MATERIALE FORNITO / MATERIEL FOURNI / SUPPLIED MATERIAL / GELIEFERTES MATERIAL / MATERIAL ABASTECIDO

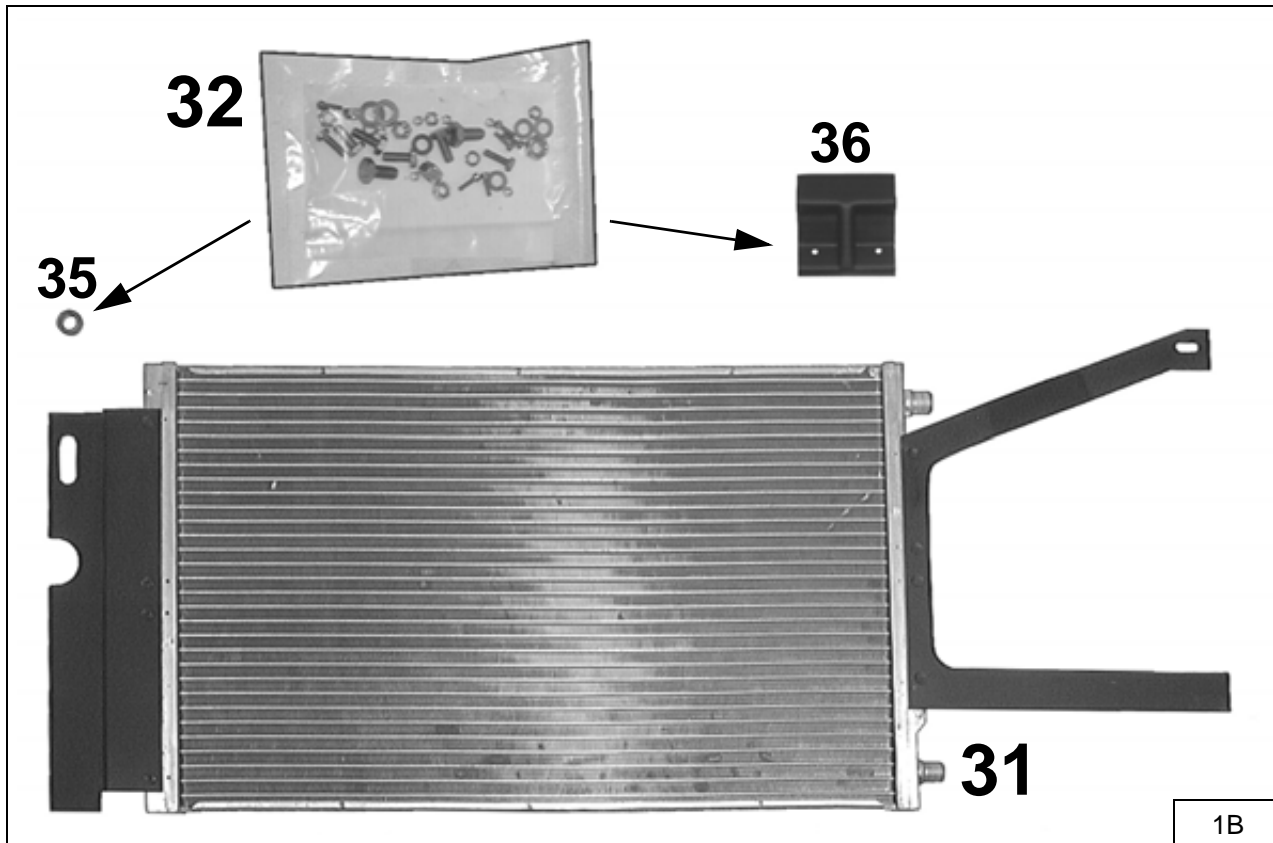

Pos.	Descrizione / Description / Description Beschreibung / Descripción	Codice / Code Kode / Código
31	Condensatore	024137/0
32	Sacchetto accessori	0232126/0
35	Distanziale $\phi 20 \times \phi 12 \times 9$	009966/0
36	Supporto condensatore	0322141/0



ELEMENTI DI FISSAGGIO / PIECES DE FIXATION FIXING PARTS / BEFESTIGUNGSELEMENTE ELEMENTOS DE FIJACION		
Pos.	Tipologia Typologie Typology Typologie Tipologia	Descrizione Description Description Beschreibung Descripción
31.2		6 x 20

2B

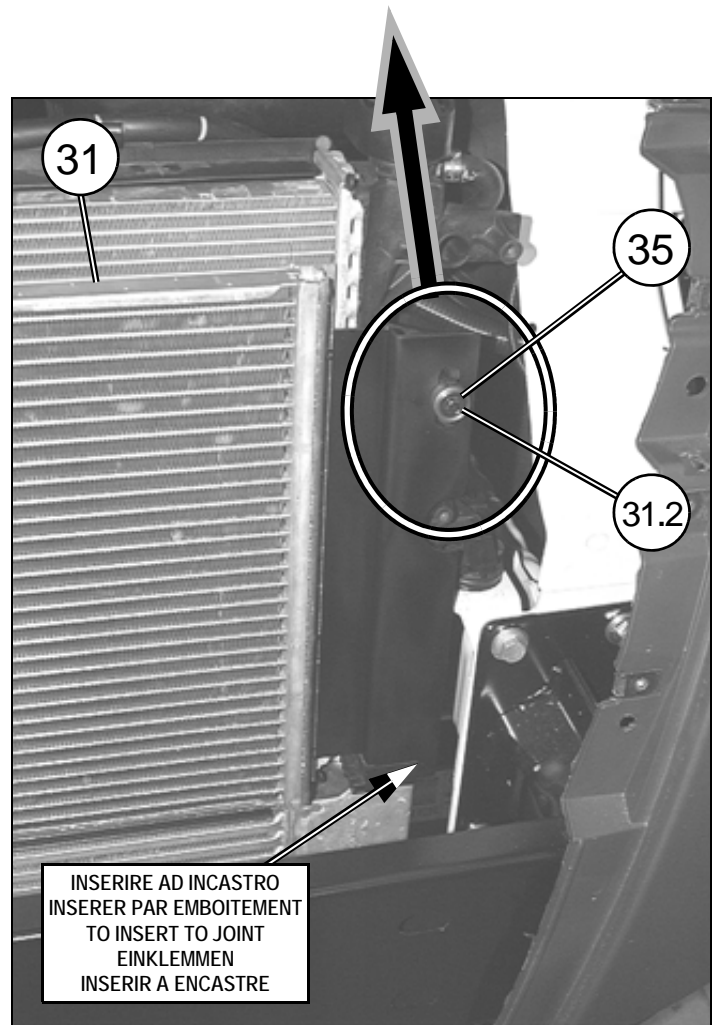
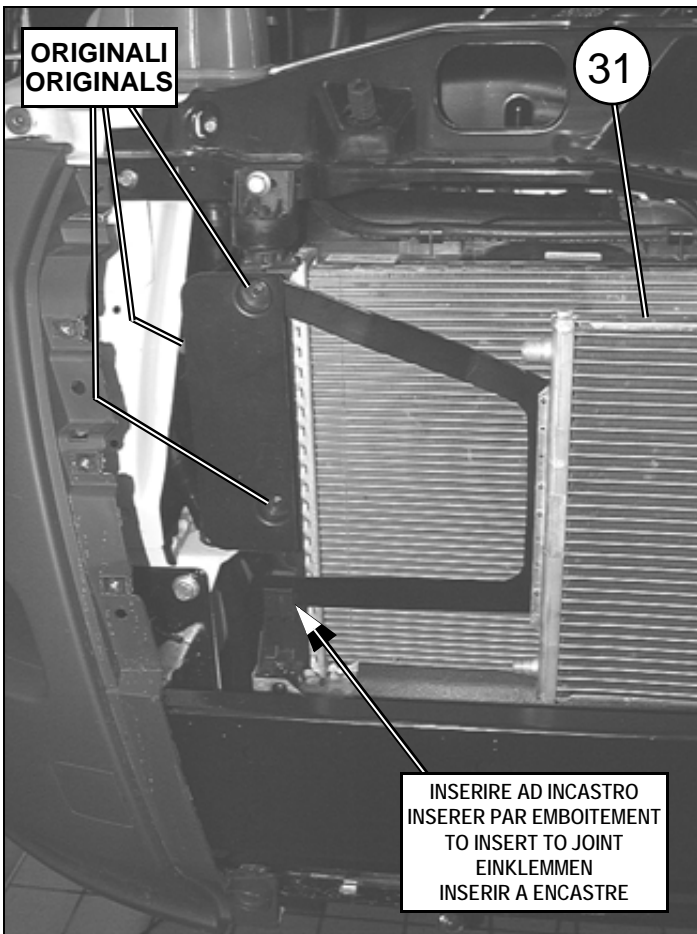
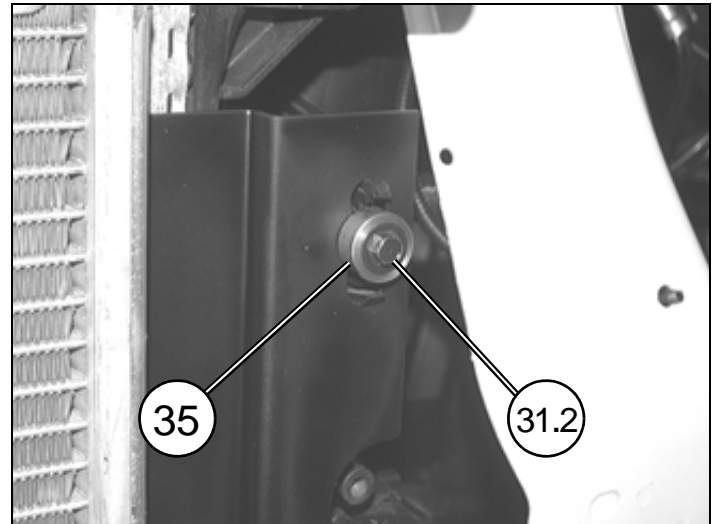

3B

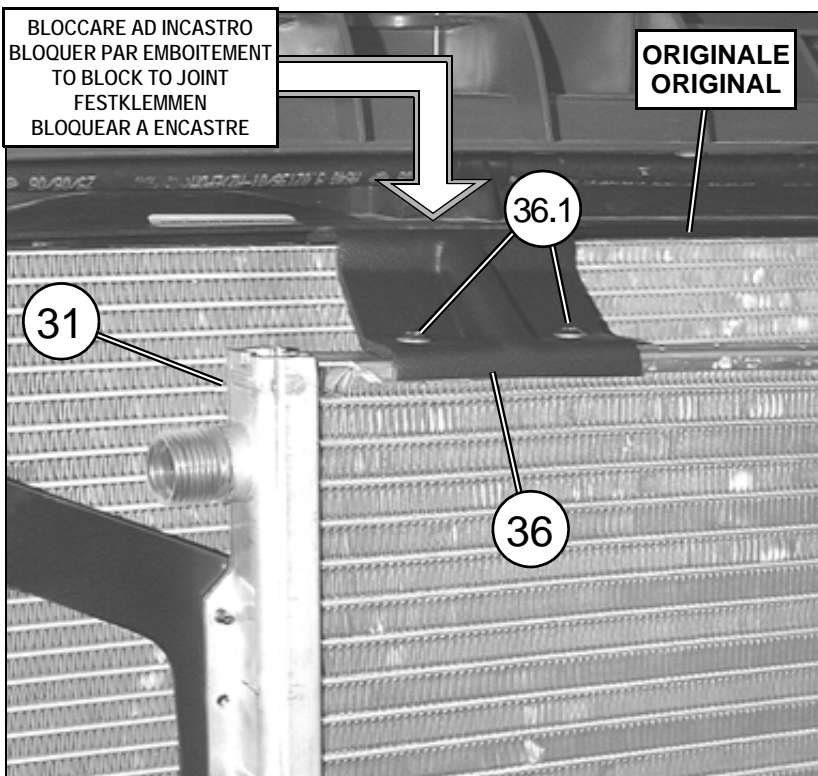
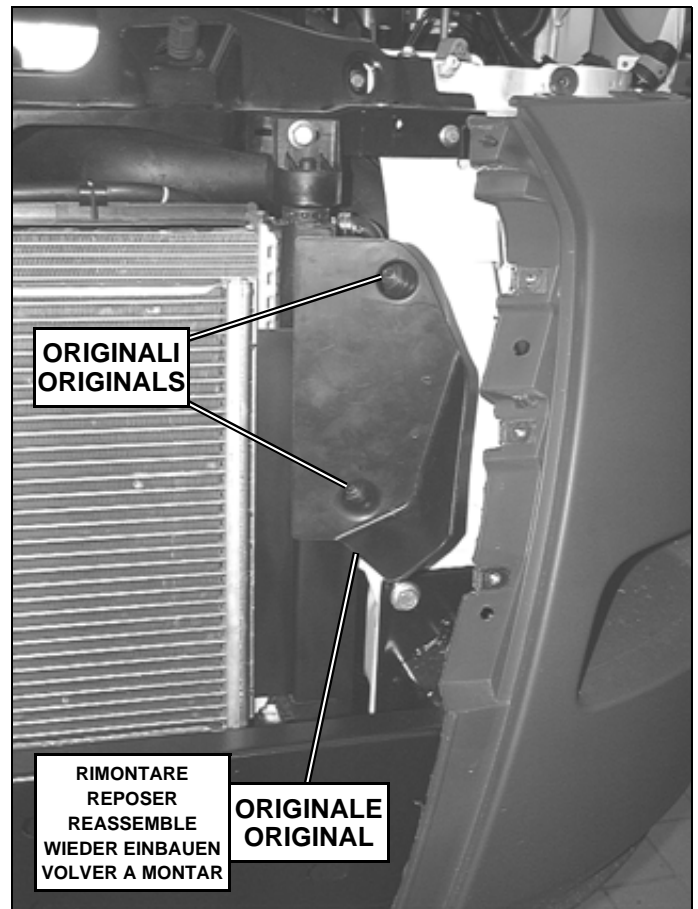

4B

ELEMENTI DI FISSAGGIO / PIECES DE FIXATION FIXING PARTS / BEFESTIGUNGSELEMENTE ELEMENTOS DE FIJACION		
Pos.	Tipologia / Typologie Typology / Tipologie Tipologia	Descrizione / Description Description / Beschreibung Descripción
36.1		4,2 x 9,5

**MONTAGGIO FILTRO ESSICCATORE / POSE DU FILTRE DESHYDRATEUR / RECEIVER DRIER ASSEMBLY  
TROCKNERFILTER EINBAU / MONTAJE DEL FILTRO SECADOR**

**MATERIALE FORNITO / MATERIEL FOURNI / SUPPLIED MATERIAL / GELIEFERTES MATERIAL / MATERIAL ABASTECIDO**

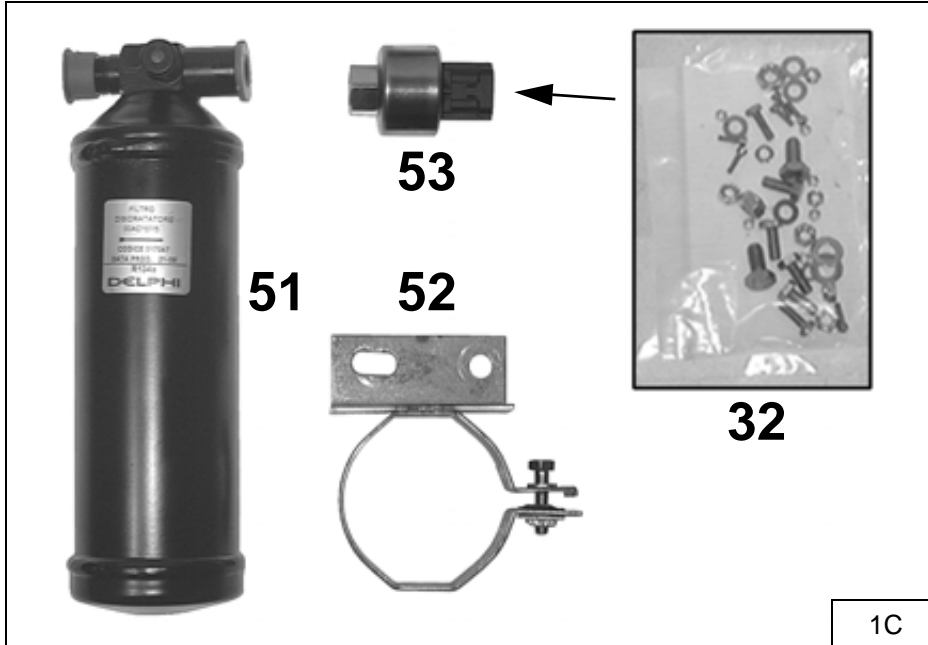

Pos.	Descrizione / Description / Description Beschreibung / Descripción	Codice / Code Kode / Código
32	Sacchetto accessori	0232126/0
51	Filtro essiccatore	017047/1
52	Staffa filtro	0361819/0
53	Pressostato	043396/0

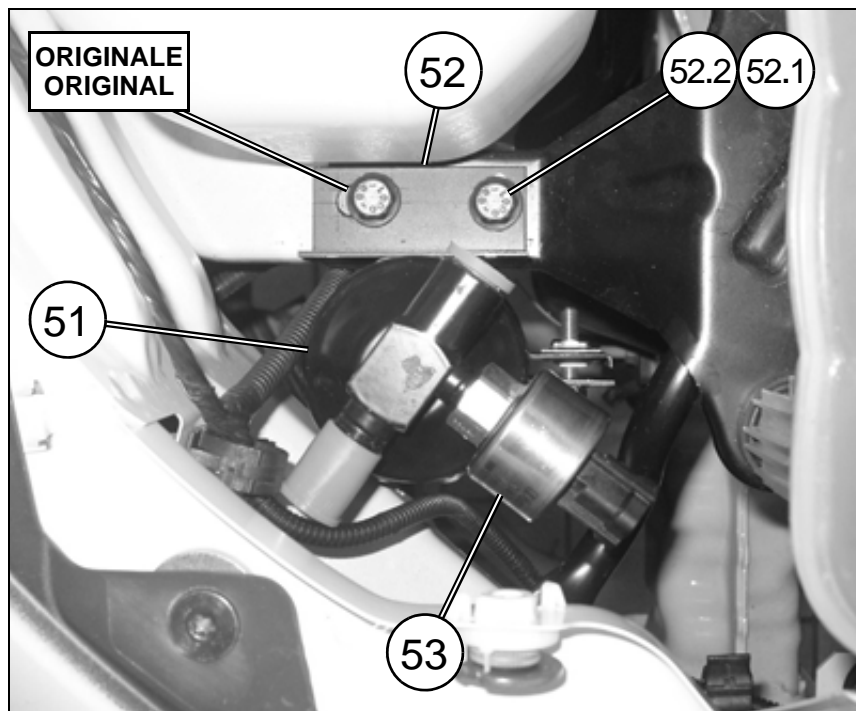
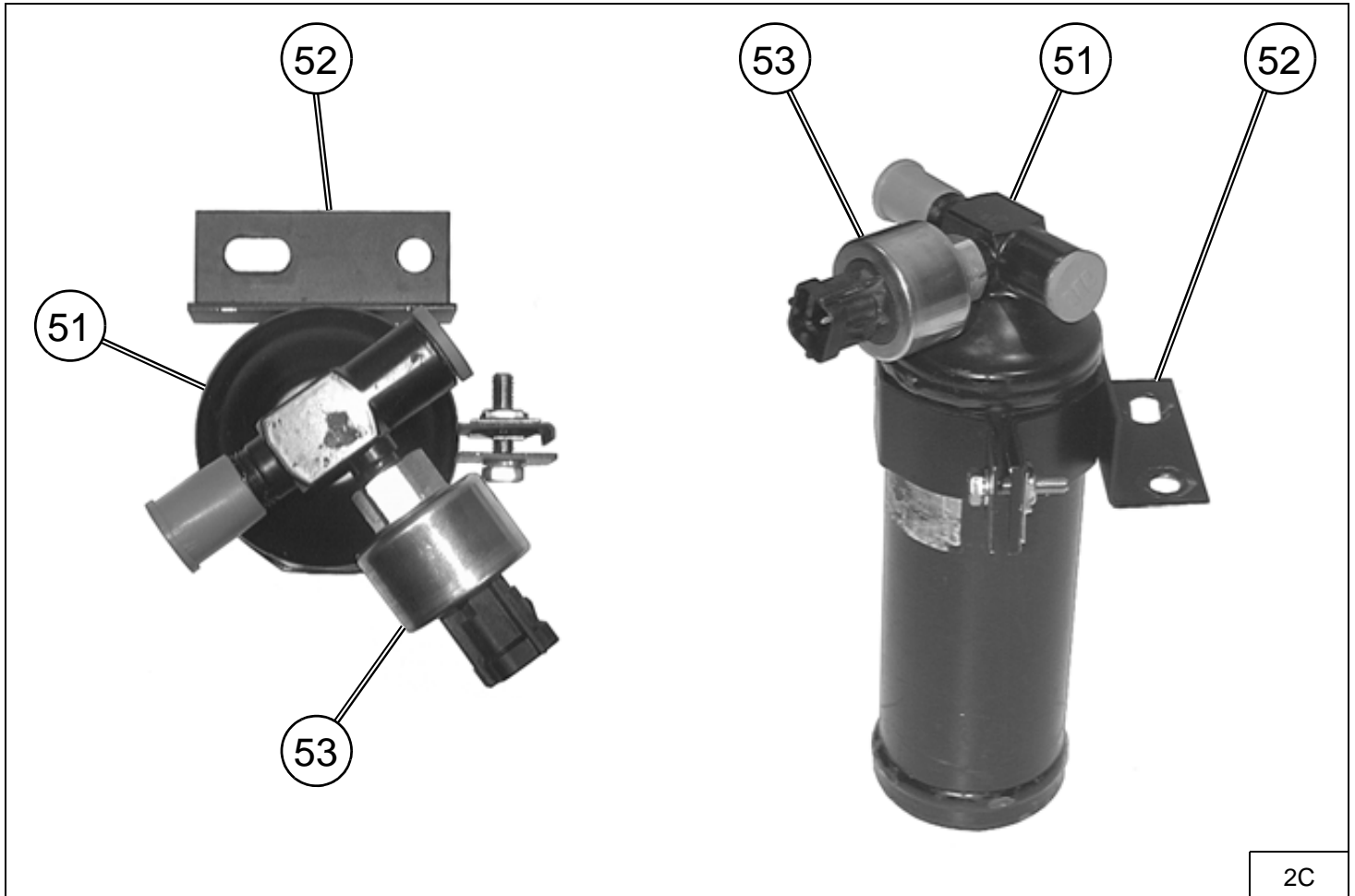

3C

ELEMENTI DI FISSAGGIO / PIECES DE FIXATION FIXING PARTS / BEFESTIGUNGSELEMENTE ELEMENTOS DE FIJACION		
Pos.	Tipologia / Typologie Typology / Tipologie Tipologia	Descrizione / Description Description / Beschreibung Descripción
52.1		M8 x 20
52.2		φ8

**MONTAGGIO COMPONENTI A.C. NELL'ABITACOLO (parte evaporante-comandi)**  
**POSE DES COMPOSANTS A.C. DANS L'HABITACLE (évaporateur-commandes)**  
**A.C. COMPONENTS ASSEMBLY IN THE PASSENGER COMPARTMENT (evaporator-controls)**  
**EINBAU DER KLIMAANLAGEN-BESTANDTEILE IM WAGENINNEREN (Seite der Verdampfersteuerung)**  
**MONTAJE COMPONENTES A.C. EN EL HABITACULO (parte evaporador-mandos)**

MATERIALE FORNITO / MATERIEL FOURNI / SUPPLIED MATERIAL / GELIEFERTES MATERIAL / MATERIAL ABASTECIDO

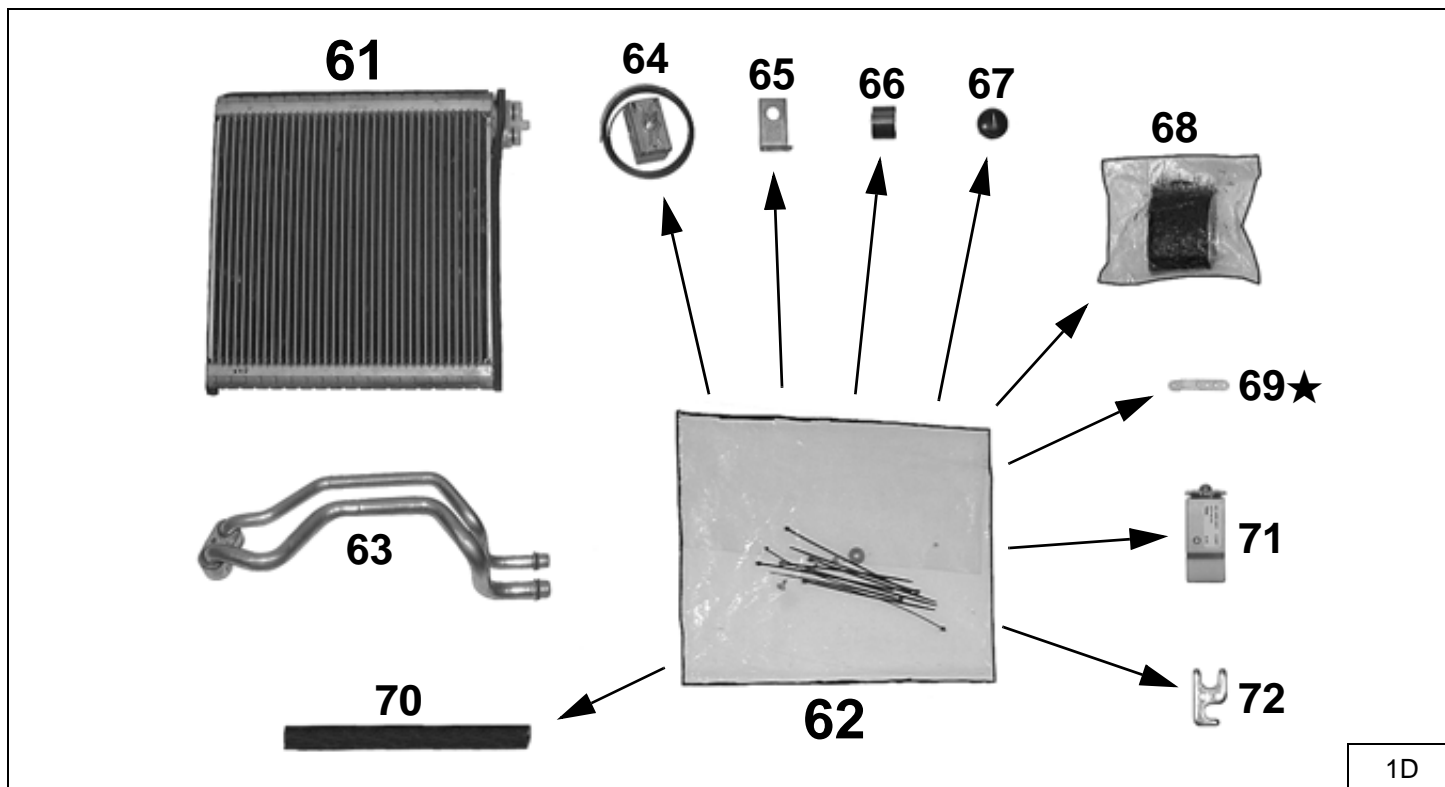

★ = Da non utilizzare nella presente installazione / A ne pas utiliser dans cette installation  
 Not to be used in this installation / Nicht folgeden Einbau zu verwenden  
 No hay que usar en la presente instalación

Pos.	Descrizione / Description Description / Beschreibung Descripción	Codice / Code Kode / Código
61	Batteria evaporante	052803/0
62	Sacchetto accessori	029932/0
63	Distributore tubi gas	043357/0
64	Termostato	0682887/1
65	Staffa supporto termostato	068165/0
66	Molla fissaggio bulbo	069180/0

Pos.	Descrizione / Description Description / Beschreibung Descripción	Codice / Code Kode / Código
67	Pomello	068003/0
68	Mastice anticondensa	070001/0
69★	Fascetta LOOPING	069100/0
70	Tubo scarico condensa	011003.1
71	Valvola di espansione	058051/0
72	Flangia fissaggio valvola	043060/1

MATERIALE FORNITO / MATERIEL FOURNI / SUPPLIED MATERIAL / GELIEFERTES MATERIAL / MATERIAL ABASTECIDO

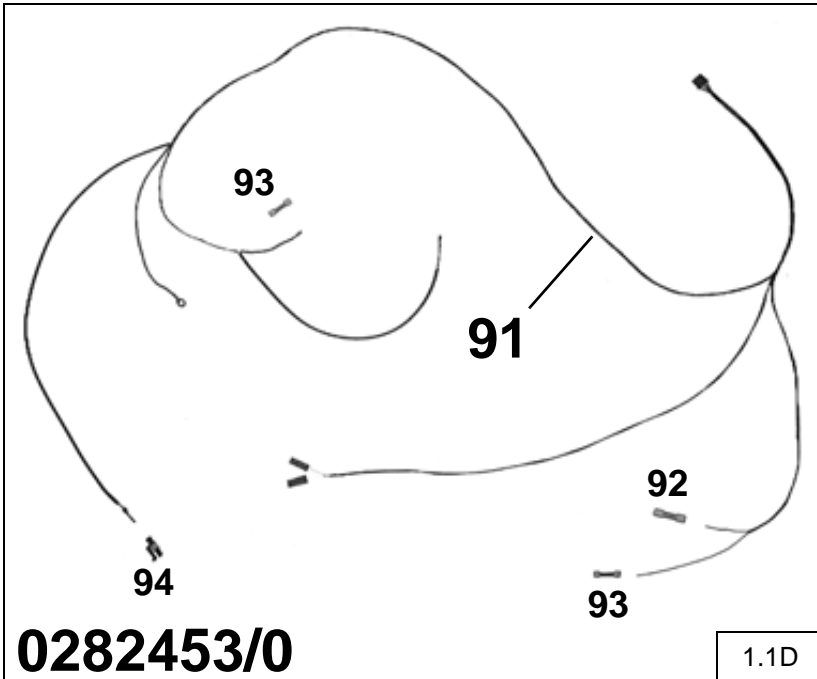

Pos.	Descrizione / Description Description / Beschreibung Descripción	Codice / Code Kode /Codigo
91	Impianto elettrico comandi	0282453/0
92	Giunzione RAYCHEM BLU	064273/0
93	Giunzione RAYCHEM ROSSA	064274/0
94	Connettore PACKARD 1 via	-

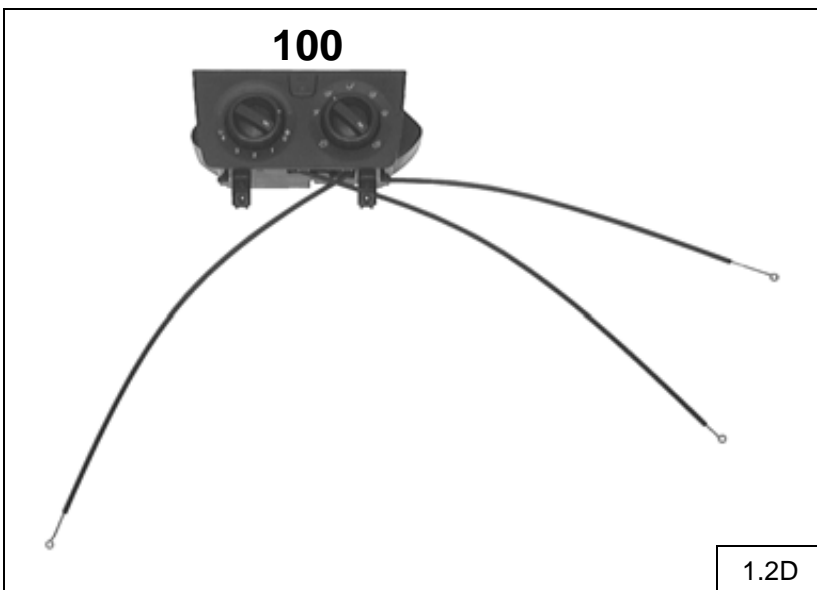

Pos.	Descrizione / Description Description / Beschreibung Descripción	Codice / Code Kode /Codigo
100	Mascherina comandi	0682771/0



OPERAZIONI PRELIMINARI / OPERATIONS PRELIMINAIRES / PRELIMINARY OPERATIONS  
 VORBEREITUNGSARBEITEN / OPERACIONES PRELIMINARES

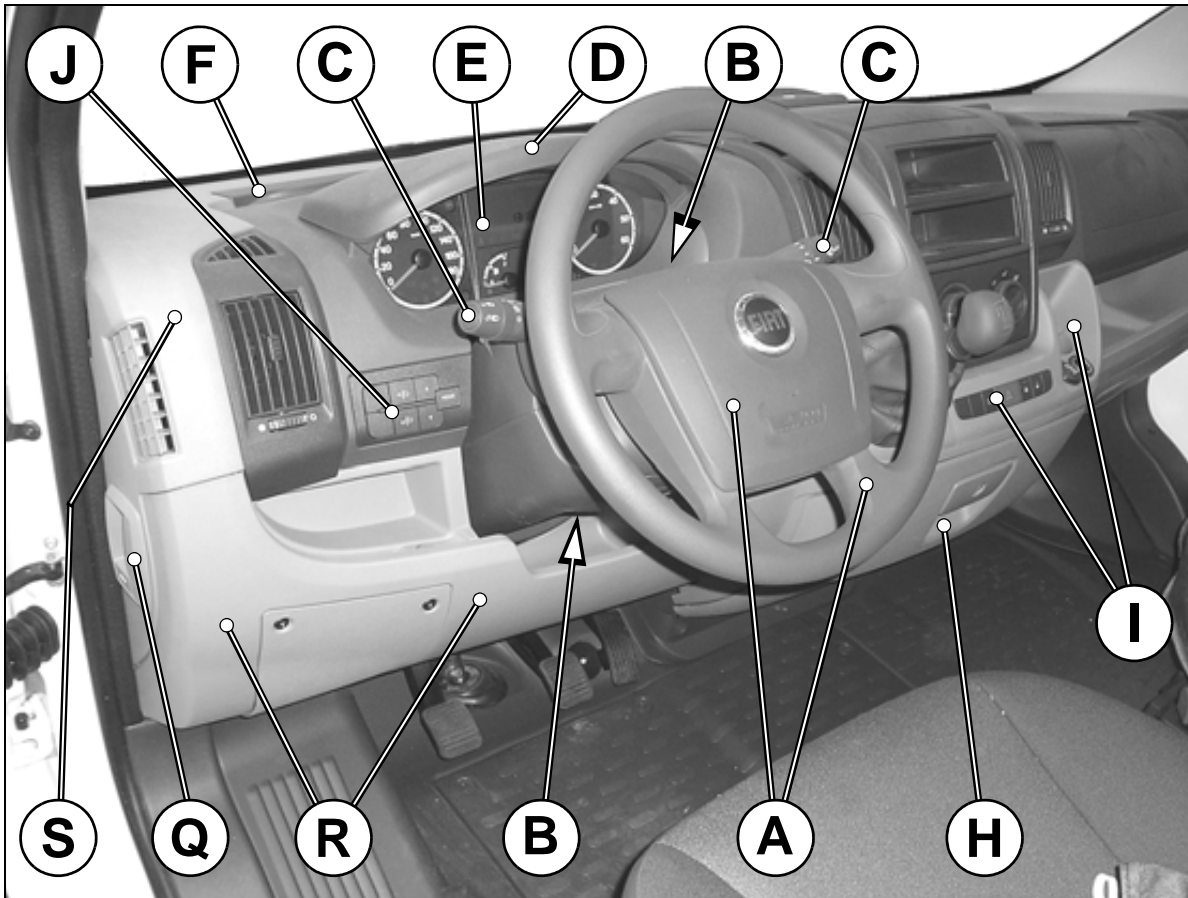

2D

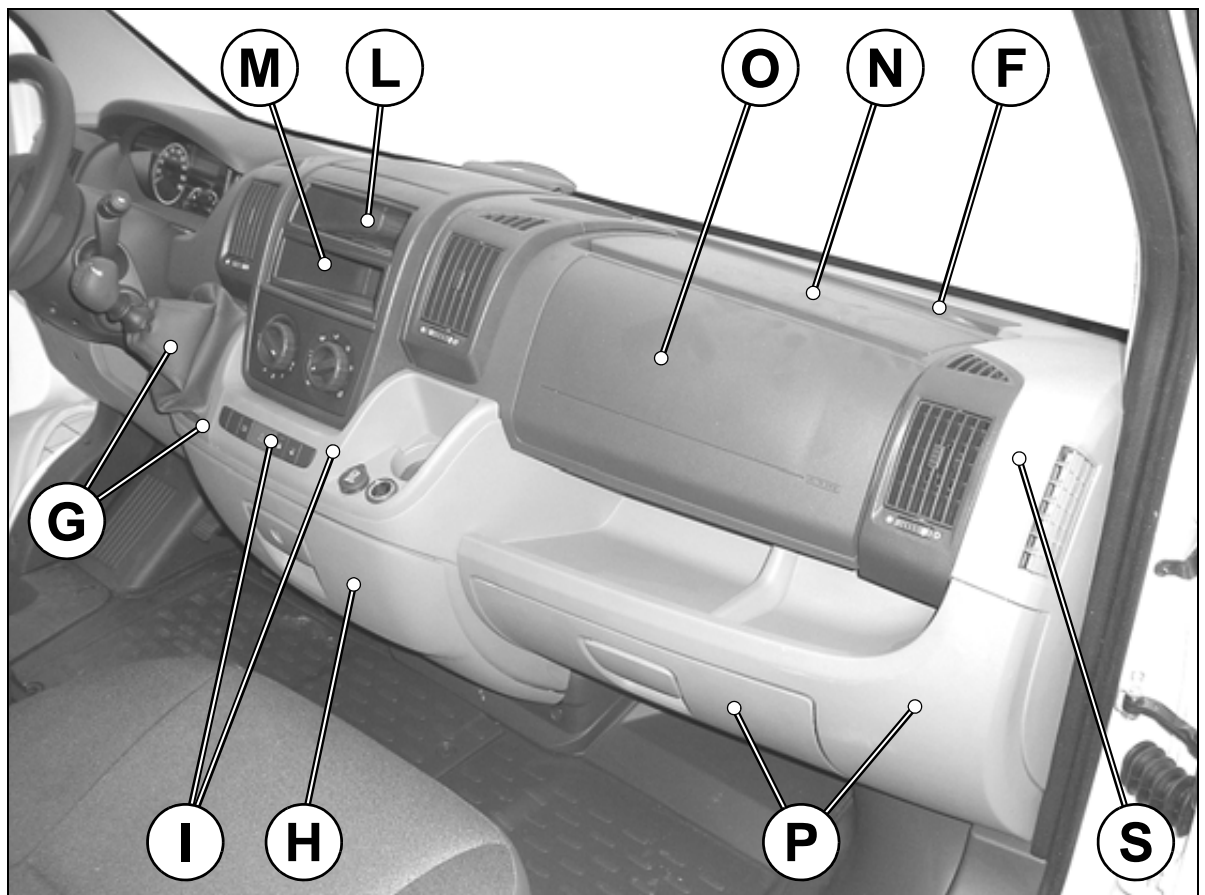

FIG. 2D

(I)

**SMONTARE NELL'ABITACOLO:**

**A)** AIR-BAG e volante (mantenere dritto il volante e bloccare l'anello di connessione con nastro adesivo); **B)** Copripiantone inferiore e superiore dello sterzo; **C)** Gruppo leveraggi di comando luci e tergicristalli; **D)** Cornice quadro strumentazione; **E)** Quadro strumentazione; **F)** Cornice defrost; **G)** Cornice e cuffia leva cambio; **H)** Vano porta-oggetti; **I)** Cornice centrale e gruppo interruttori di servizio; **J)** Gruppo interruttori di servizio; **L)** Vano porta-oggetti; **M)** Autoradio (se presente) e relativa cornice o vano di predisposizione; **N)** Vano porta-oggetti; **O)** AIR-BAG lato passeggero (se presente); **P)** Cornice e cassetto porta-oggetti; **Q)** Leva apertura cofano motore; **R)** Pannello sottopancia lato guida; **S)** Cruscotto scollegando tutti i collegamenti elettrici; **T)** Leva cambio; **U)** Barra trasversale, rimuovendo i fissaggi del piantone sterzo; **V)** Scollegare su lato vano motore i tubi acqua collegati al gruppo riscaldamento; **Z)** Gruppo riscaldamento.

(F)

**DEPOSER DANS L'HABITACLE :**

**A)** AIR-BAG et volant (maintenir le volant droit et fixer l'anneau de connexion à l'aide de ruban adhésif); **B)** Couvercle de colonne de direction inférieure et supérieure; **C)** Groupe leviers de commandes feux et essuie-glaces; **D)** Cadre tableau de bord; **E)** Tableau de bord; **F)** Cadre defrost; **G)** Cadre et protection pour levier de changement de vitesse; **H)** Compartiment vide-poche; **I)** Cadre central et groupe interrupteurs de service; **J)** Groupe interrupteurs de service; **L)** Compartiment vide-poche; **M)** Autoradio e cadre correspondant ou compartiment prévu; **N)** Compartiment vide-poche; **O)** AIR-BAG côté passager; **P)** Cadre et boîte à gants; **Q)** Levier d'ouverture du capot moteur; **R)** Panneau sous le tableau de bord côté conduite; **S)** Tableau de bord en déconnectant tous les branchements électriques; **T)** Levier de changement de vitesse; **U)** Barre transversale en éliminant les pièces de fixation colonne de direction; **V)** Déconnecter sur le côté compartiment moteur les tuyaux de l'eau connectés au groupe chauffage; **Z)** Groupe chauffage.

(GB)

**REMOVE IN THE PASSENGER COMPARTMENT :**

**A)** AIR-BAG and steering wheel (keep the steering wheel straight and tape down the connection ring); **B)** Upper and lower steering column casing; **C)** Light and windshield wiper control lever assembly; **D)** Instrument panel frame; **E)** Instrument panel; **F)** Defrost frame; **G)** Frame and gear lever guard; **H)** Glove compartment; **I)** Central frame and service switch assembly; **J)** Service switch assembly; **L)** Glove compartment; **M)** Radio (if there is one) and frame or arranged radio housing space; **N)** Glove compartment; **O)** Passenger side AIR-BAG (if there is one); **P)** Frame and glove box; **Q)** Hood release lever; **R)** Panel under the dashboard on driver's side; **S)** Dashboard disconnecting all electrical wires; **T)** Gear lever; **U)** Transverse bar by removing the steering wheel column fasteners; **V)** Disconnect the water hoses connected to the heating assembly on the side of the engine compartment; **Z)** Heater assembly.

(D)

**VOM FAHRZEUGINNEREN AUSZUBAUEN:**

**A)** AIR-BAG und Lenkrad (Das Lenkrad gerade halten und den Verbindungsring mit Klebeband blockieren); **B)** Untere und obere Lenksäulenabdeckung des Lenkrads; **C)** Bedienungshebel Licht und Scheibenwischer; **D)** Instrumententafelrahmen; **E)** Instrumententafel; **F)** Defrostrahmen; **G)** Rahmen und Ganghebelabdeckung; **H)** Handschuhkastens; **I)** Enbrettrahmen und des Bedienungsschalteinheit; **J)** Bedienungsschalteinheit; **L)** Handschuhkastens; **M)** Autoradio (wo vorhanden) und entsprechenden Rahmen oder vorgesehenen Raum; **N)** Handschuhkastens; **O)** AIR-BAG (wo vorhanden) Ausschaltungsvorrichtung; **P)** Rahmen und Handschuhkasten; **Q)** Öffnungshebel der Motorhaube; **R)** Abdeckung unter dem Armaturenbrett-Fahrerseite; **S)** Armaturenbrett-alle elektrischen Teile abklemmen; **T)** Gangschaltung; **U)** Querträger, indem die Befestigungen der Lenksäule gelöst werden; **V)** Die an Heizgerät angeschlossenen Wasser-schläuche an der Motorraumseite abklemmen; **Z)** Heizgeräteinheit.

(E)

**DESMONTAR EL EN HABITÁCULO:**

**A)** AIR-BAG y volante (tener el volante en posición recta y bloquear el anillo de conexión con tira adhesiva); **B)** Cubre columna inferior y superior del volante; **C)** Grupo del mecanismo de palancas de mando luces y limpiaparabrisas; **D)** Marco tablero de instrumentos; **E)** Tablero de instrumentos; **F)** Marco defrost; **G)** Marco y funda palanca de cambio; **H)** Espacio guantera; **I)** Marco central y grupo interruptores de servicio; **J)** grupo interruptores de servicio; **L)** Espacio guantera; **M)** Radioreceptor (si presente) y correspondiente marco o espacio de predisposición; **N)** Espacio guantera; **O)** AIR-BAG lado pasajero (si presente); **P)** Marco y cajón guantera; **Q)** Palanca apertura capot motor; **R)** Panel bajo placa lado del conductor; **S)** Tablero desconectando todas las conexiones eléctricas; **T)** Palanca de cambio velocidades; **U)** Barra transversal, eliminado las fijaciones de la columna de la dirección; **V)** Desconectar en el espacio motor los tubos agua conectados al grupo calefacción; **Z)** Grupo calefacción.



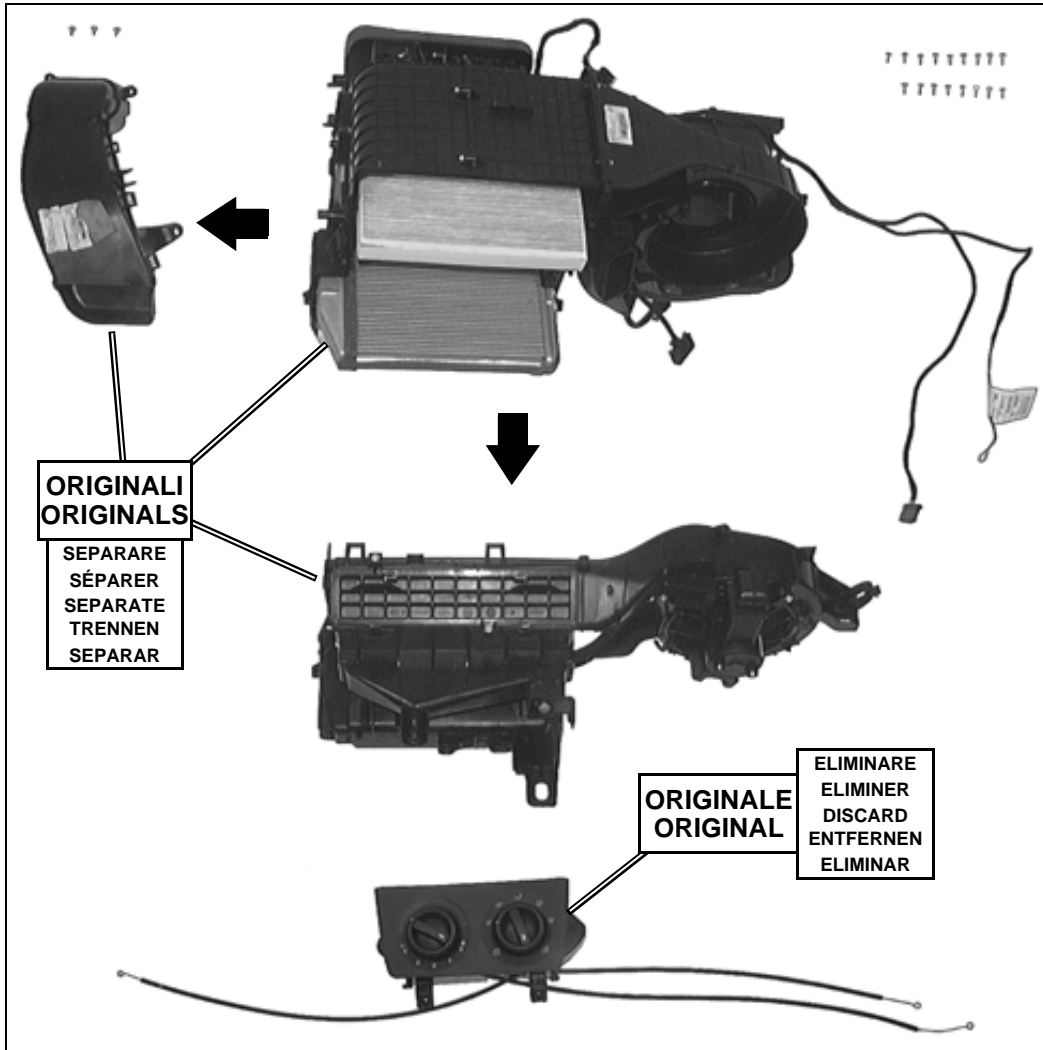

3D

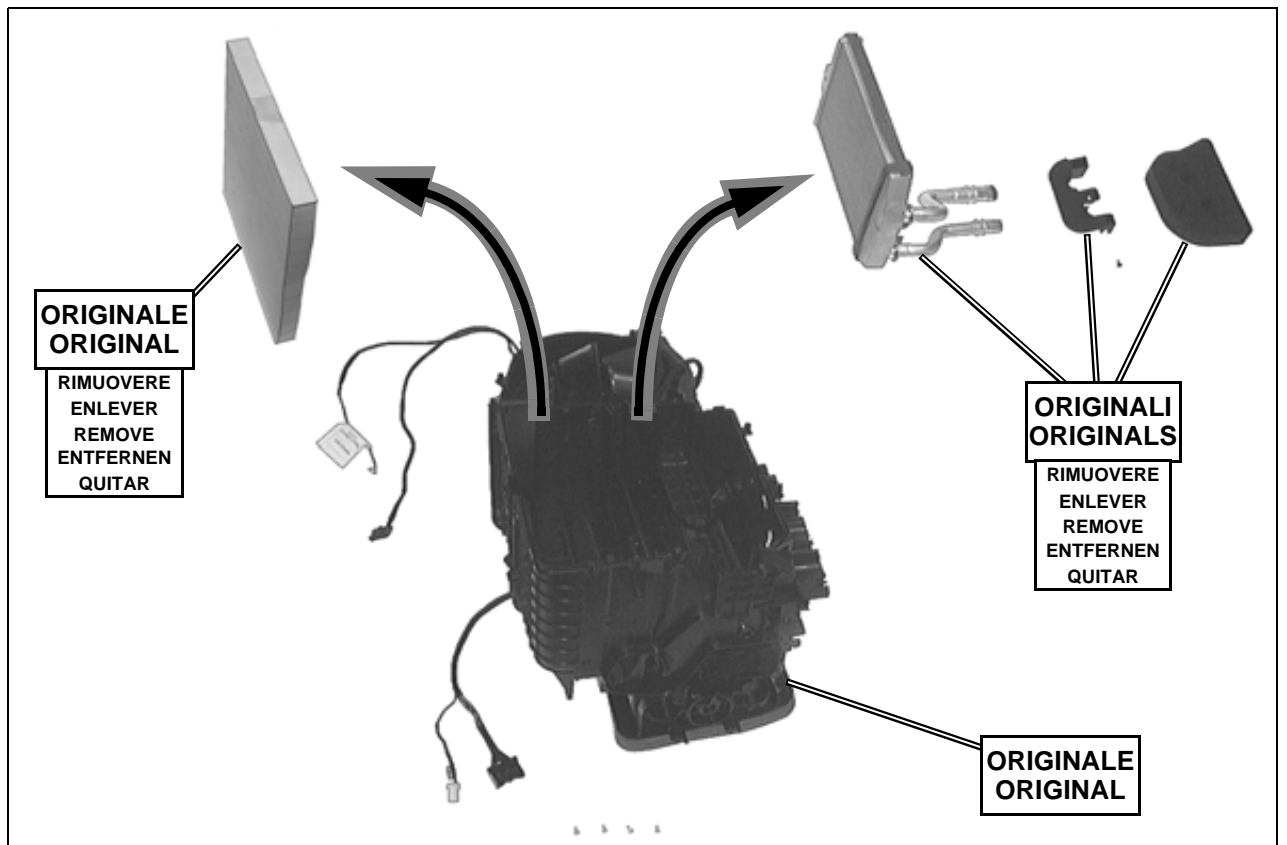

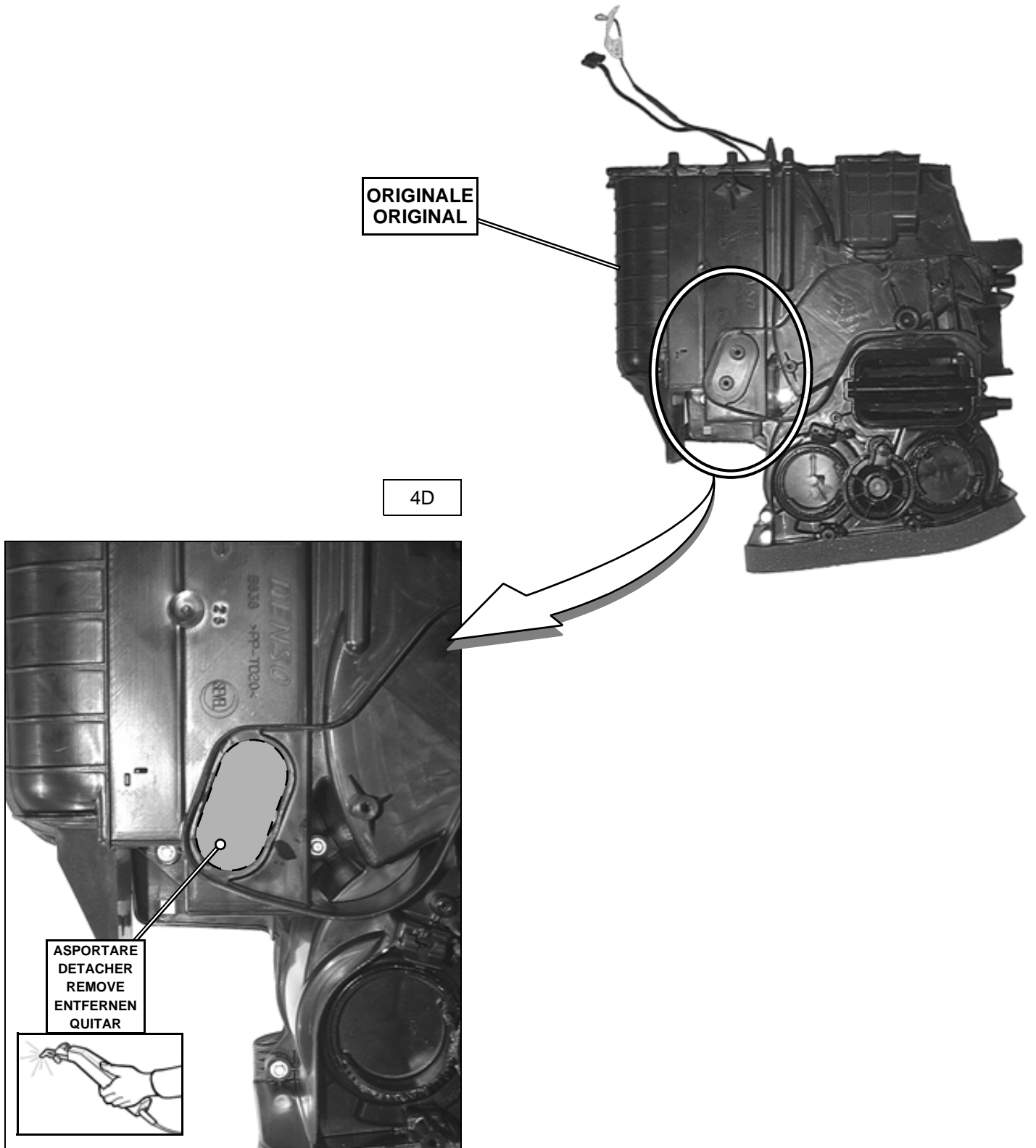

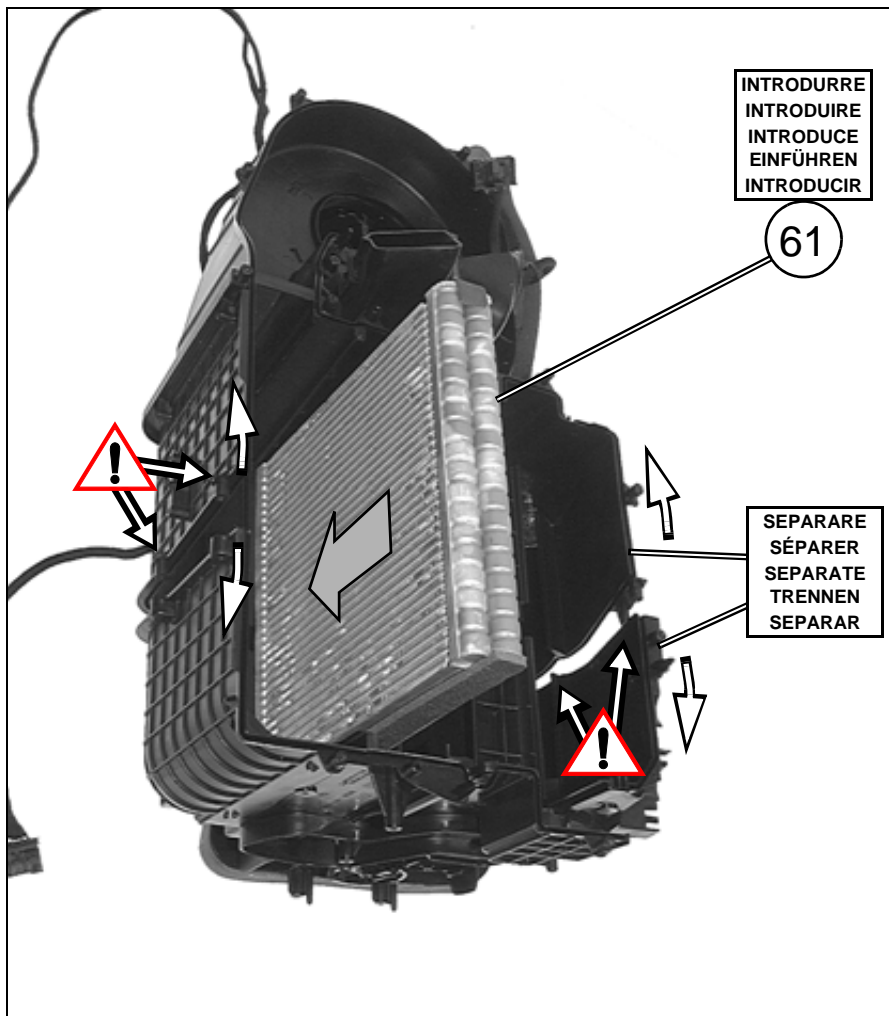

INTRODURRE  
INTRODUIRE  
INTRODUCE  
EINFÜHREN  
INTRODUCIR

61

SEPARARE  
SÉPARER  
SEPARATE  
TRENNEN  
SEPARAR

5D



(I)  
**ATTENZIONE:** per facilitare l'introduzione della batteria evaporante "61" all'interno del gruppo riscaldamento, si consiglia di rimuovere momentaneamente i fissaggi dei due semigusci, nei punti indicati in figura.

(F)  
**ATTENTION:** pour faciliter l'introduction de la batterie évaporateur "61" à l'intérieur du groupe chauffage, on conseille d'enlever momentanément les fixations des deux demi-coques, aux points indiqués sur la figure.

(GB)  
**WARNING:** to facilitate inserting the evaporating unit "61" into the heating unit, we suggest you temporarily remove the elements securing the two halves at the points indicated in the figure.

(D)  
**ACHTUNG:** Zur einfacheren Einführung der Verdampferbatterie "61" ins Innere der Heizgerätgruppe ist es ratsam kurzfristig die Befestigungen der beiden Schalenhälften in den in der Abbildung gezeigten Punkten zu entfernen.

(E)  
**ATENCIÓN:** para facilitar la introducción de la batería evaporadora "61" dentro del grupo calefacción, se aconseja quitar momentáneamente las fijaciones de los dos semicascos, por los puntos indicados en la figura.

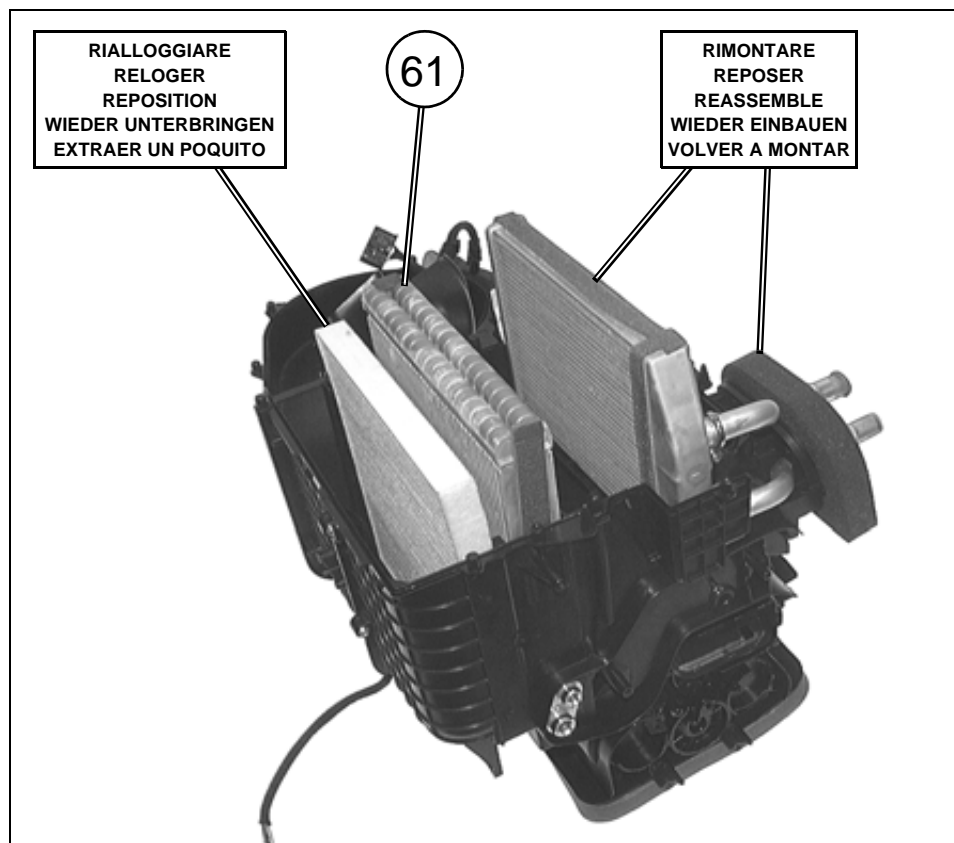

RIALLOGGIARE  
RELOGER  
REPOSITION  
WIEDER UNTERBRINGEN  
EXTRAER UN POQUITO

61

RIMONTARE  
REPOSER  
REASSEMBLE  
WIEDER EINBAUEN  
VOLVER A MONTAR

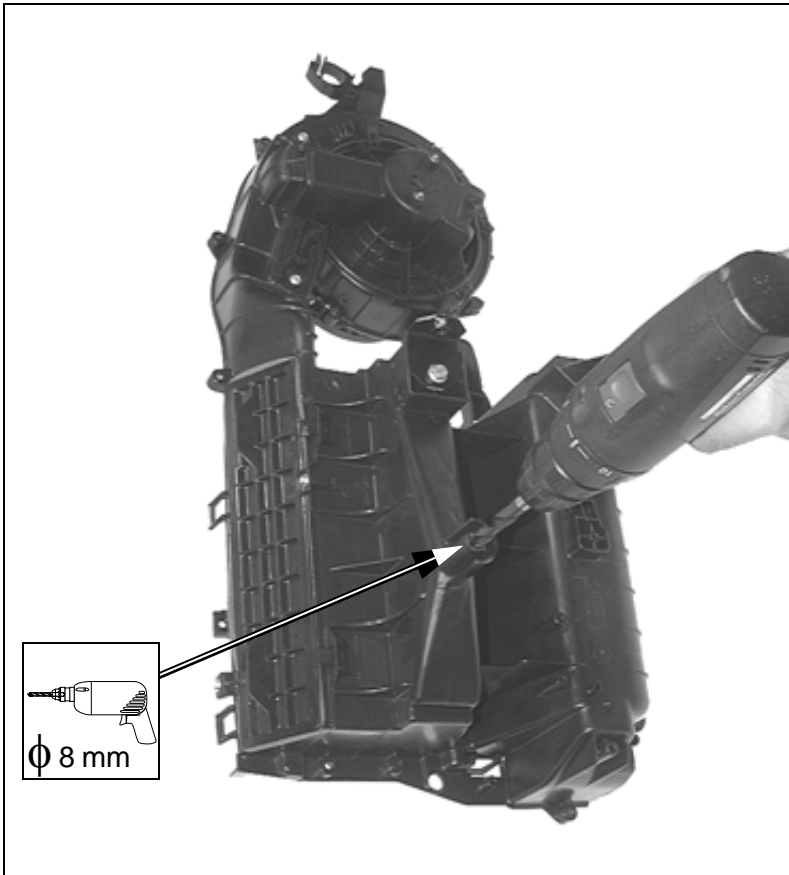

6D

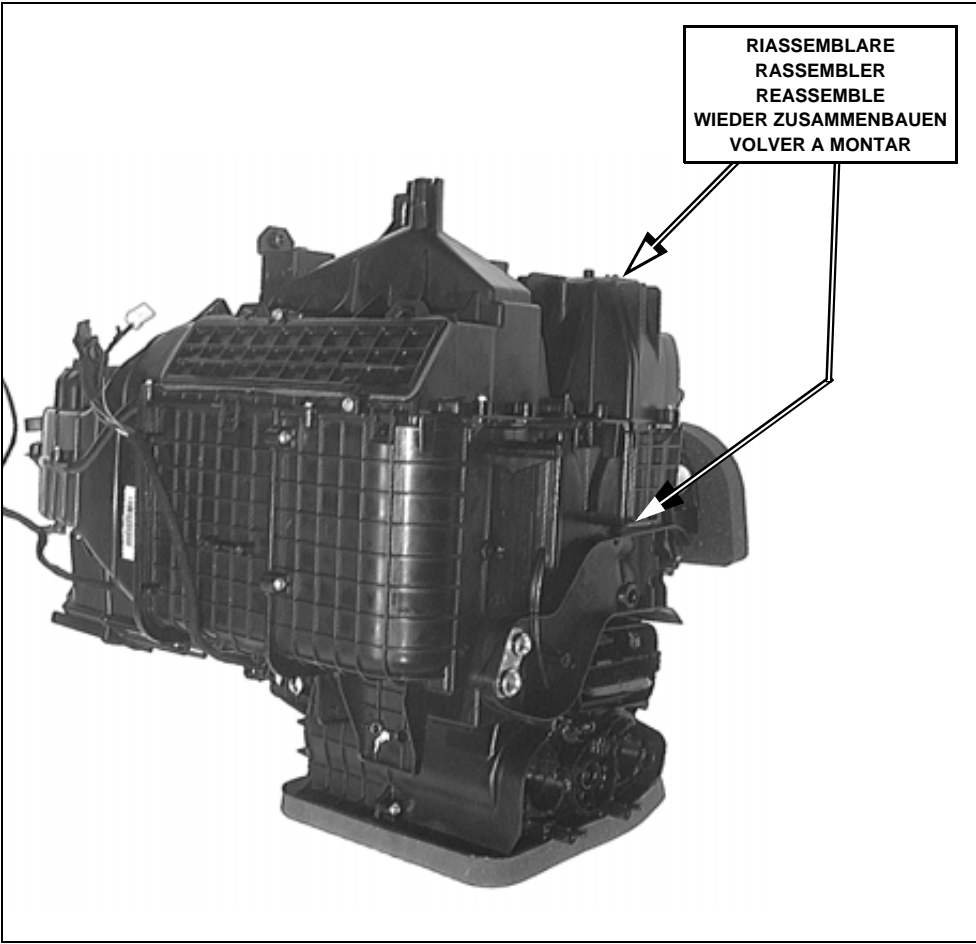

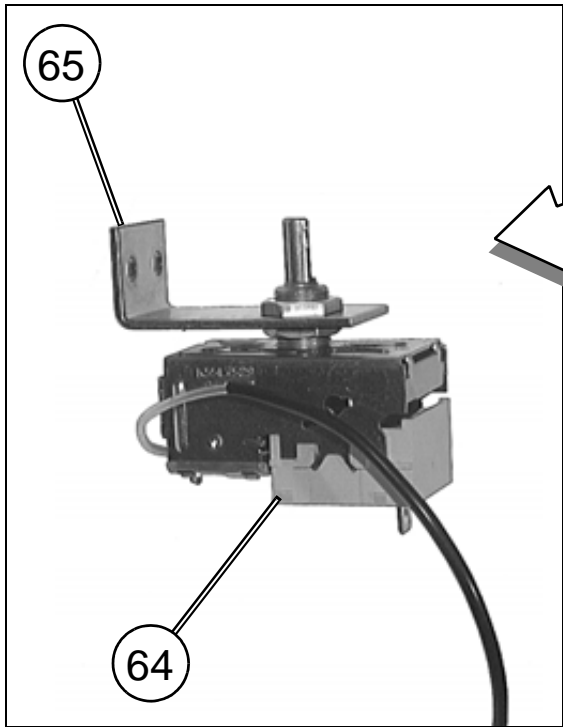

7D

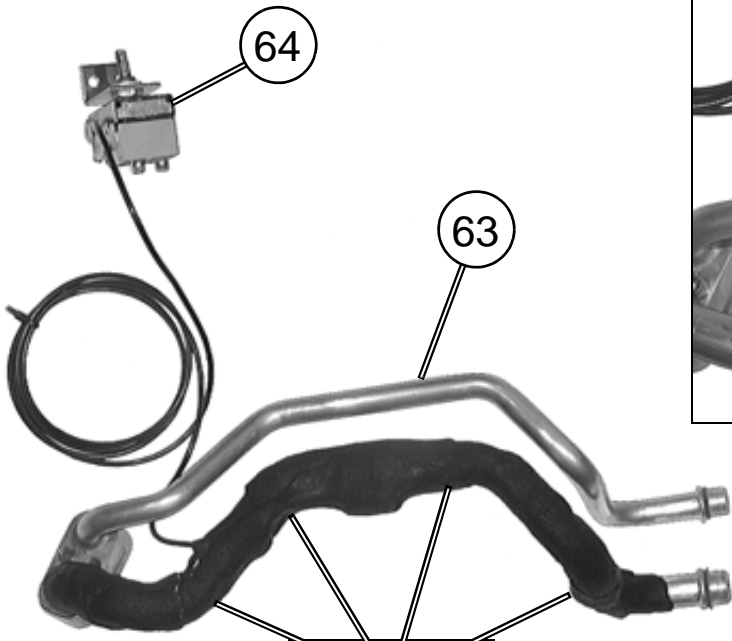
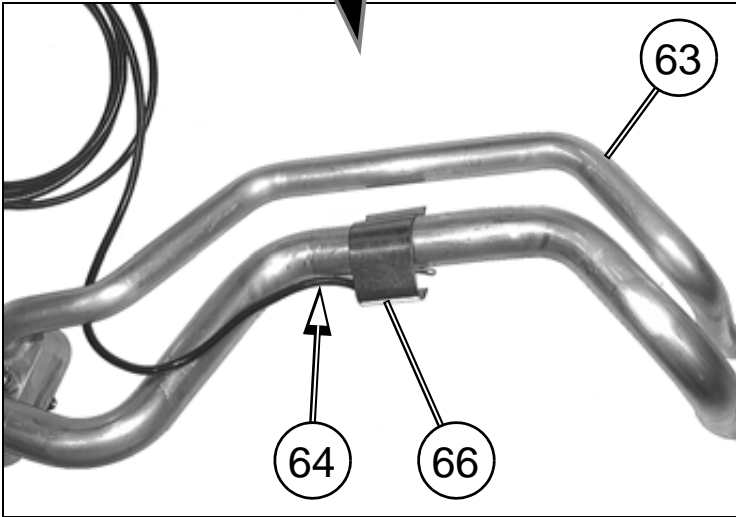
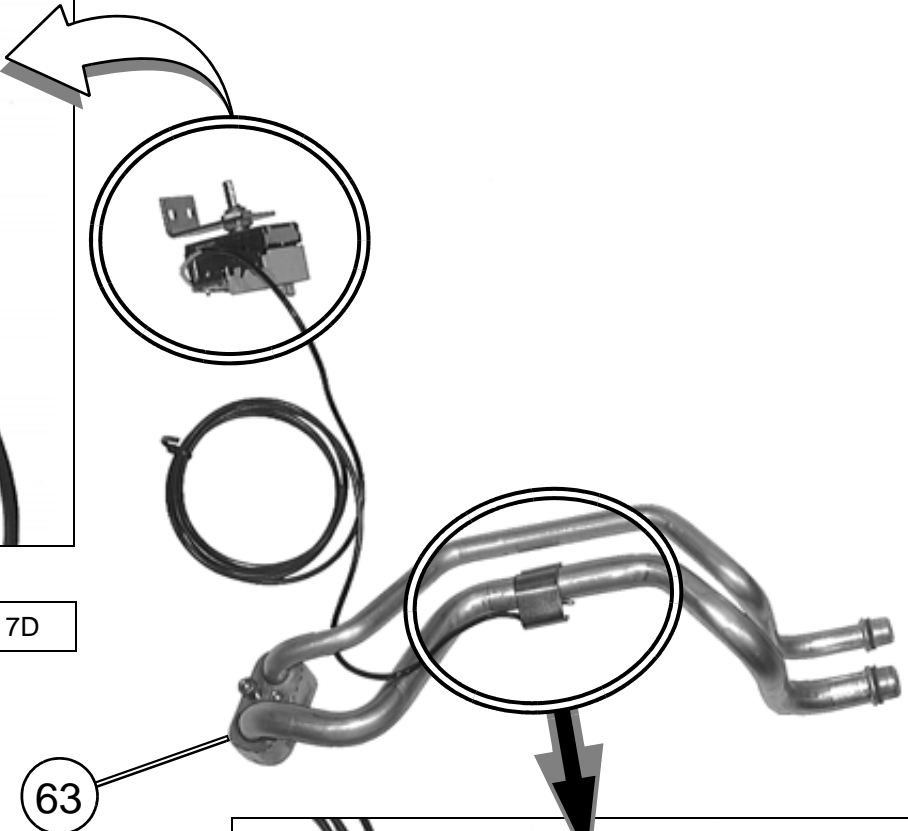

68  
 RIVESTIRE  
 RHABILLER  
 RECLOTHE  
 WIEDER EINKLEIDEN  
 VOLVER A VESTIR



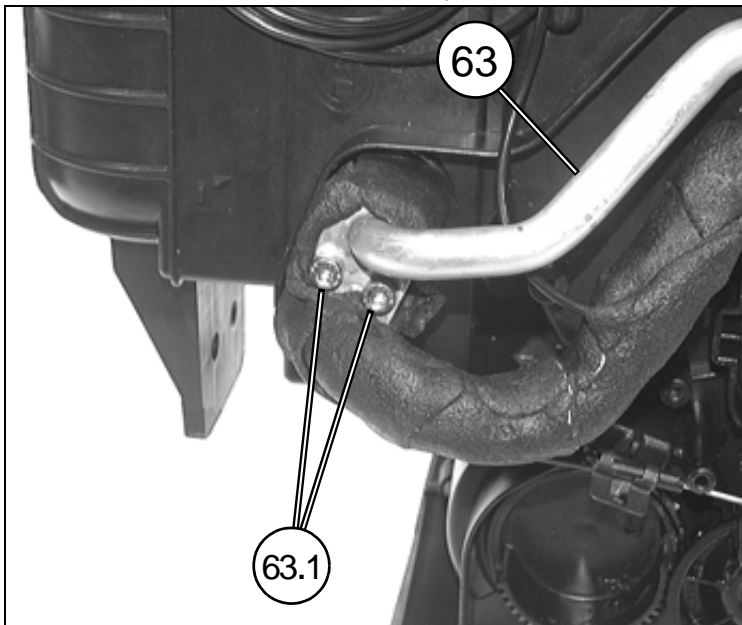
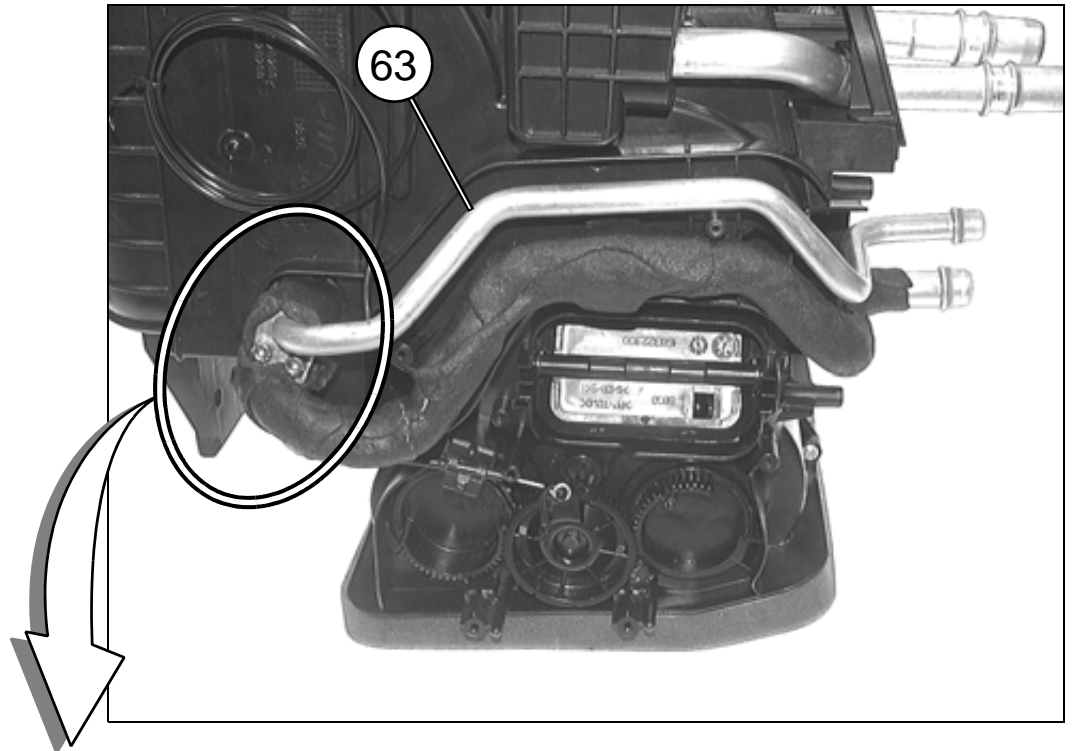

8D

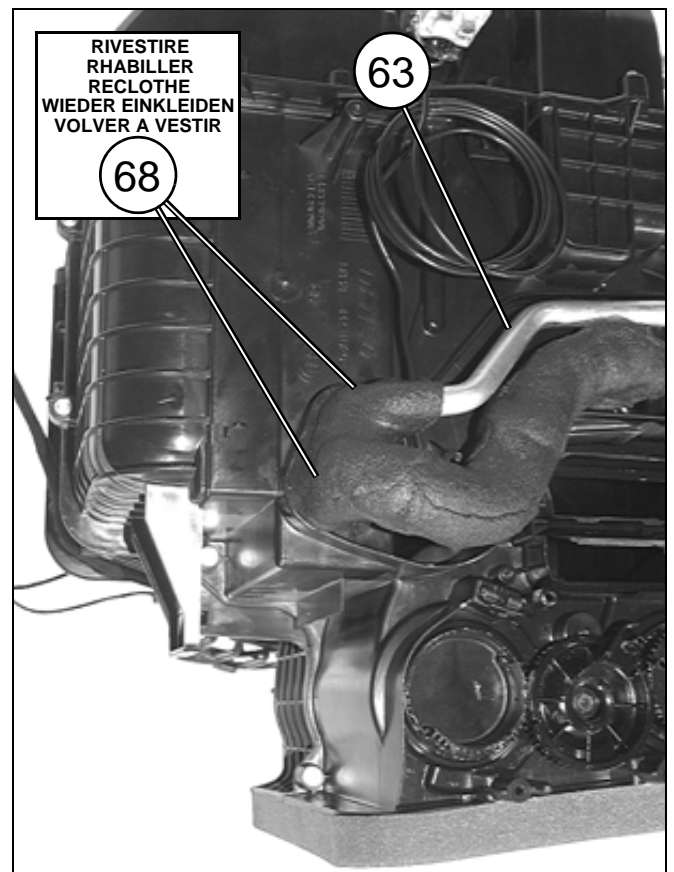

ELEMENTI DI FISSAGGIO PIECES DE FIXATION / FIXING PARTS BEFESTIGUNGSELEMENTE ELEMENTOS DE FIJACION		
Pos.	Tipologia Typologie Typology Tipologie Tipologia	Descrizione Description Description Beschreibung Descripción
63.1		M5 x 30

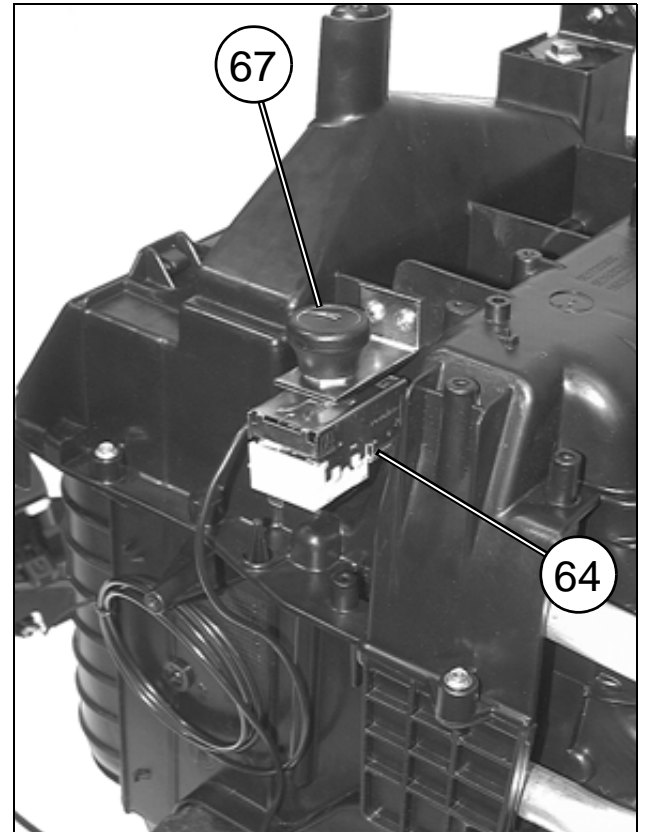
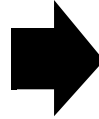
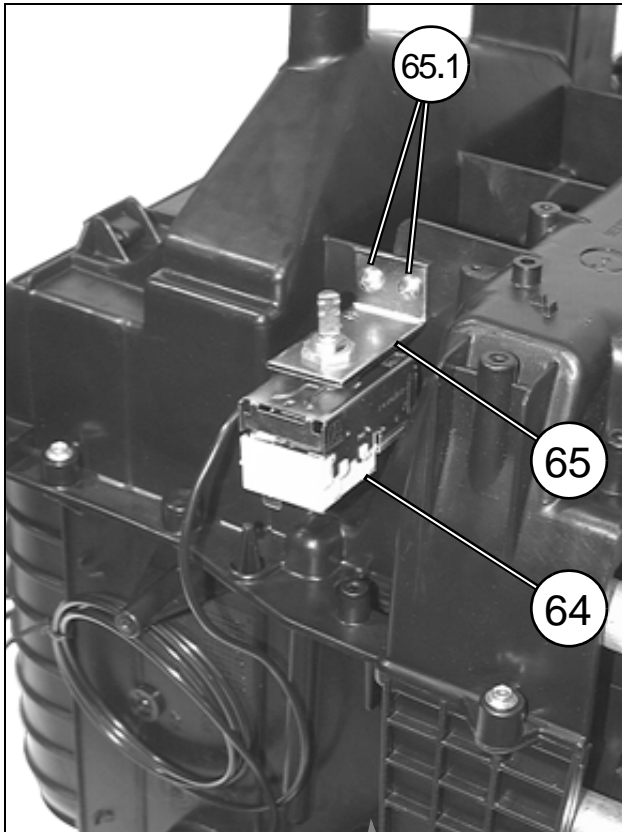

9D

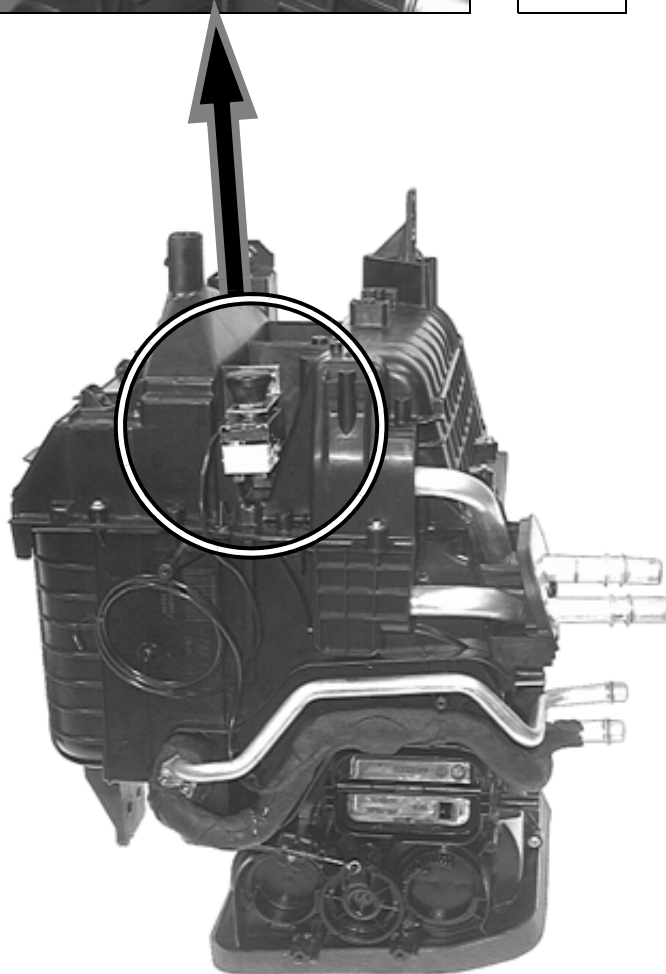

ELEMENTI DI FISSAGGIO PIECES DE FIXATION / FIXING PARTS BEFESTIGUNGSELEMENTE ELEMENTOS DE FIJACION		
Pos.	Tipologia Typologie Typology Tipologie Tipologia	Descrizione Description Description Beschreibung Descripción
65.1		4 x 10

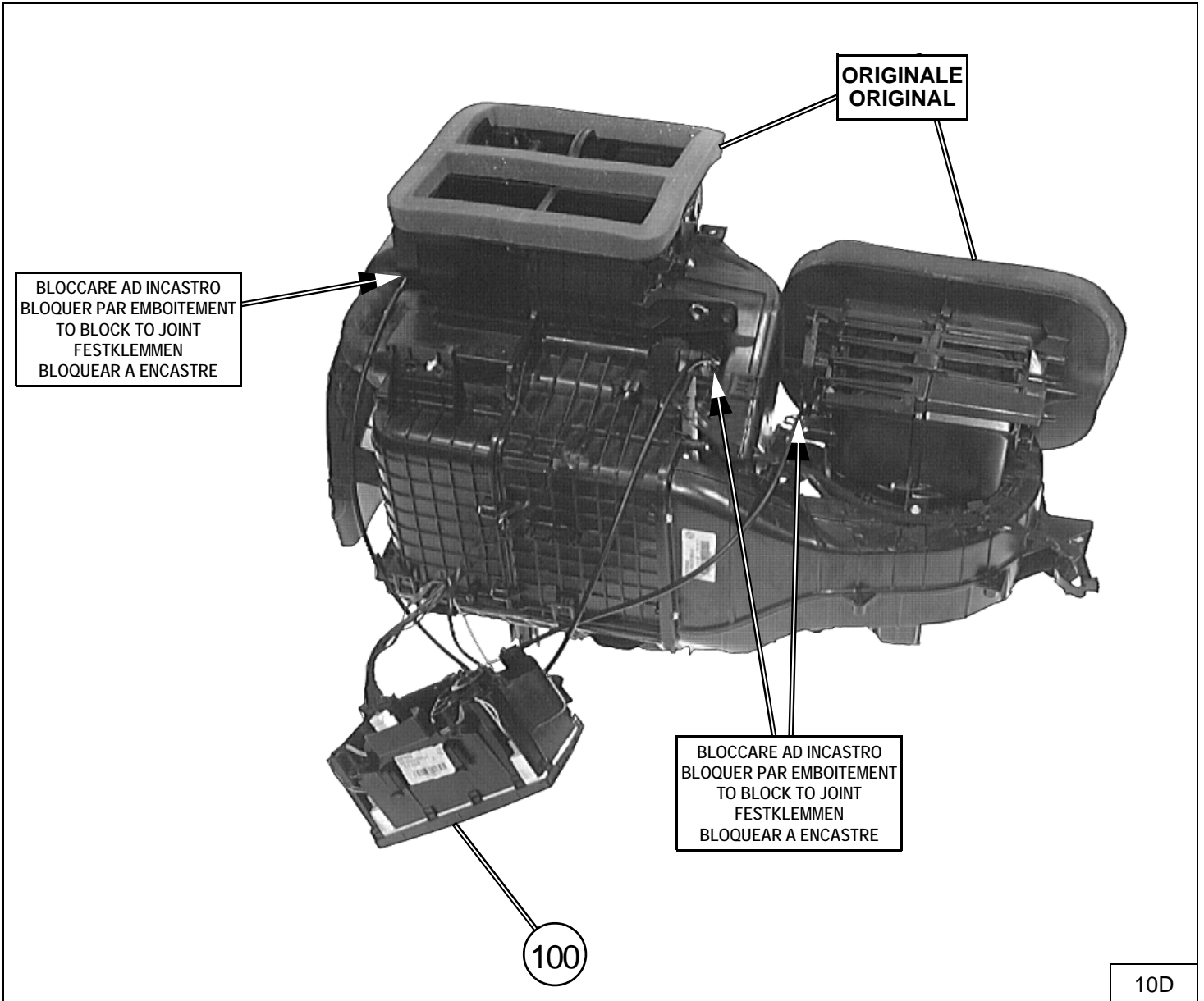



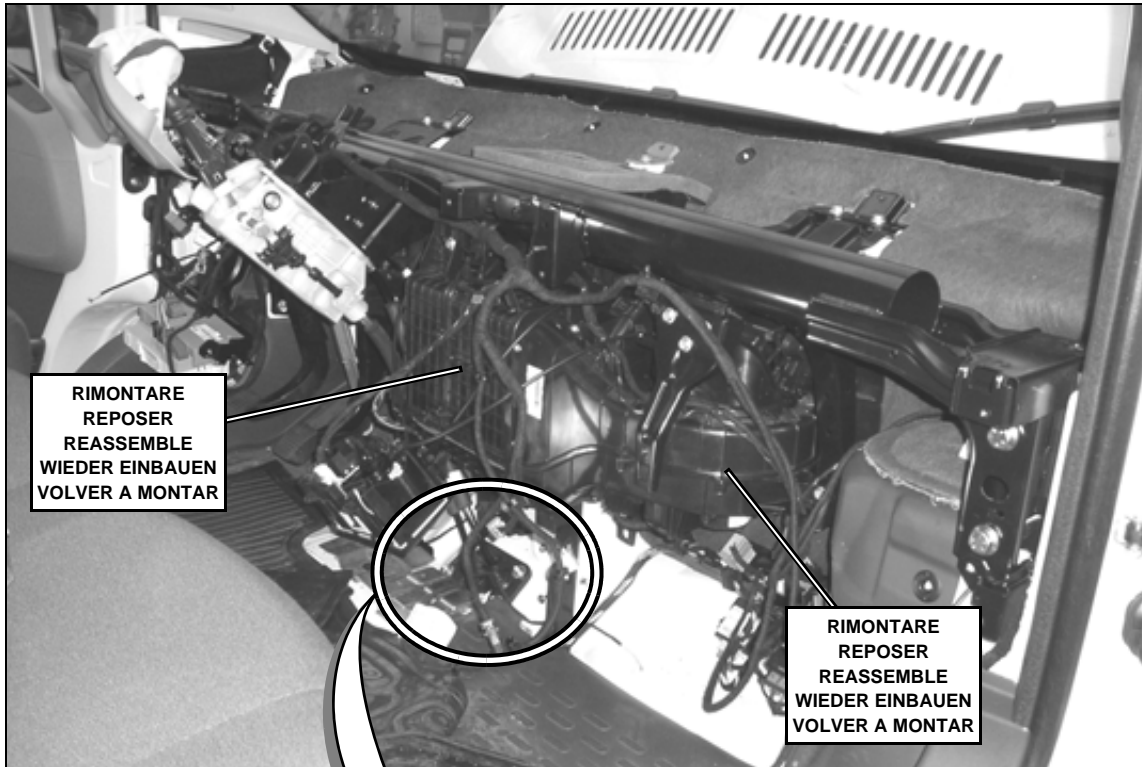

11D

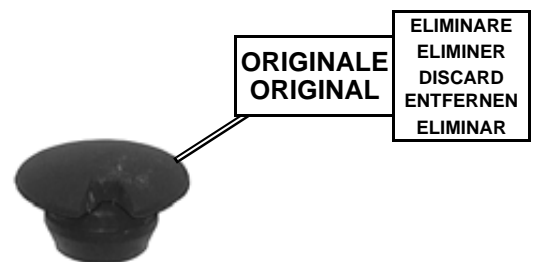
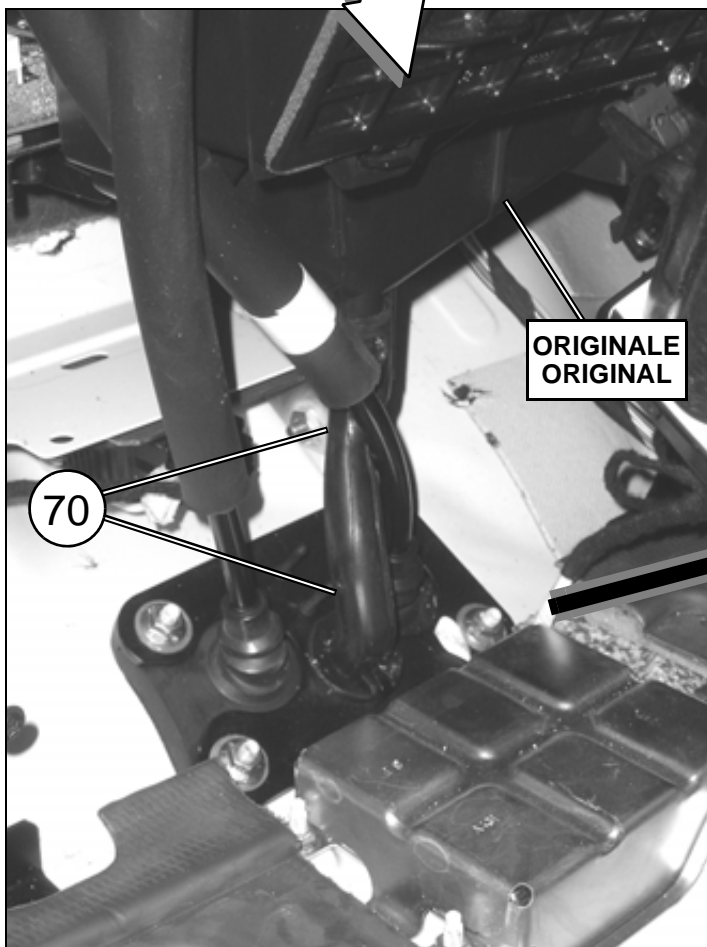

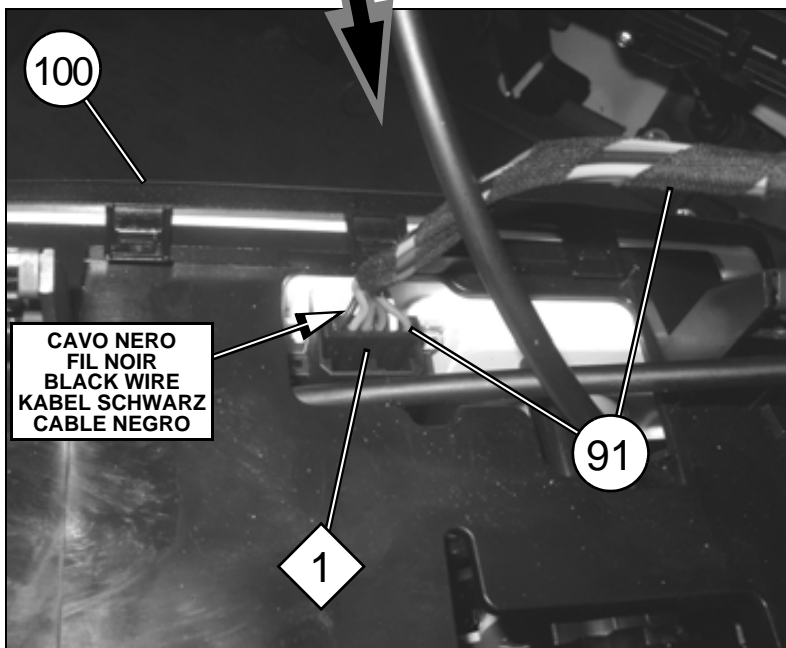
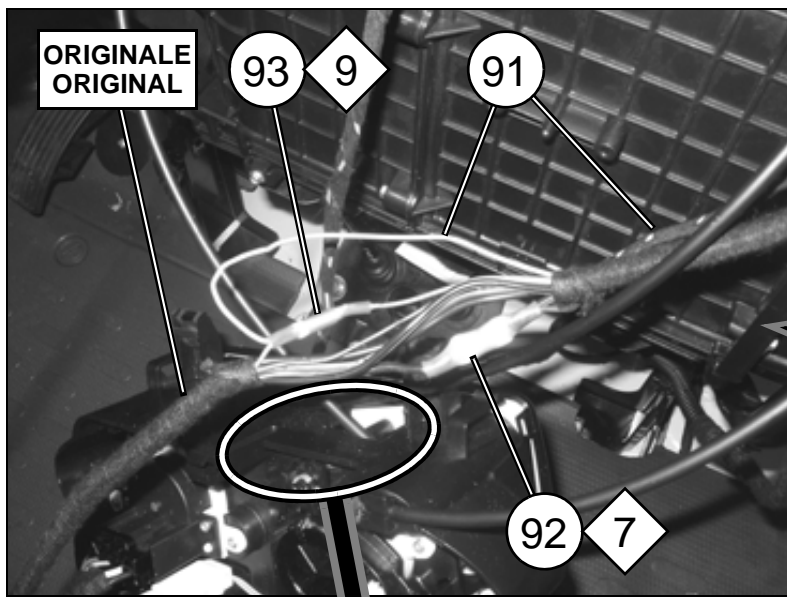
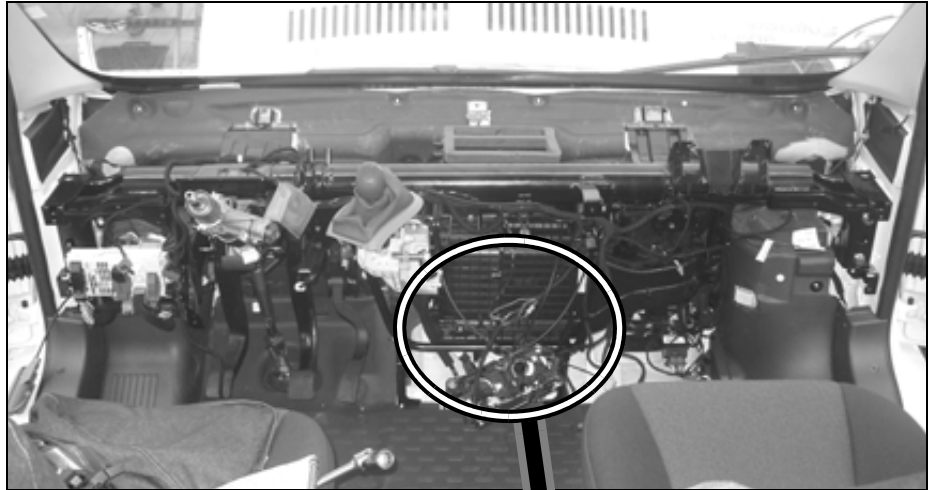



13D

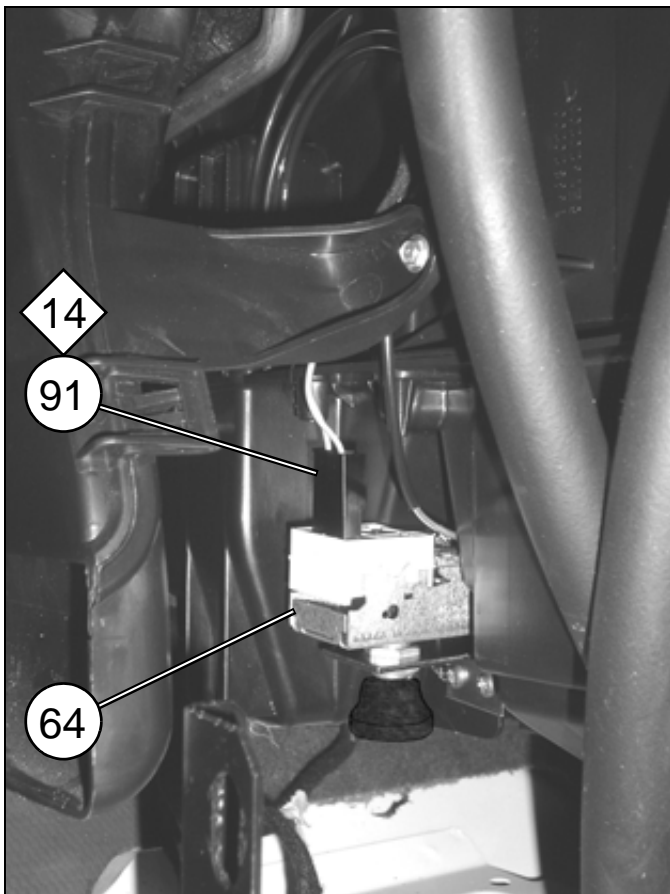



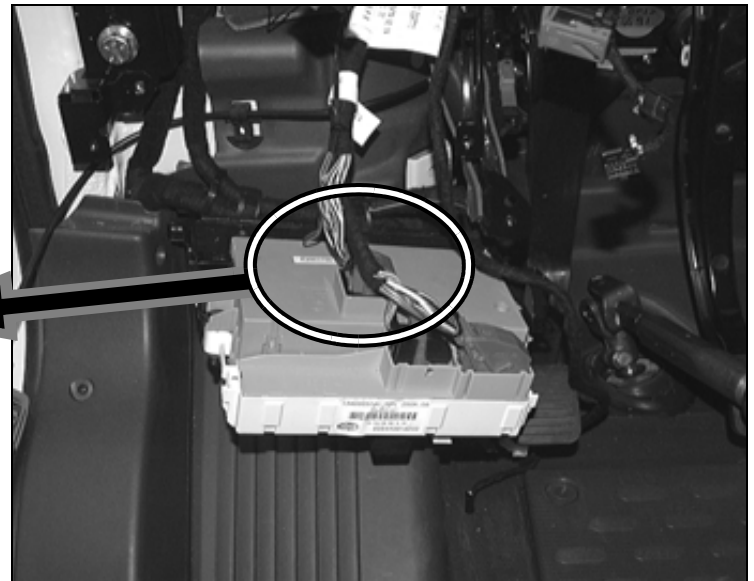
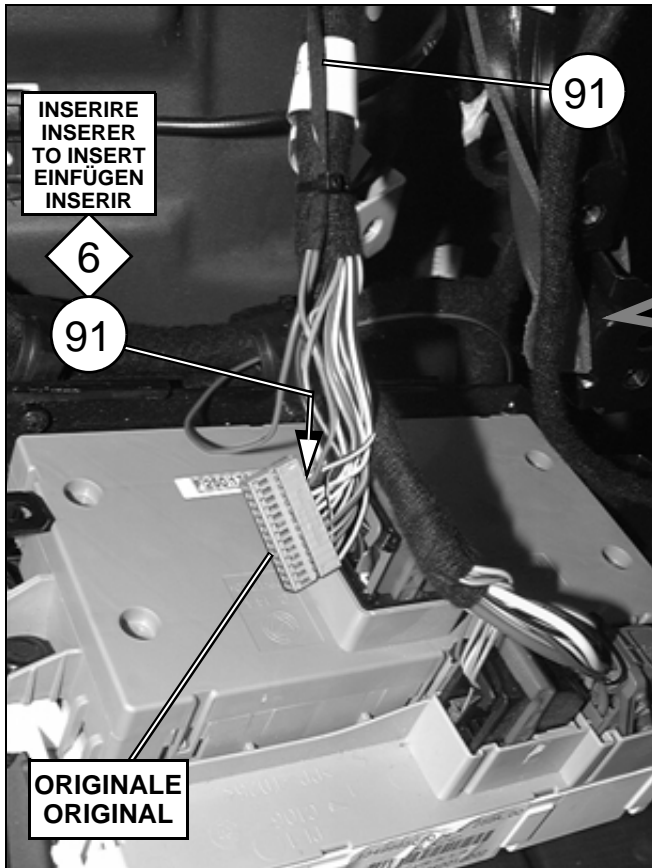

14D

(I) **ATTENZIONE:** nel caso in cui nel connettore originale "6" sia presente il cavo originale alla posizione n° 27, collegare il cavo "BLU-VERDE" dell'impianto elettrico "91" mediante giunzione RAYCHEM "93".

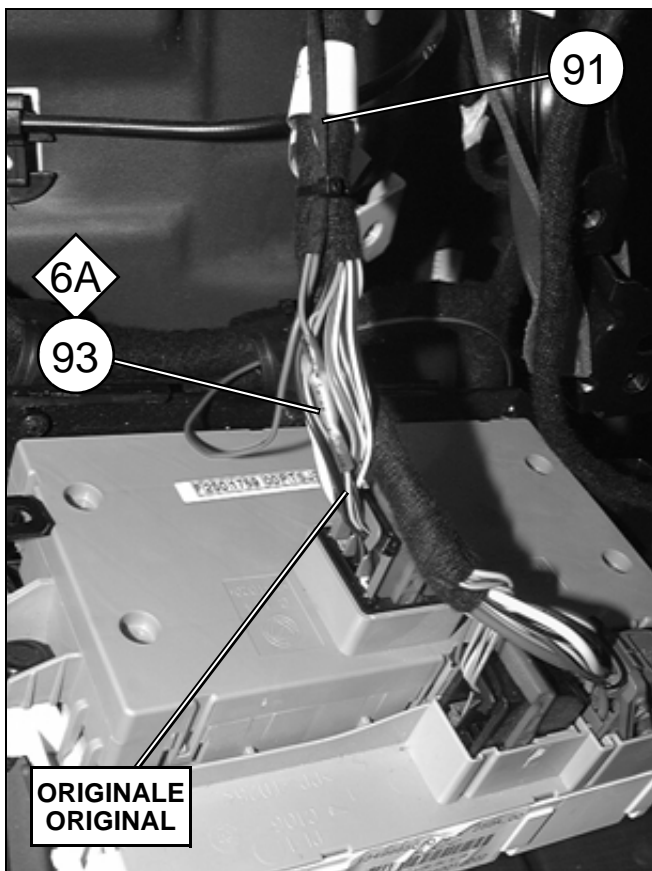

(F) **ATTENTION:** si dans le connecteur d'origine "6" il y a présence du fil d'origine à la position n° 27, connecter le fil "BLEU-VERT" du faisceau électrique "91" à l'aide du raccord RAYCHEM "93".

(GB) **WARNING:** if the original connector "6" has the original wire in position no. 27, hook up the "BLUE-GREEN" wire of the supplied electrical system "91" using the Raychem connector "93".

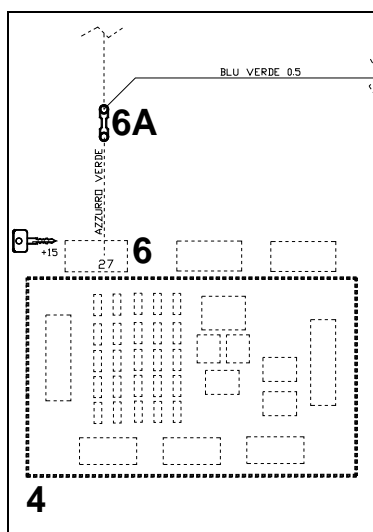

(D) **ACHTUNG:** sollte im Original-Steckverbinder "6" das Original-Kabel an Position Nr.27 sich befinden, Kabel "BLAU-GRÜN" der elektrischen Anlage "91" mit Raychem-Verbindung "93" anschließen

(E) **ATENCIÓN:** en caso de que en el conector original "6" esté presente el cable original en la posición n° 27, conectar el cable "AZUL-VERDE" de la instalación eléctrica "91" a través de junta RAYCHEM "93".



15D

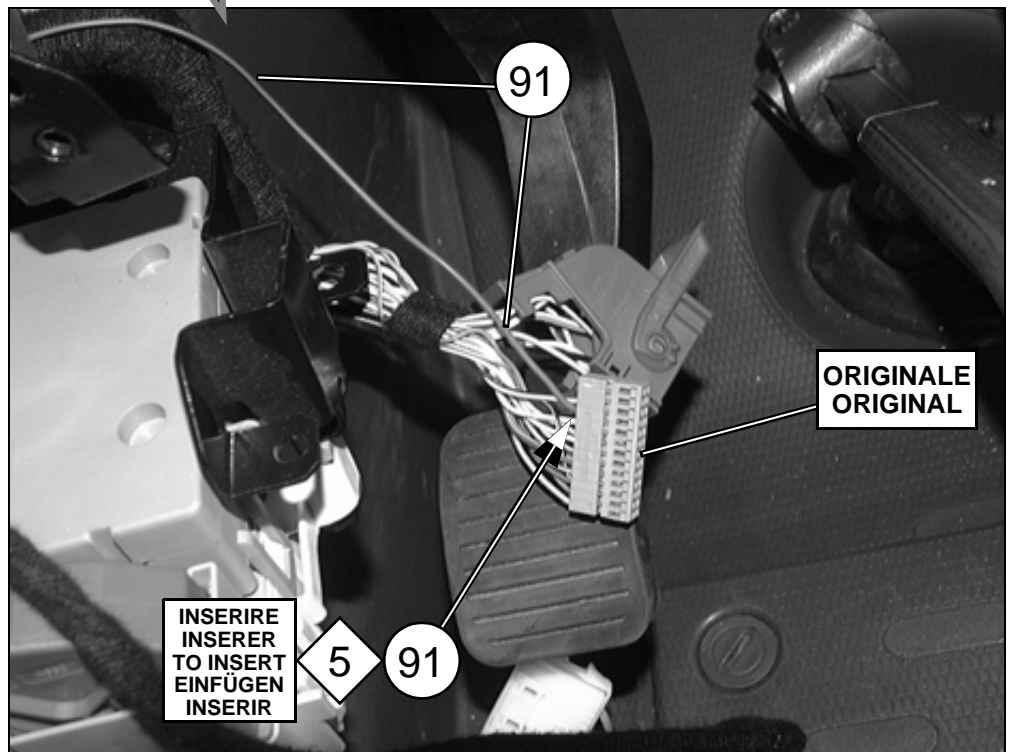

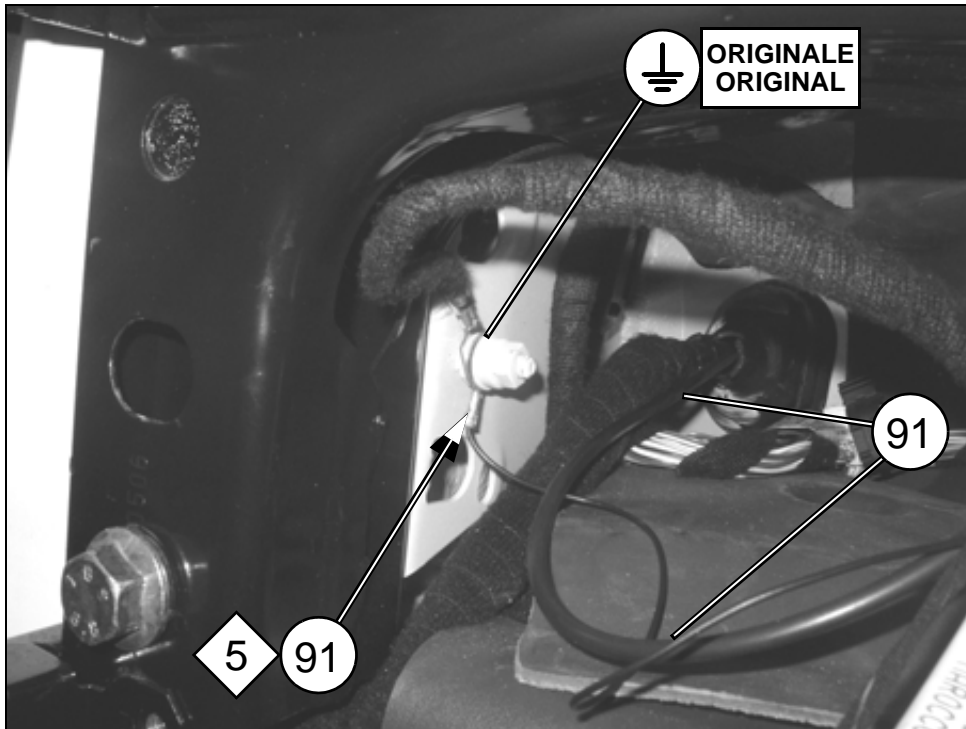

16D

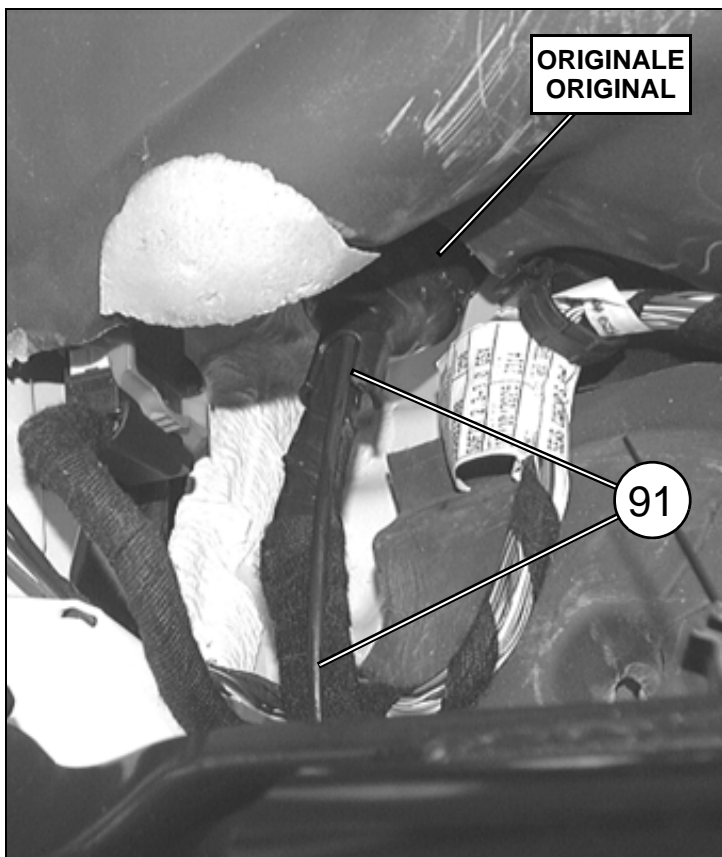

17D

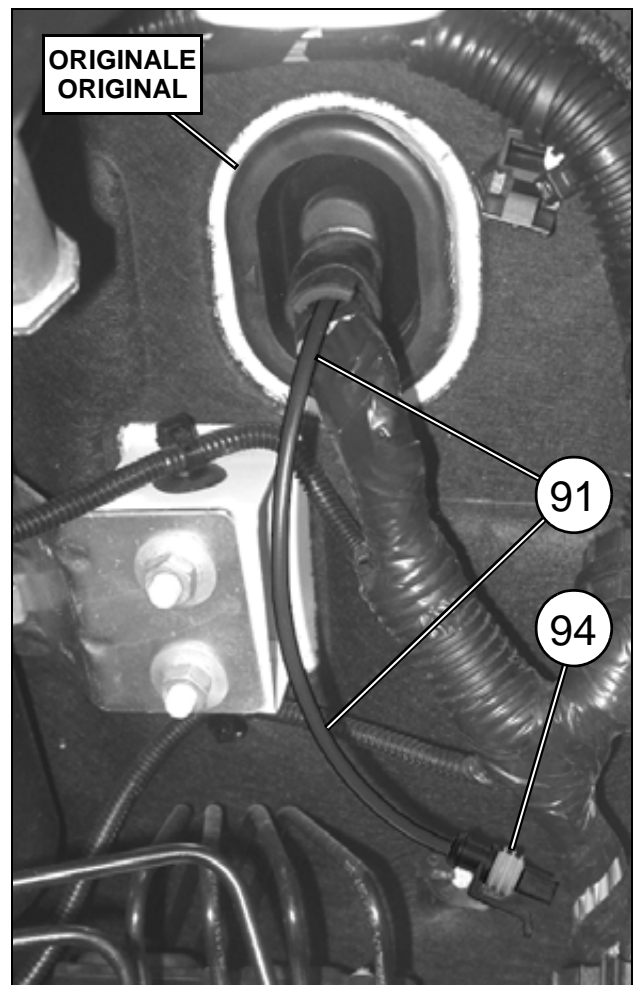



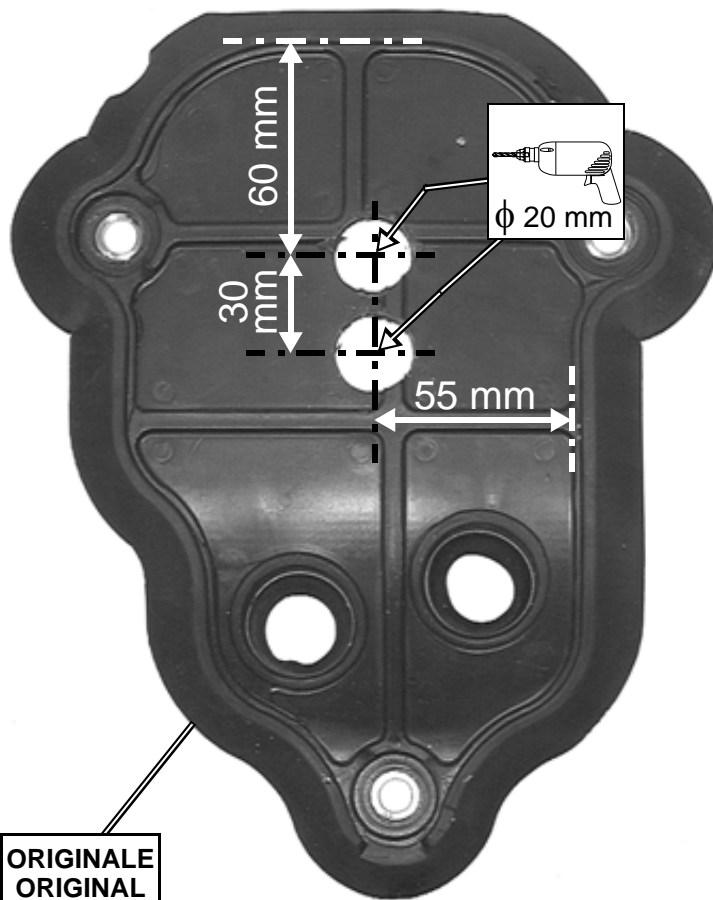

18D

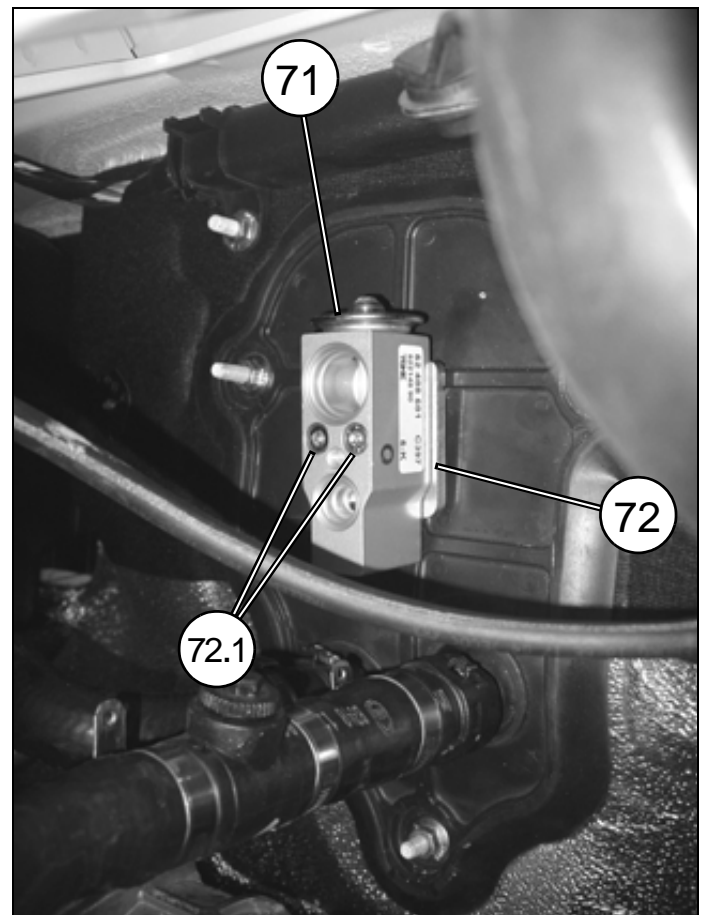
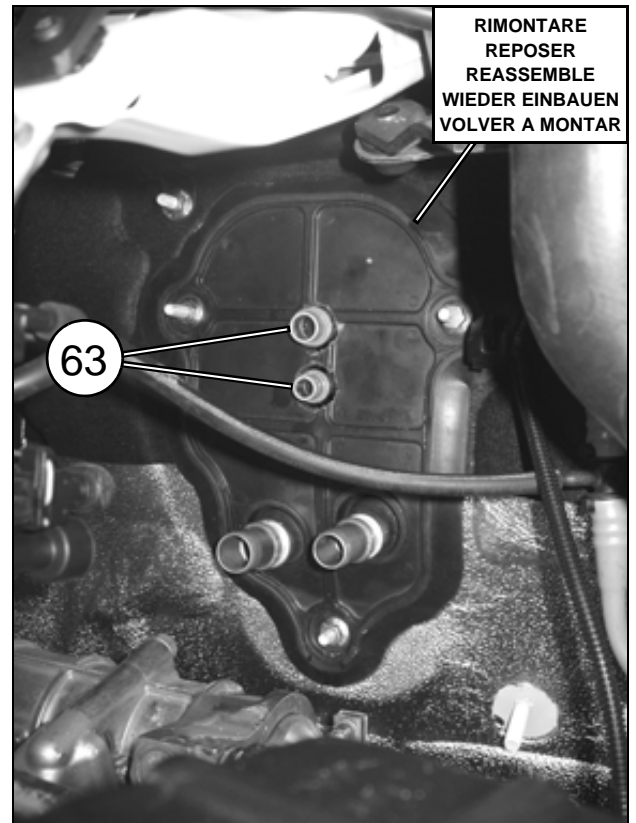

ELEMENTI DI FISSAGGIO / PIECES DE FIXATION FIXING PARTS / BEFESTIGUNGSELEMENTE ELEMENTOS DE FIJACION			
Pos.	Tipologia Typologie Typology Tipologie Tipologia	Descrizione Description Description Beschreibung Descripción	Codice Code Code Kode Codigo
72		Flangia tubi gas	043060/1
72.1		M5 x 35	-



19D

- (I)**  
Rimontare all'interno dell'abitacolo tutti i componenti originali smontati in precedenza.
- (F)**  
Réposer dans l'habitacle tous les composants d'origine démontés.
- (GB)**  
Reassemble all the original components in the passenger compartment.
- (D)**  
Alle vorher ausgebauten Originalbestandteile wieder im Fahrzeuginneren einbauen.
- (E)**  
Volver a montar en el interior del habitáculo todos los componentes originales desmontados anteriormente.



**COLLEGAMENTO TUBI GAS-INSTALLAZIONE COMPONENTI ELETTRICI NEL VANO MOTORE  
 RACCORDEMENT DES TUYAUX GAZ-INSTALLATION COMPOSANTS ELECTRIQUES DANS LE COMPARTIMENT MOTEUR  
 GAS PIPE CONNECTION-INSTALLATION OF ELECTRICAL COMPONENTS IN THE ENGINE COMPARTMENT  
 KAEITEMITTELSCHLAUCHVERBINDUNG-INSTALLATION DER ELEKTRISCHEN TEILE IM MOTORRAUM  
 CONEXION TUBOS GAS-INSTALACION COMPONENTES ELECTRICOS EN EL COMPARTIMENTO MOTOR**

MATERIALE FORNITO / MATERIEL FOURNI / SUPPLIED MATERIAL / GELIEFERTES MATERIAL / MATERIAL ABASTECIDO

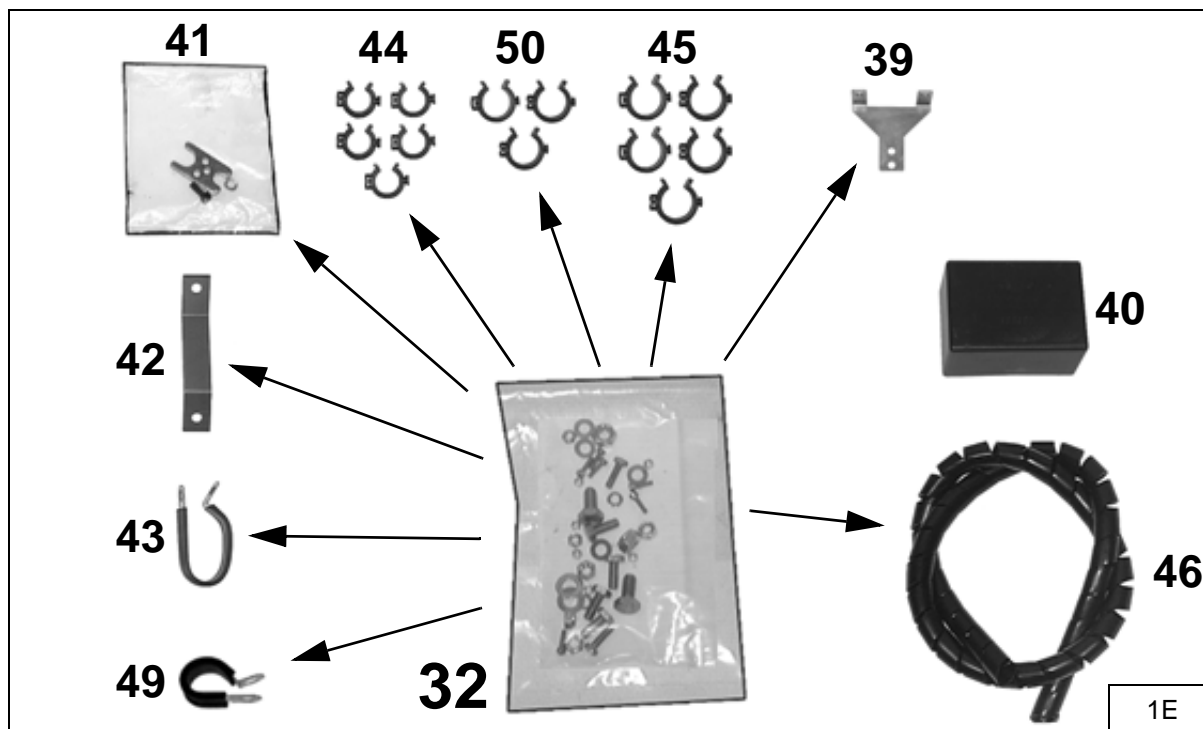

Pos.	Descrizione / Description / Description / Beschreibung / Descripción	Codice / Code Kode / Código
32	Sacchetto accessori	0232126/0
39	Staffa ausiliaria di supporto Impianto elettrico elettroventole	0811266/0
40	Copri-relais	0361158/0
41	Sacchetto flangia	043066/3
42	Staffa di supporto tubi gas	0361820/0
43	Fascetta in gomma	069241/1
44	Fermatubo $\phi$ 18	069635/0
45	Fermatubo $\phi$ 24	069637/0
46	Protezione a spirale	0701486/0
49	Fascetta in gomma	069033/0
50	Fermatubo $\phi$ 22	069636/0

TUBI GAS / TUYAUX GAZ / GAS PIPE / KAEITEMITTELSCHLÄUCHE / TUBOS GAS	
Descrizione / Description / Description / Beschreibung / Descripción	Codice / Code Kode / Código
Tubo gas 5/16"CF (condensatore-filtro)	806E184
Tubo gas 5/16"FE (filtro-evaporatore)	806E185/1
Tubo gas 13/32"CC (compressore-condensatore)	808E186/1
Tubo gas 1/2"EC (evaporatore-compressore)	810E187

MATERIALE FORNITO / MATERIEL FOURNI / SUPPLIED MATERIAL / GELIEFERTES MATERIAL / MATERIAL ABASTECIDO

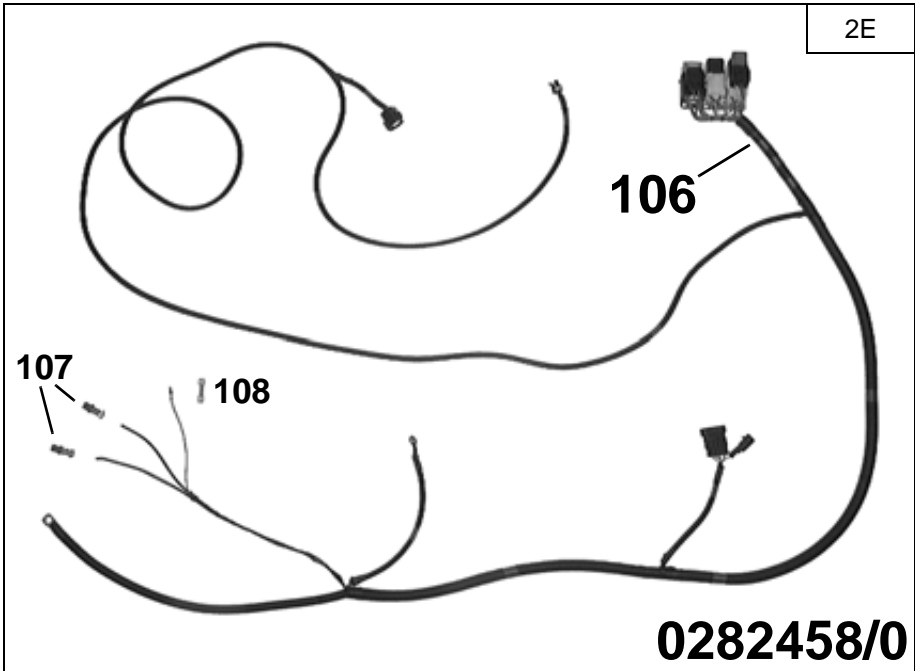

Pos.	Descrizione Description / Description Beschreibung / Descripción	Codice Code / Kode Codigo
106	Impianto elettrico Elettroventole	0282458/0
107	Terminale	-
108	Giunzione RAYCHEM ROSSA	064274/0
109	Cablaggio supplementare	0282564/0

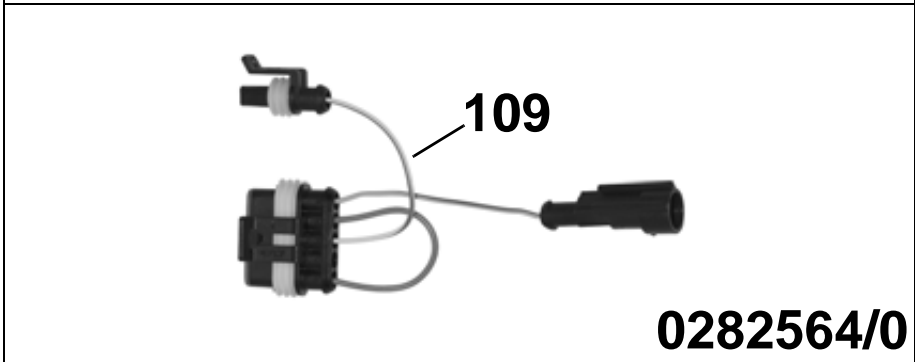

POSIZIONAMENTO IMPIANTO ELETTRICO NEL VANO MOTORE (vedi schema elettrico allegato)  
 POSITIONNEMENT DU FAISCEAU ELECTRIQUE DANS LE COMPARTIMENT MOTEUR (voir schéma électrique joint)  
 POSITIONING THE ELECTRIC SYSTEM WIRING WITHIN THE ENGINE COMPARTMENT (see the enclosed wiring diagram)  
 POSITIONIERUNG DER ELEKTRISCHEN ANLAGE IM MOTORRAUM (siehe Schaltschema im Anhang)  
 COLOCACIÓN DE LA INSTALACIÓN ELÉCTRICA EN EL ESPACIO MOTOR (véase esquema eléctrico adjunto)

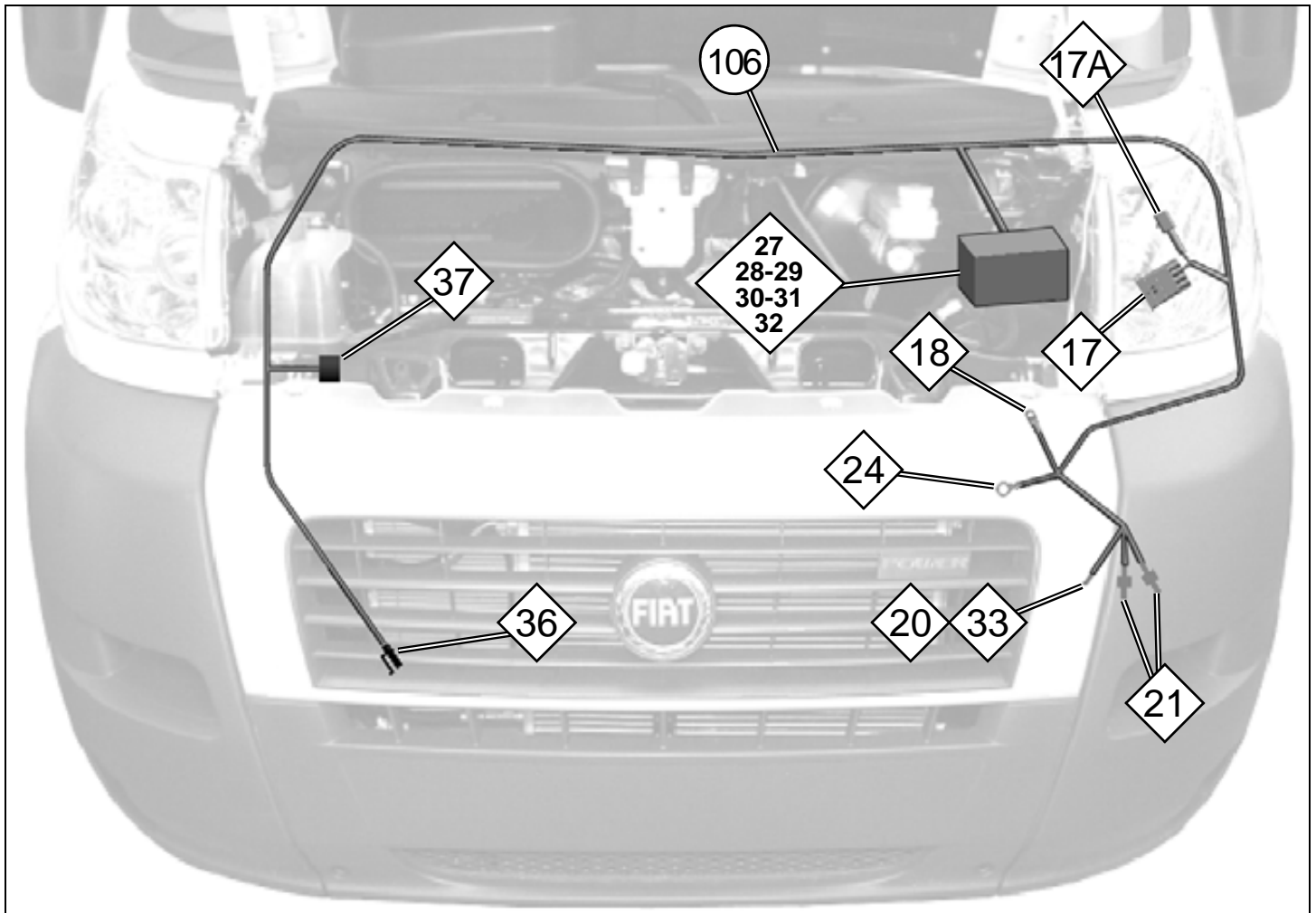

3E

106 → **0282458/0**

VEDI Fig. 4E-5E-6E-7E-8E  
 VOIR Fig. 4E-5E-6E-7E-8E  
 SEE Fig. 4E-5E-6E-7E-8E  
 SIEHE Abb. 4E-5E-6E-7E-8E  
 VÉASE Fig. 4E-5E-6E-7E-8E

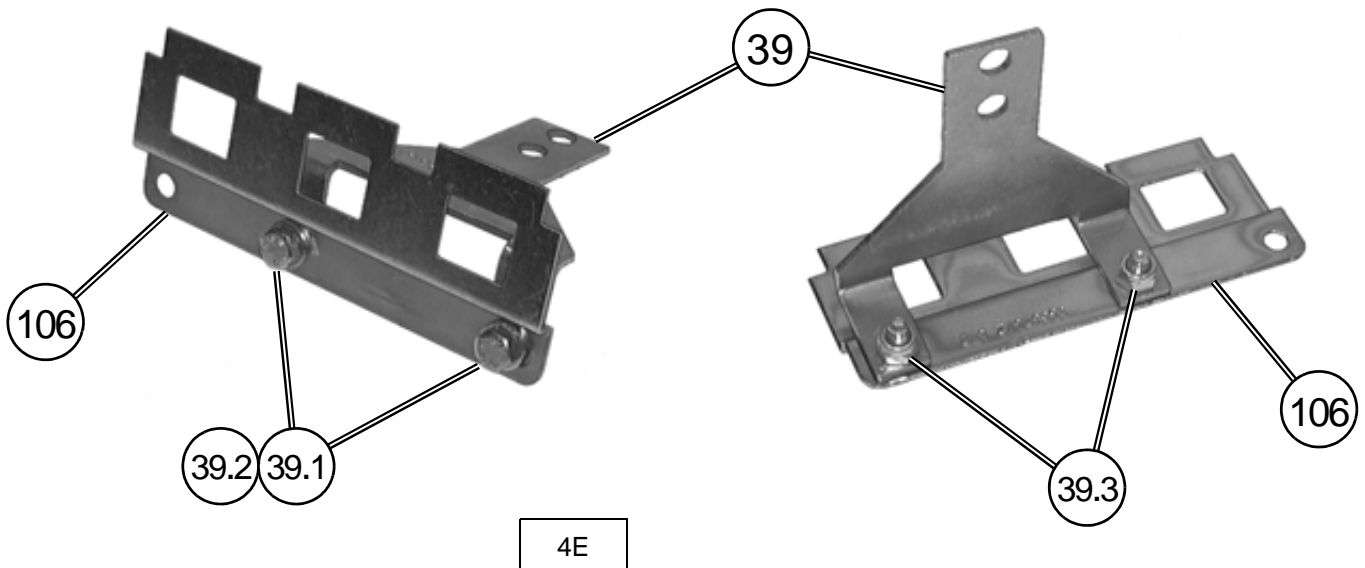

4E

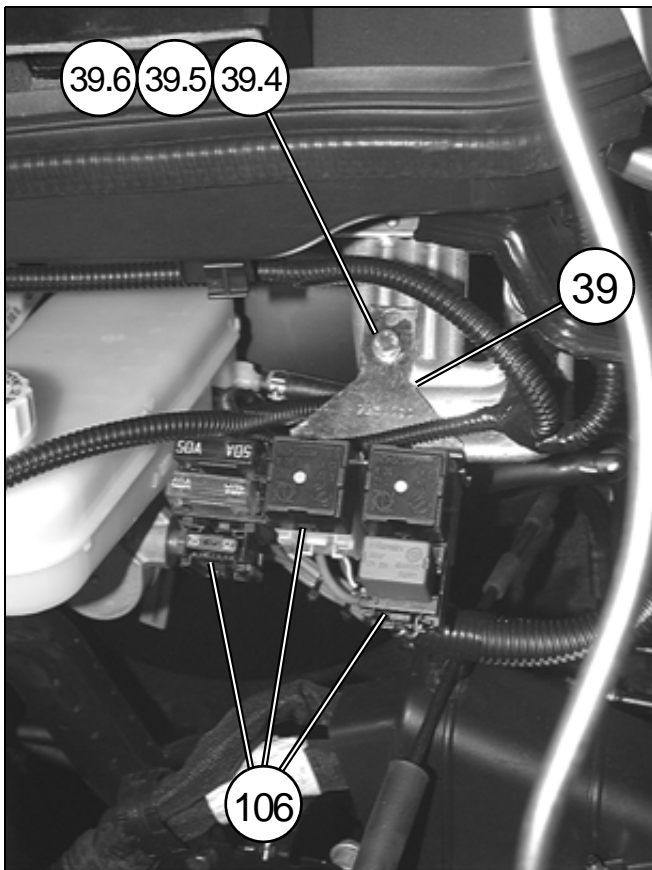

ELEMENTI DI FISSAGGIO / PIÈCES DE FIXATION FIXING PARTS / BEFESTIGUNGSELEMENTE ELEMENTOS DE FIJACION		
Pos.	Tipologia / Typologie Typology / Tipologie Tipologia	Descrizione / Description Description / Beschreibung Descripción
39.1		M5x12
39.2		φ 5
39.3		M5
39.4		M6x16
39.5		φ 6
39.6		M6

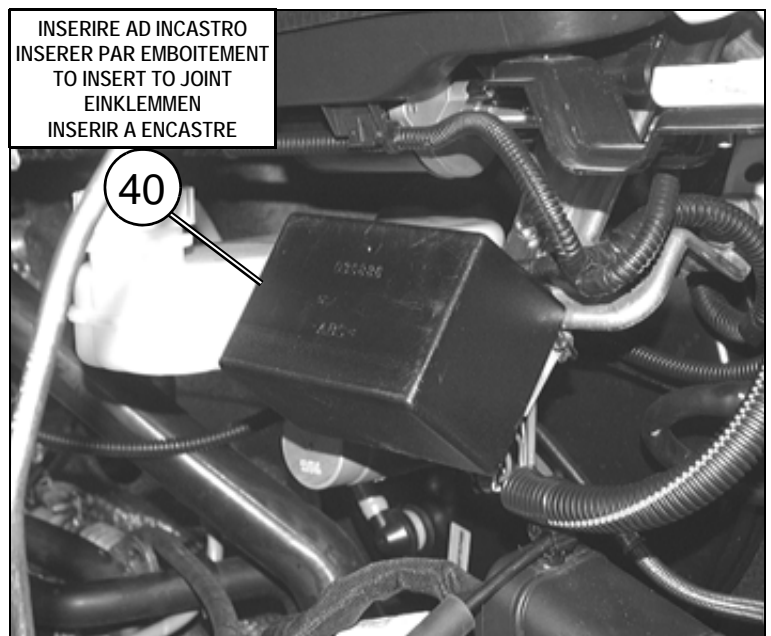

ELIMINARE  
ELIMINER  
DISCARD  
ENTFERNEN  
ELIMINAR

ORIGINALI  
ORIGINALS

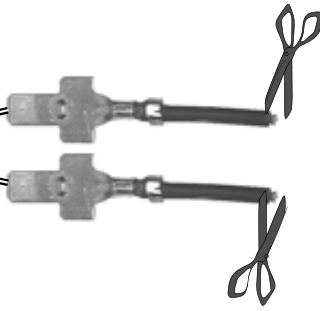

5E

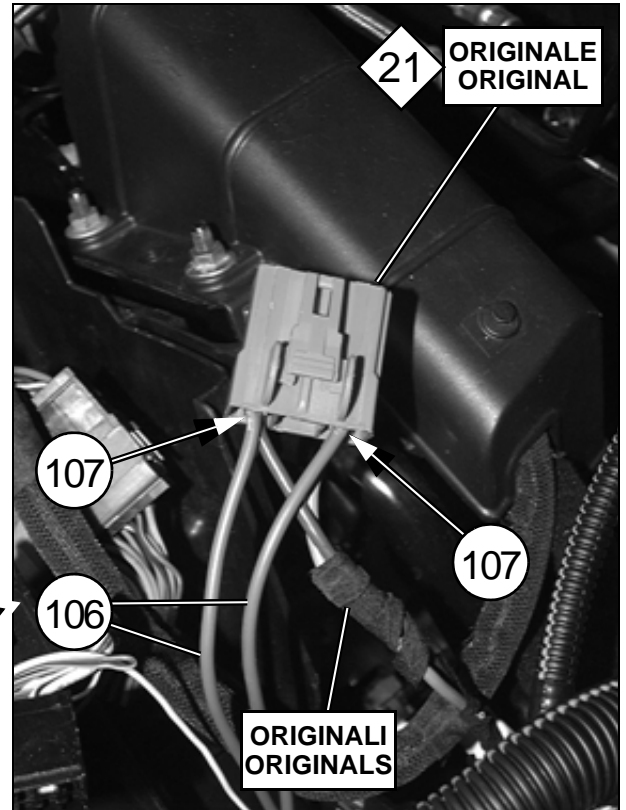
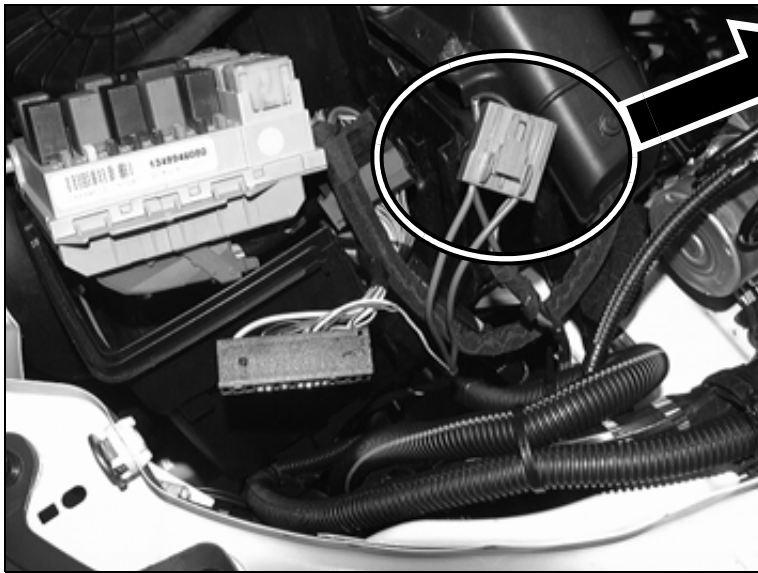



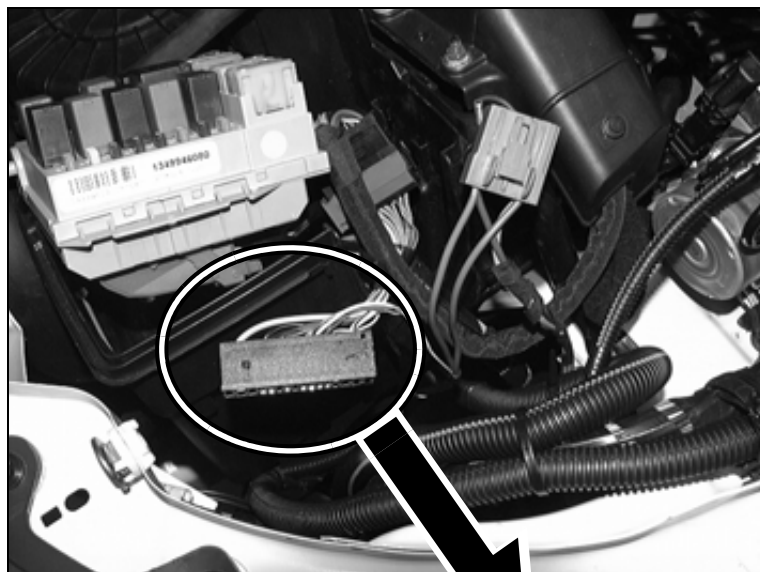

(I)  
**ATTENZIONE:** nel caso in cui nel connettore originale sia presente il cavo originale alla posizione n° 27, collegare il cavo "BIANCO-ROSSO" dell'impianto elettrico "106" mediante giunzione RAYCHEM "108".

(F)  
**ATTENTION:** si dans le connecteur d'origine il y a présence du fil d'origine à la position n° 27, connecter le fil "BLANC-ROUGE" du faisceau électrique "106" à l'aide du raccord RAYCHEM "108".

6E

SMONTARE  
DEMONTER  
REMOVE  
AUSBAUEN  
DESMONTAR

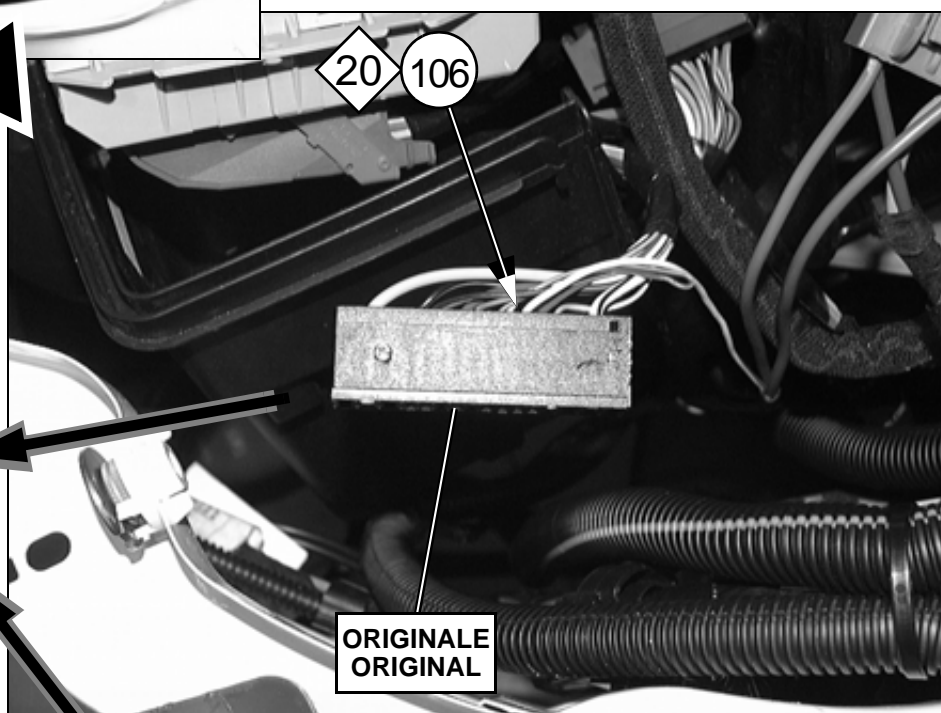

(GB)  
**WARNING:** if the original connector has the original wire in position no. 27, hook up the "WHITE-RED" wire of the supplied electrical system "106" using the Raychem connector "108".

(D)  
**ACHTUNG:** sollte im Original-Steckverbinder das Original-Kabel an Position Nr.27 sich befinden, Kabel "WEISS-ROT" der elektrischen Anlage "106" mit Raychem-Verbindung "108" anschließen

(E)  
**ATENCIÓN:** en caso de que en el conector original esté presente el cable original en la posición n° 27, conectar el cable "BLANCO-ROJO" de la instalación eléctrica "106" a través de junta RAYCHEM "108".

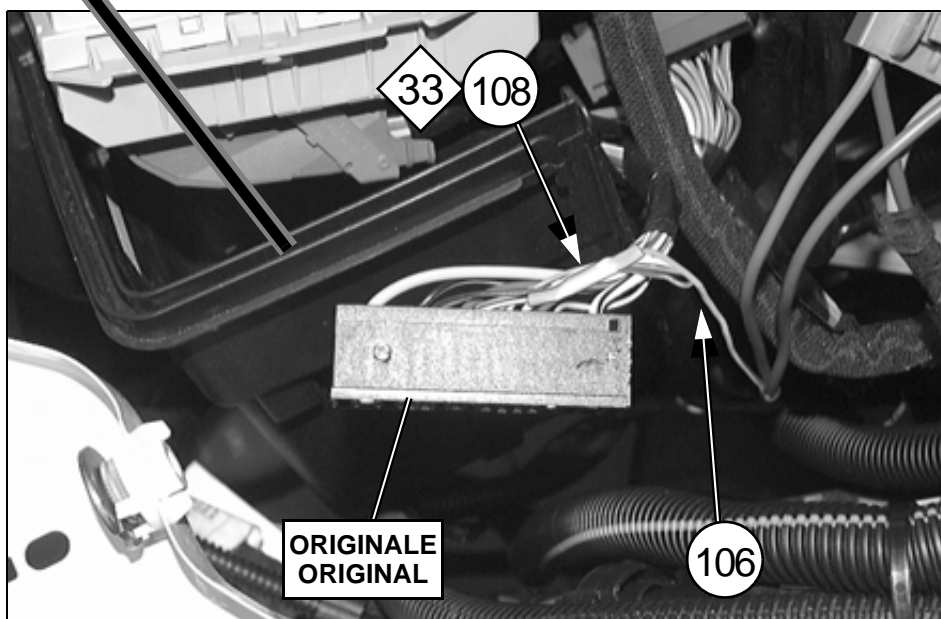

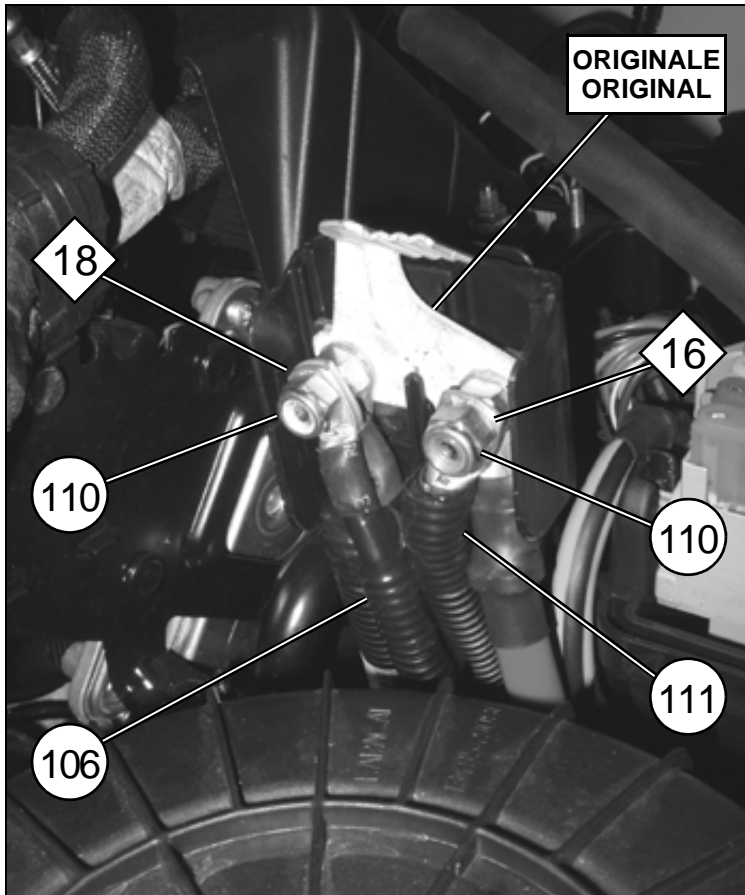

7E

ELEMENTI DI FISSAGGIO / PIECES DE FIXATION FIXING PARTS / BEFESTIGUNGSELEMENTE ELEMENTOS DE FIJACION		
Pos.	Tipologia / Typologie Typology / Tipologie Tipologia	Descrizione / Description Description / Beschreibung Descripción
110		M8

8E

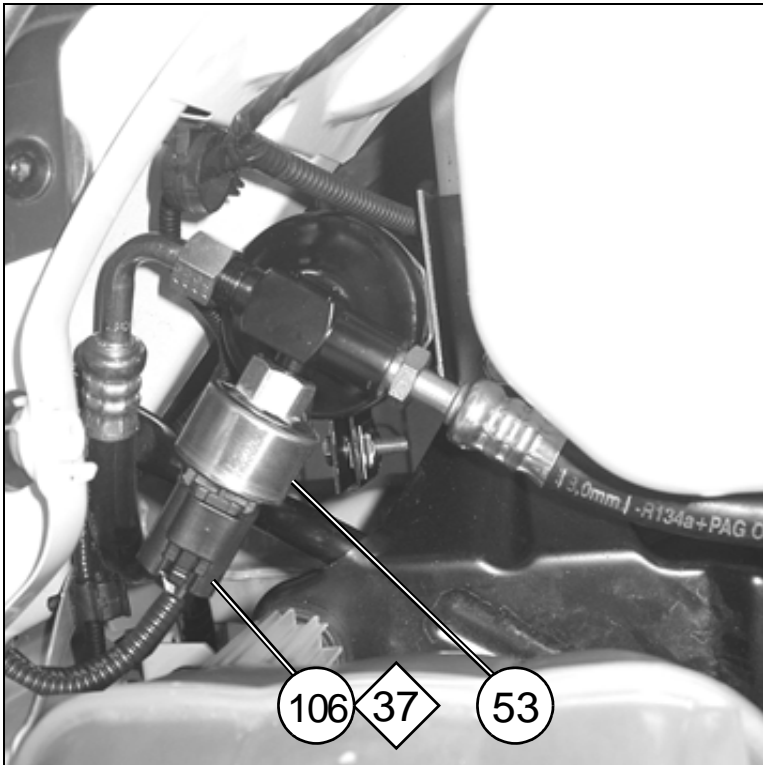

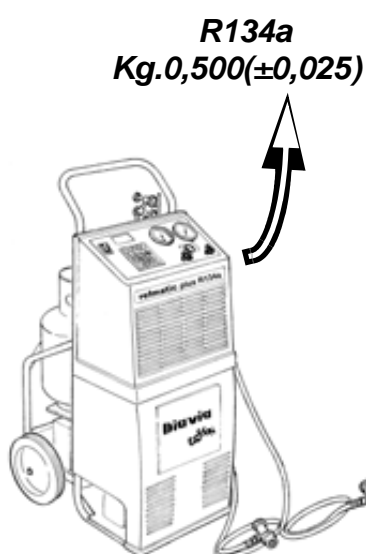
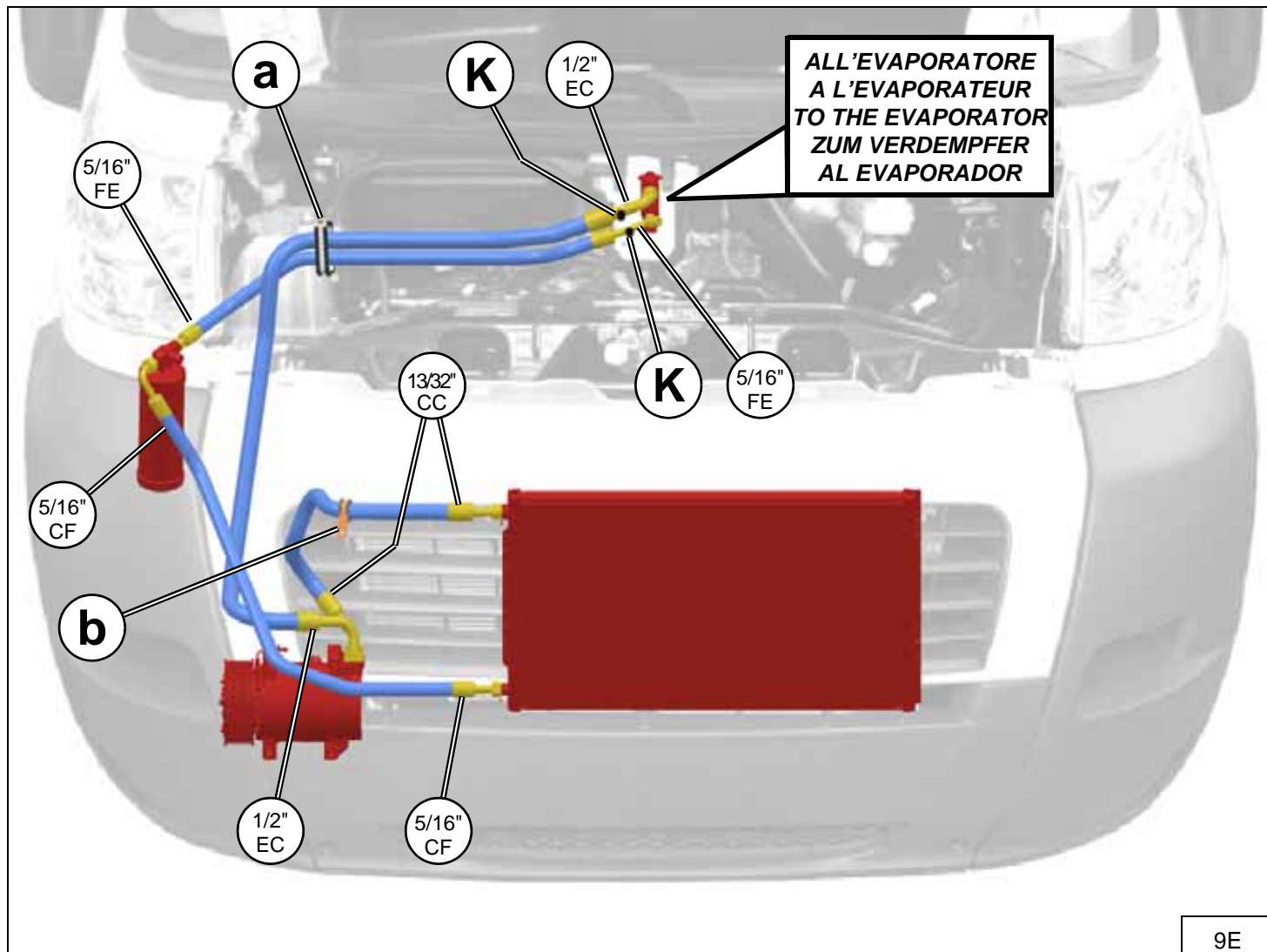

**R134a**  
Kg.0,500(±0,025)

(I)

**Vista complessiva passaggio tubi gas nel vano motore.**

Alle posizioni "a-b" sono evidenziati i punti di fissaggio tubi alla vettura, descritti in particolare nelle figure che seguono. Alle posizioni "K" sono evidenziate le valvole di carica dell'impianto aria condizionata predisposte sui raccordi tubi gas 1/2"EC e 5/16"FE.

(F)

**Vue d'ensemble du passage des tuyaux gaz dans le compartiment moteur.**

Les points de fixation des tuyaux à la voiture, décrits en détail sur les figures qui suivent, sont mis en évidence aux positions "a-b". Aux pos. "K" on a indiqué les soupapes de charge équipement A/C prévues sur les raccords des tuyaux gaz 1/2"EC et 5/16"FE.

(GB)

**General view of the gas hoses in the engine compartment.**

Positions "a-b" indicate the points for securing pipes to the vehicle, described in detail in the following figures. At the position "K", the A/C system charge valves prepared on the 1/2"EC and 5/16"FE gas hoses couplings are shown.

(D)

**Gesamtansicht des Durchgangs der Kältemittelschläuche im Motorraum.**

Bei den Positionen "a-b" sind die Befestigungspunkte der Schläuche am Fahrzeug hervorgehoben. An den Positionen "K" sind die Füllventile der Klimaanlage an den Anschlüssen der 1/2"EC und 5/16"FE-Kältemittelschläuchen hervorgehoben.

(E)

**Vista total paso tubos gas en el compartimiento motor.**

En las posición "a-b" se evidencian los puntos de sujeción de los tubos al coche, descritos detalladamente en las figuras que siguen. En las posiciones "K" están evidenciadas las válvulas de carga de la instalación aire acondicionado preparados en los racord tubos gas 1/2"EC y 5/16"FE.



10E

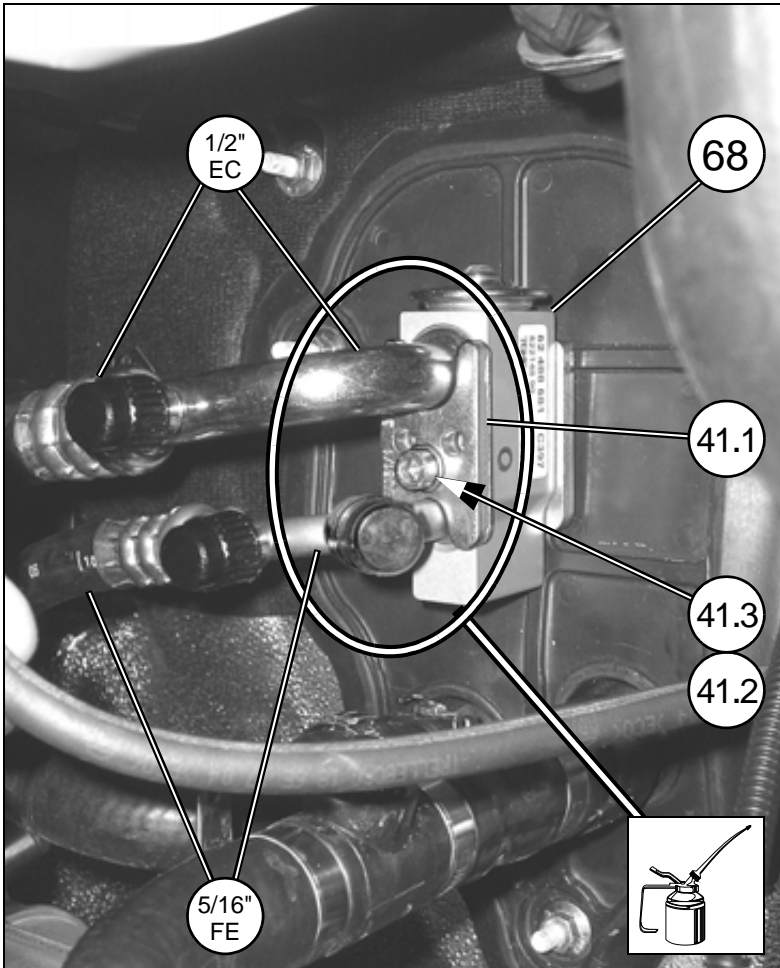

ELEMENTI DI FISSAGGIO / PIECES DE FIXATION FIXING PARTS / BEFESTIGUNGSELEMENTE ELEMENTOS DE FIJACION			
Pos.	Tipologia Typologie Typology Tipologie Tipologia	Descrizione Description Description Beschreibung Descripción	Codice Code Code Codigo
41.1		Flangia tubi gas	043061/2
41.2		M6x16	-
41.3		φ6	-

11E

ELEMENTI DI FISSAGGIO / PIECES DE FIXATION FIXING PARTS / BEFESTIGUNGSELEMENTE ELEMENTOS DE FIJACION		
Pos.	Tipologia / Typologie Typology / Tipologie Tipologia	Descrizione / Description Description / Beschreibung Descripción
42.1		M6x20
42.2		φ6
42.3		M6

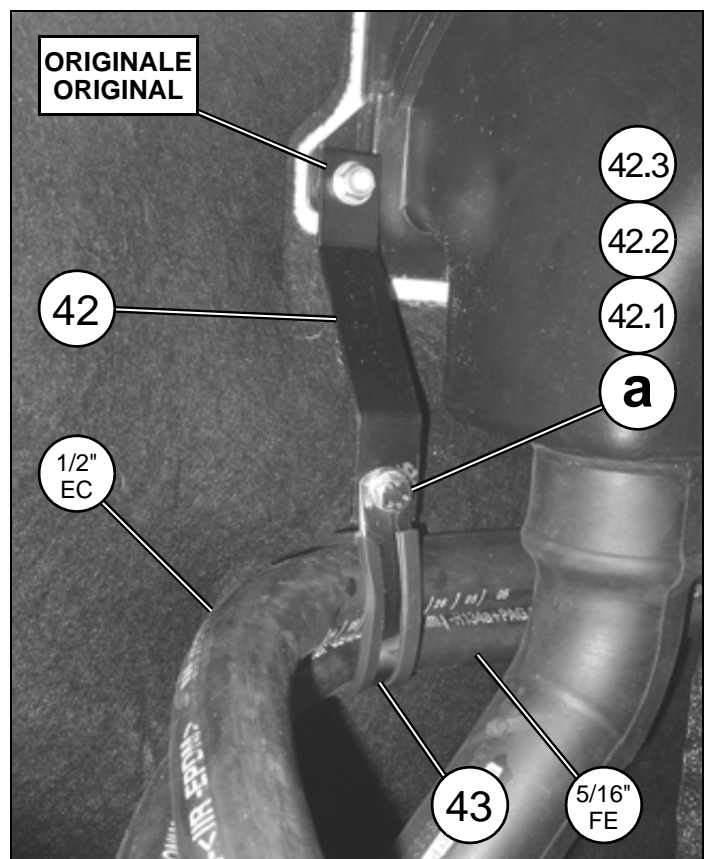

12E

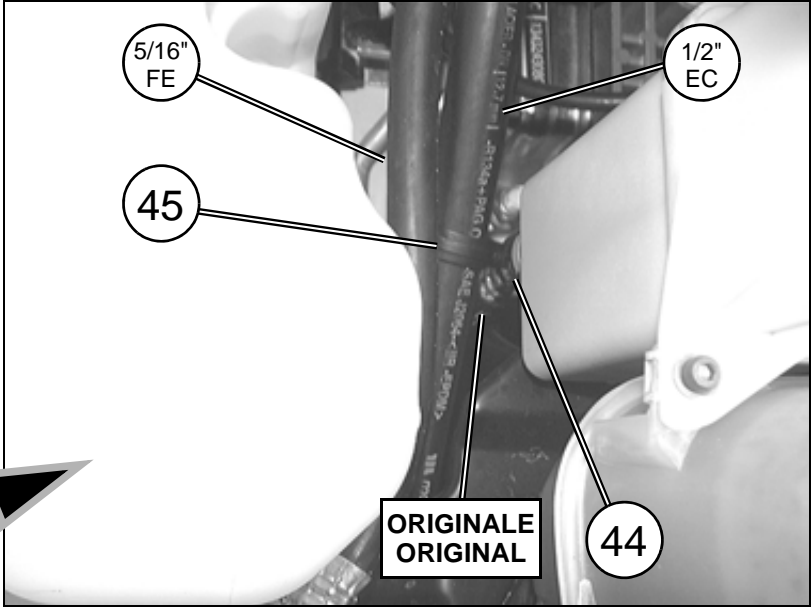
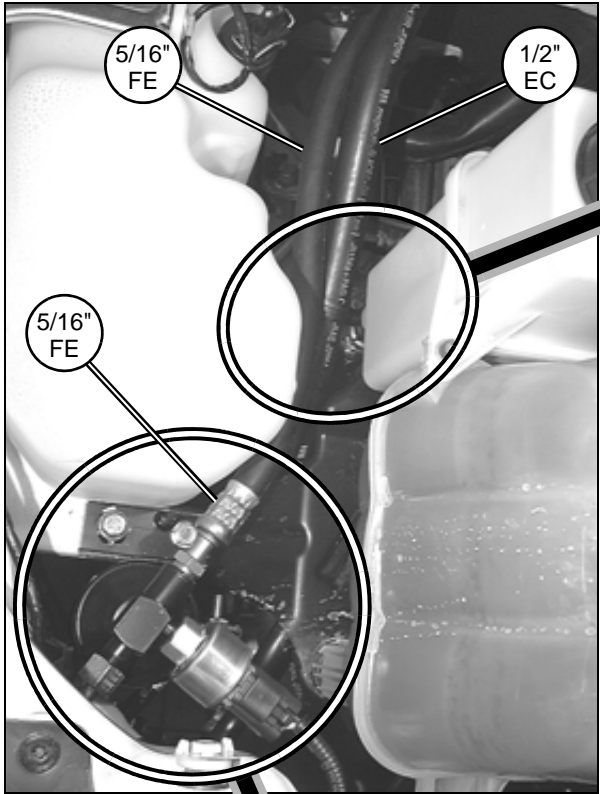

ELEMENTI DI FISSAGGIO / PIÈCES DE FIXATION FIXING PARTS / BEFESTIGUNGSELEMENTE ELEMENTOS DE FIJACION			
Pos.	Tipologia / Typologie Typology / Tipologie Tipologia	Descrizione / Description Description / Beschreibung Descripción	Codice / Code Code / Código
44		Fermatubo $\phi$ 18	069635/0
45		Fermatubo $\phi$ 24	069637/0

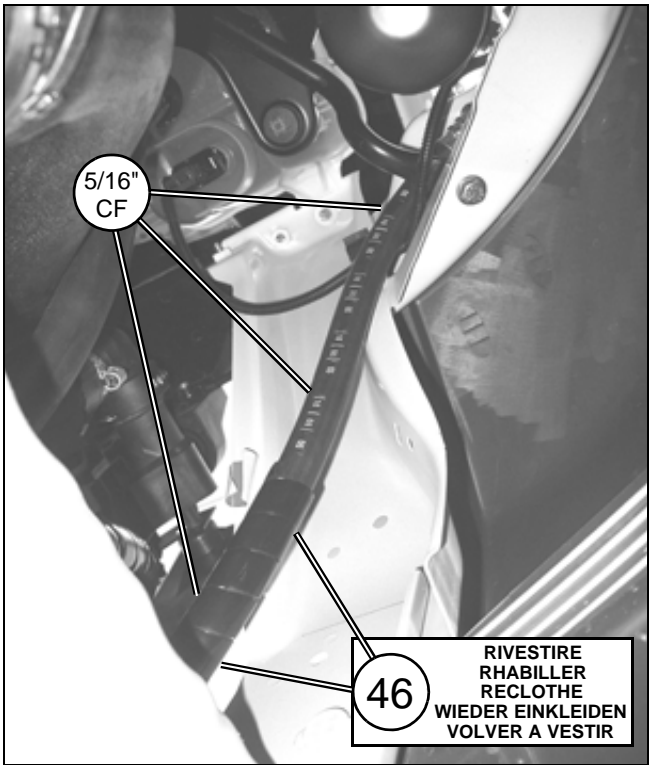
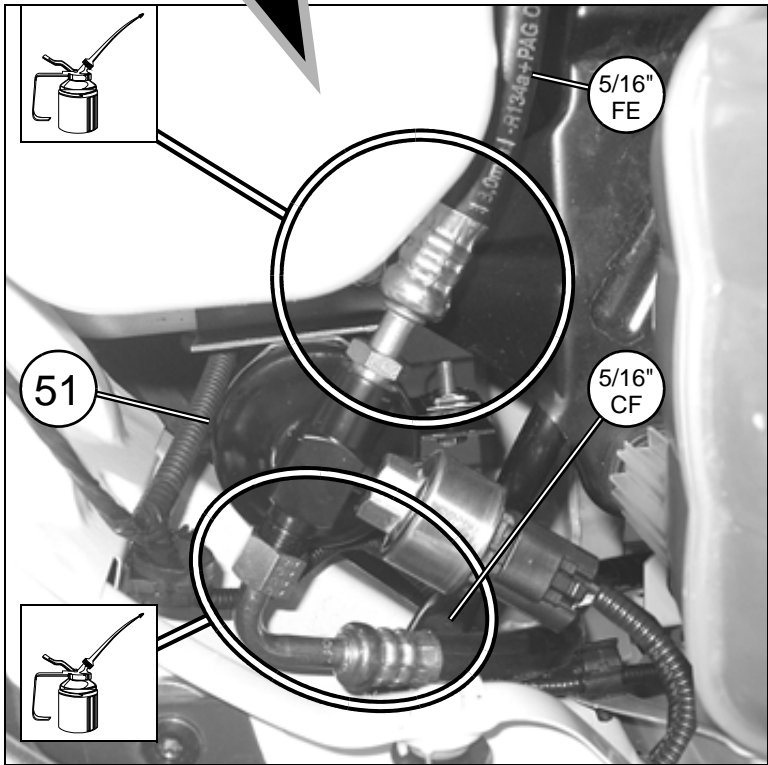



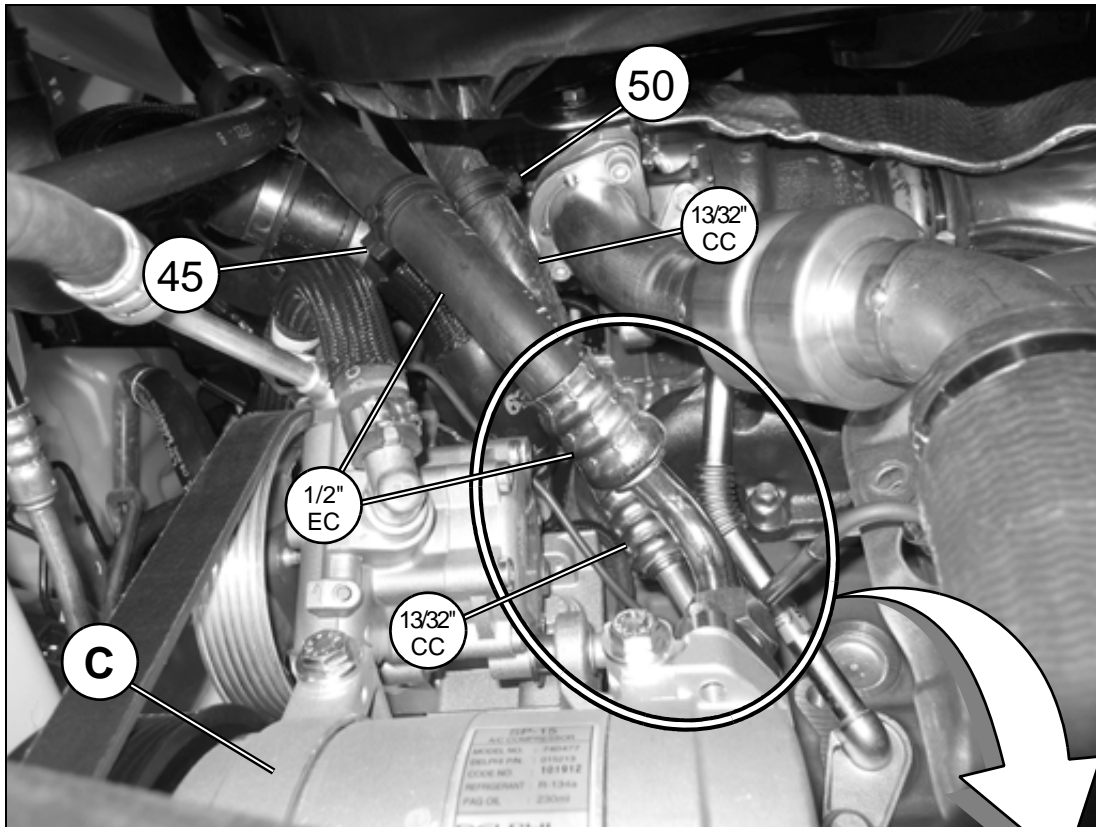

13E

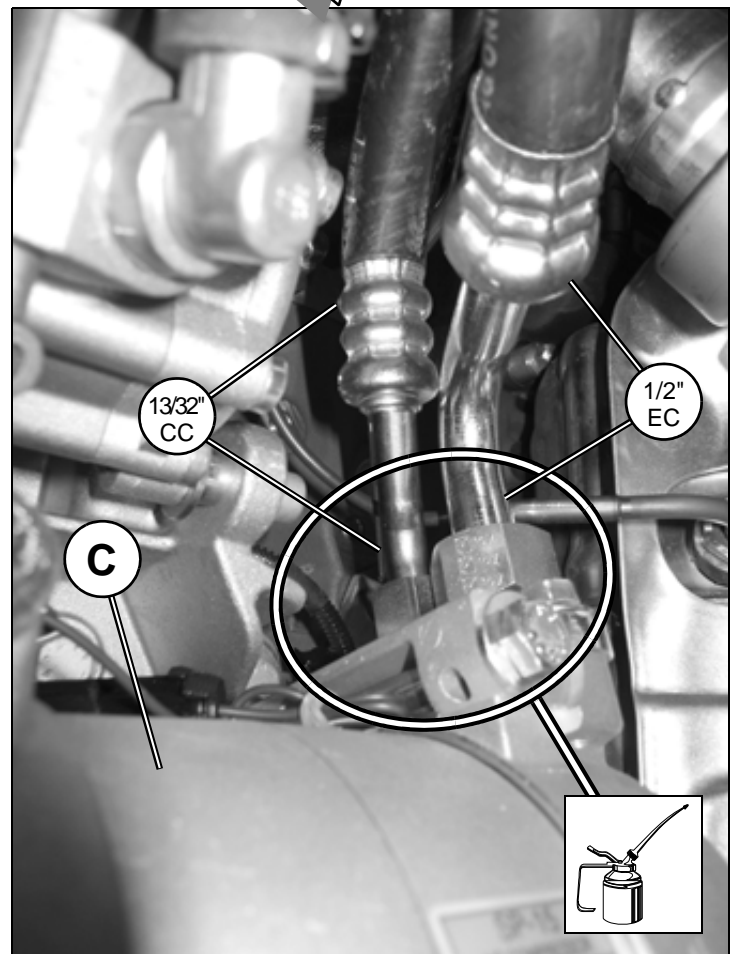

ELEMENTI DI FISSAGGIO / PIECES DE FIXATION FIXING PARTS / BEFESTIGUNGSELEMENTE ELEMENTOS DE FIJACION			
Pos.	Tipologia Typologie Typology Tipologie Tipologia	Descrizione Description Description Beschreibung Descripción	Codice Code Code Codigo
45		Fermatubo $\phi$ 24	069637/0
50		Fermatubo $\phi$ 22	069636/0

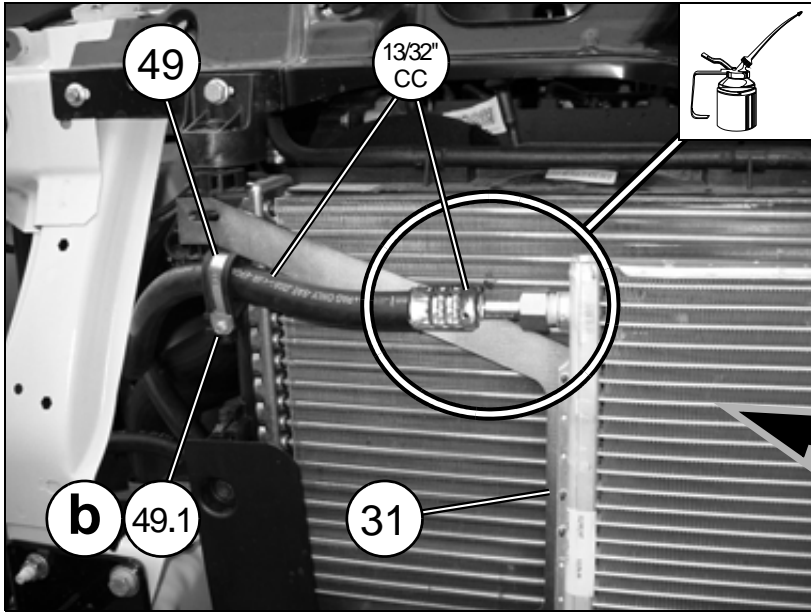

14E

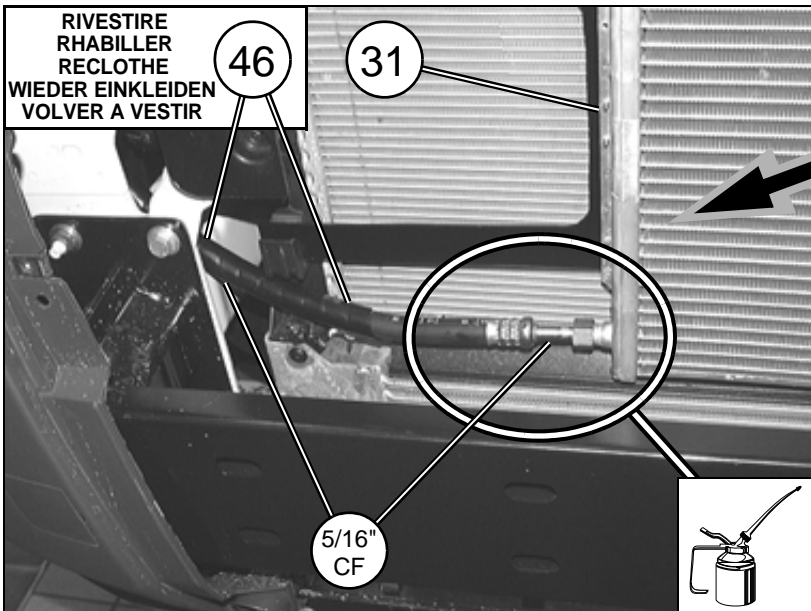
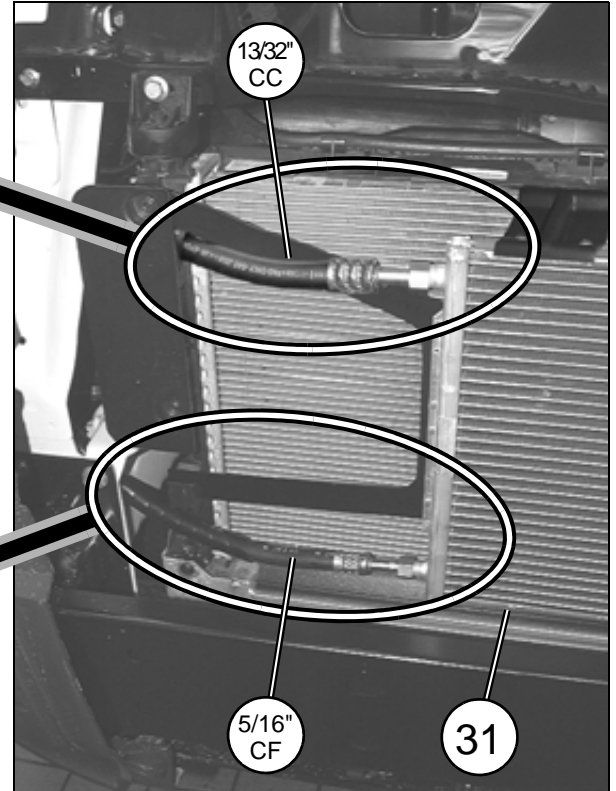

RIVESTIRE  
RHABILLER  
RECLOTHE  
WIEDER EINKLEIDEN  
VOLVER A VESTIR

ELEMENTI DI FISSAGGIO / PIECES DE FIXATION FIXING PARTS / BEFESTIGUNGSELEMENTE ELEMENTOS DE FIJACION		
Pos.	Tipologia / Typologie Typology / Tipologie Tipologia	Descrizione / Description Description / Beschreibung Descripción
49.1		4.2x16

**SCHEMA IMPIANTO ELETTRICO / SCHEMA DE L'INSTALLATION ELECTRIQUE / WIRING DIAGRAM**  
**SCHEMA DER ELEKTRISCHEN ANLAGE / ESQUEMA INSTALACION ELECTRICA**  
**FIAT DUCATO 2.3 MJT - EURO 5**

28/01/13

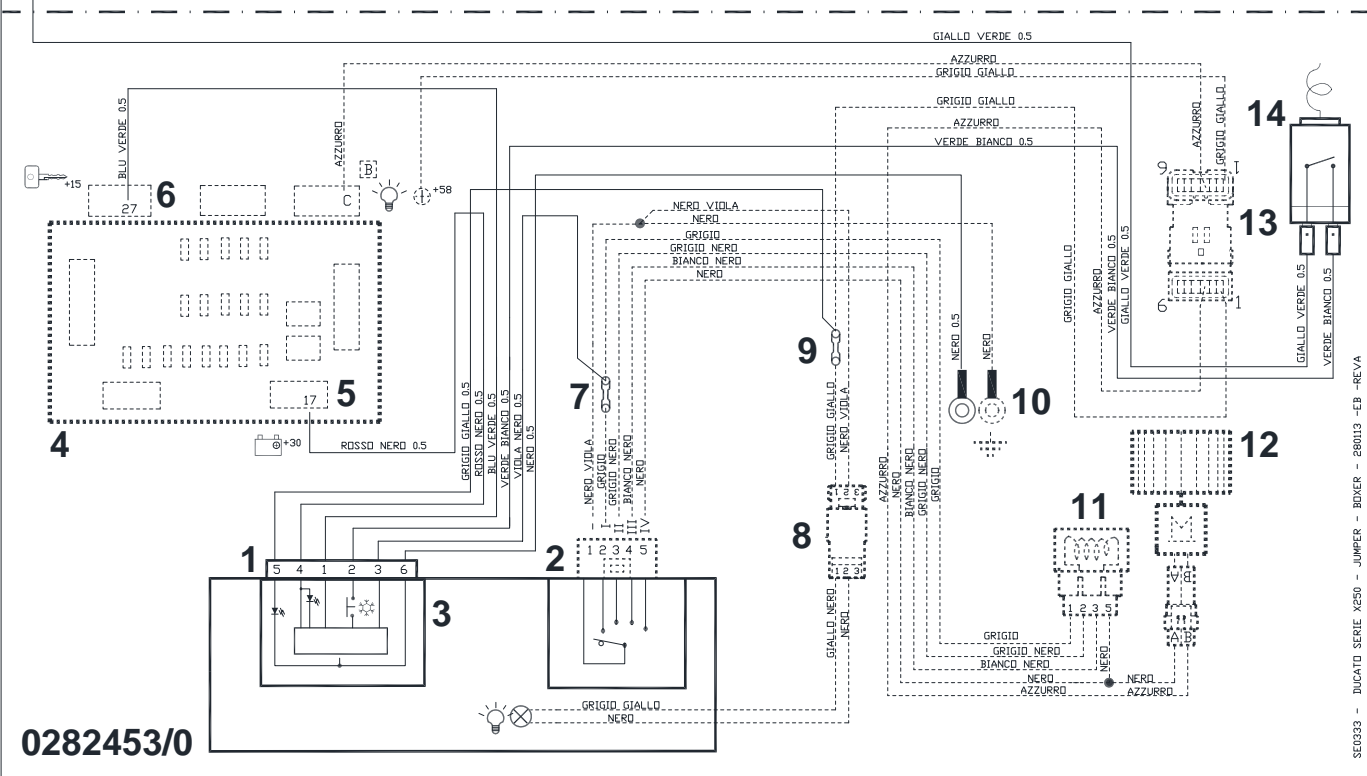
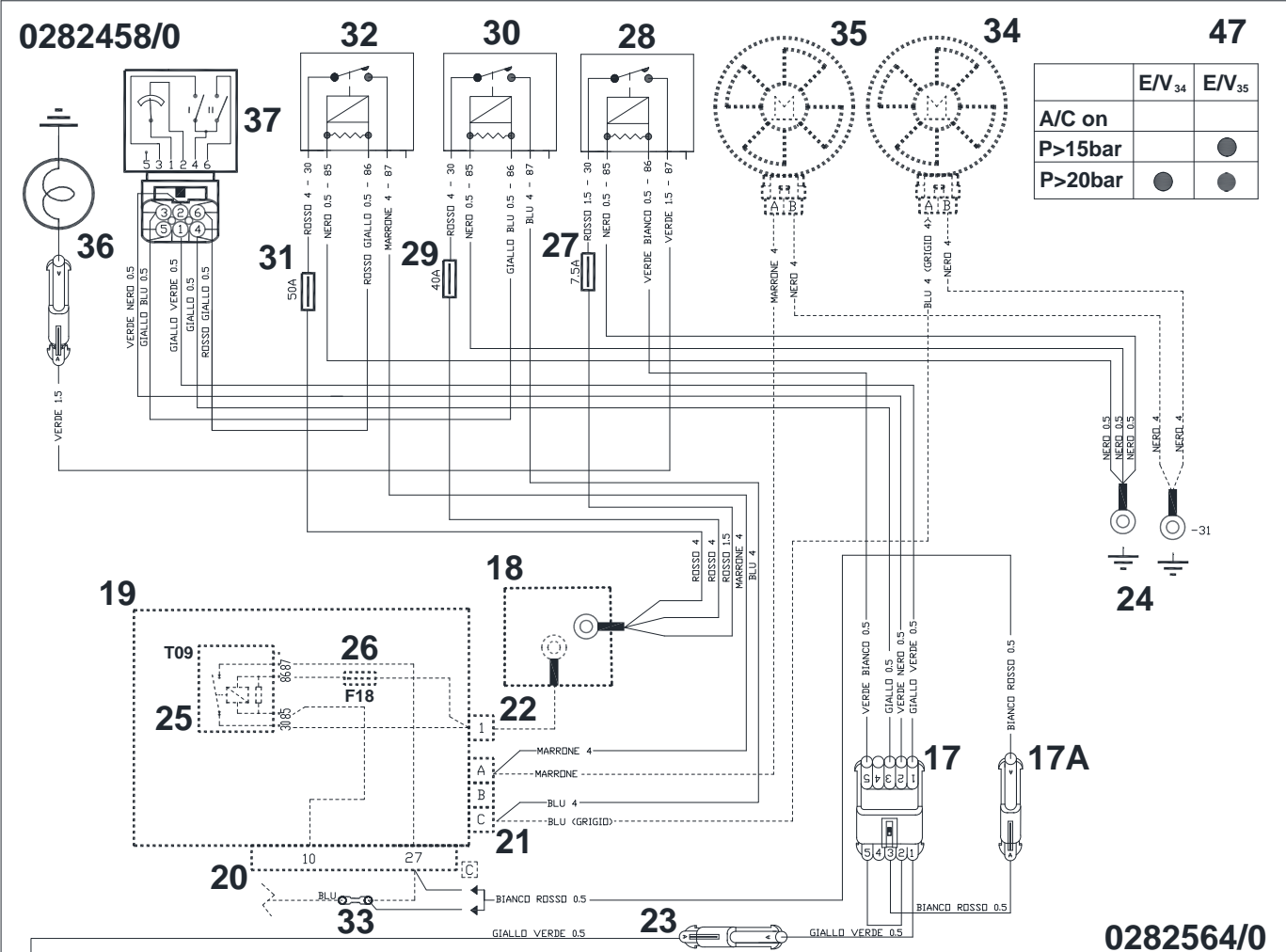

0282453/0

0282564/0

SE0333 - DUCATO SERIE X250 - JUMPER - BOXER - 28013 - EB - REVA

N.	Descrizione / Description / Description Beschreibung / Descripción	Funzione / Fonction / Function Funktion / Función
1	Connettore 6 vie / Connecteur à 6 voies / 6-way connector 6-weg-Steckverbinder / Conector 6 vía	
2	Connettore 5 vie / Connecteur à 5 voies / 5-way connector 5-weg-Steckverbinder / Conector 5 vía	
3	Interruttore di comando A.C. Interrupteur de commande A.C. A.C. control switch Klimaanlagenschalter Interruptor de comando A.C	
4	Scatola porta relay Boîte à relais Relay box Relaiskasten Caja porta-realais	
5	Connettore 52 vie / Connecteur à 52 voies / 52-way connector 52-weg-Steckverbinder / Conector 52 vía	
6	Connettore 36 vie / Connecteur à 36 voies / 36-way connector 36-weg-Steckverbinder / Conector 36 vía	
7	Giunzione RAYCHEM BLU Raccord RAYCHEM BLEU BLUE RAYCHEM connector RAYCHEM Verbindung BLAU Junta RAYCHEM TURQUI	Collegamento con 1° velocità di ventilazione Connexion avec 1° vitesse de ventilation Connection to the 1st fan speed Anschlub mit der 1. Lüftungsgeschwindigkeit Conexión con 1° velocidad ventilación
8	Connettore 3 vie / Connecteur à 3 voies / 3-way connector 3-weg-Steckverbinder / Conector 3 vía	
9	Giunzione RAYCHEM ROSSO Raccord RAYCHEM ROUGE RED RAYCHEM connector RAYCHEM Verbindung ROT Junta RAYCHEM ROJO	Collegamento con +LUCI (+58) Connexion aux BLOCS OPTIQUES (+58) Connection to the LIGHTS (+58) Anschlub mit +LICHT (+58) Conexión con +LUCES (+58)
10	Terminale ad occhiello Borne en boutonnière Ring terminal Ösenstecker Terminal a ojillo	Collegamento con MASSA (-31) Connexion à la MASSE (-31) Connection to GROUND (-31) Anschlub mit Masse (-31) Conexión con MASA (-31)
11	Resistore / Résistance / Resistor / Widerstand / Resistor	
12	Elettroventola abitacolo Pulseur de l'habitacle Passenger compartment air blower Elektrolüfter im Fahrzeuginnenraum Electroventilador del habitáculo	
13	Connettore 6 vie / Connecteur à 6 voies / 6-way connector 6-weg-Steckverbinder / Conector 6 vía	
14	Termostato / Thermostat / Thermostat Thermostat / Termostato	
17	Connettore 5 vie Connecteur à 5 voies 5-way connector 5-weg-Steckverbinder Conector 5 vías	Interfaccia impianto elettrico interno-esterno Interface installation électrique intérieure-extérieure Inner-outer electric system interface Elektrische Anlageninnenfläche innen-auben Frente instalación eléctrica interior-exterior
17A	Connettore 1 via Connecteur à 1 voie 1-way connector 1-weg-Steckverbinder Conector 1 vía	



18	<p>Terminale ad occhiello Borne en boutonnière Ring terminal Ösenstecker Terminal a ojillo</p>	<p>Collegamento con +BATTERIA (+30) Connexion à la BATTERIE (+30) Connection to the BATTERY (+30) Anschluss mit BATTERIE (+30) Conexión con BATERIA (+30)</p>
19	<p>Scatola porta fusibili / Boîte à fusibles / Fuse box Schmelzsicherungskasten / Caja porta-fusibles</p>	
20	<p>Connettore 32 vie (NERO) Connecteur à 32 voie (NOIR) 32-way connector (BLACK) 32-weg-Steckverbinder (SCHWARZ) Conector 32 vía (NEGRO)</p>	
21	<p>Connettore 3 vie / Connecteur à 3 voie / 3-way connector 3-weg-Steckverbinder / Conector 3 vía</p>	
22	<p>Terminale ad occhiello Borne en boutonnière Ring terminal Ösenstecker Terminal a ojillo</p>	<p>Punto di derivazione batteria Point de dérivation batterie Battery connector point Batterie-Abzweigungspunkt Punto de conexiones de la batería</p>
23	<p>Connettore 1 via Connecteur à 1 voie 1-way connector 1-weg-Steckverbinder Conector 1 vía</p>	<p>Interfaccia impianto elettrico interno-esterno Interface installation électrique intérieure-extérieure Inner-outer electric system interface Elektrische Anlageninnenfläche innen-auben Frente instalación eléctrica interior-exterior</p>
24	<p>Punto di massa originale / Point de masse d'origine Original ground point / Original-Massepunkt Punto de masa original</p>	
25	<p>Relay interruttore Relais de coupure Switch Relay Relais-Schalter Realais interruptor</p>	
26	<p>Fusibile 7.5A / Fusible 7.5A / 7.5A Fuse Schmelzsicherung 7.5A / Fusible 7.5A</p>	
27	<p>Fusibile 7.5A / Fusible 7.5A / 7.5A Fuse Schmelzsicherung 7.5A / Fusible 7.5A</p>	
28	<p>Relay interruttore Relais de coupure Switch Relay Relais-Schalter Realais interruptor</p>	<p>Comando giunto elettromagnetico compressore Commande embrayage électromagnétique du compresseur Compressor electromagnet clutch control Steuerung der elektromagnetischen Kupplung des Kompressors Comando junta electromagnética compresor</p>
29	<p>Fusibile 40A / Fusible 40A / 40A Fuse Schmelzsicherung 40A / Fusible 40A</p>	
30	<p>Relay interruttore Relais de coupure Switch Relay Relais-Schalter Realais interruptor</p>	<p>Comando elettroventola n. 35 Commande électroventilateur n. 35 Controls electric fan no. 35 Steuerung des Elektrolüfter N. 35 Comando electroventilador n. 35</p>
31	<p>Fusibile 50A / Fusible 50A / 50A Fuse Schmelzsicherung 50A / Fusible 50A</p>	
32	<p>Relay interruttore Relais de coupure Switch Relay Relais-Schalter Realais interruptor</p>	<p>Comando elettroventola n. 34 Commande électroventilateur n. 34 Controls electric fan no. 34 Steuerung des Elektrolüfter N. 34 Comando electroventilador n. 34</p>
33	<p>Giunzione RAYCHEM ROSSO Raccord RAYCHEM ROUGE RED RAYCHEM connector RAYCHEM Verbindung ROT Junta RAYCHEM ROJO</p>	



34	Elettroventole Electroventilateur Fan Elektrolüfter Electroventilador	Raffreddamento condensatore Refroidissement condenseur Condenser cooling Kondensatorkühlung Enfriamiento condensador
35	Elettroventole Electroventilateur Fan Elektrolüfter Electroventilador	Raffreddamento condensatore Refroidissement condenseur Condenser cooling Kondensatorkühlung Enfriamiento condensador
36	Giunto elettromagnetico compressore Embrayage électromagnétique du compresseur Compressor electromagnetic clutch Elektromagnetische Kupplung des Kompressors Junta electromagnética del compresor	
37	Pressostato Pressostat Pressure switch Druckwächter Presostato	Protezione impianto A/C Protection équipement A/C A/C system safety device Klimaanlagen-Überlastungsschutz Protección de la instalación A/C
47	Logica funzionamento elettroventola Logique fonctionnement électroventilateur Electric fan logic Betriebslogik der Elektrolüfter Logica funcionamiento electroventilador	

**(I)**

**N.B.:**

Le parti in tratteggio rappresentano componenti dell'impianto elettrico originale.

**(F)**

**N.B.:**

Les parties hachurées représentent des composants du faisceau électrique d'origine.

**(GB)**

**N.B.:**

The dashed parts represent components of the original electric system.

**(D)**

**N.B.:**

Die gestrichelten Teile stellen Bauteile der ursprünglichen Anlage dar.

**(E)**

**N.B.:**

Les partes discontinuas representan componentes de la instalación eléctrica original.

ITALIANO	FRANCAIS	ENGLISH	DEUTSCH	ESPAÑOL
Arancio	Orange	Orange	Orange	Naranjado
Azzurro	D'azur	Light blue	Hellblau	Azul
Bianco	Blanc	White	Weiss	Blanco
Blu	Bleu	Blue	Blau	Turqui
Giallo	Jaune	Yellow	Gelb	Amarillo
Grigio	Gris	Gray	Grau	Gris
Marrone	Marron	Brown	Braun	Marron
Nero	Noir	Black	Schwarz	Negro
Rosa	Rose	Pink	Rosa	Rosa
Rosso	Rouge	Red	Rot	Rojo
Verde	Vert	Green	Grün	Verde
Viola	Violet	Violet	Violett	Violado

**(I)**  
Webasto Diavia mira ad un costante miglioramento dei propri prodotti. La Casa si riserva il diritto di apportare in qualunque momento e senza preavviso modifiche ai modelli e ai componenti descritti in questa pubblicazione per ragioni di natura tecnica o commerciale. Per ulteriori informazioni rivolgersi al servizio assistenza Webasto Diavia.

**(F)**  
Webasto Diavia vise à une amélioration constante des ces produits. La maison se réserve le droit d'apporter, à tout moment et sans préavis, des modifications aux modèles et aux composants décrits dans cette publication pour des raisons d'ordre technique ou commerciale. Pour d'ultérieures informations s'adresser au service d'assistance Webasto Diavia.

**(GB)**  
Webasto Diavia focuses on constant upgrading of its products. The Manufacturer reserves the right to modify the models and components described in the present publication at any time for technical or commercial reasons and without prior notice. For further information, contact Webasto Diavia technical services.

**(D)**  
Webasto Diavia ist stets bestrebt die eigenen Produkte zu verbessern. Die Herstellerfirma behält sich das Recht vor, aus technischen oder Verkaufsgründen, zu jeder Zeit und ohne vorherige Ankündigung, Abänderungen an den Modellen und den in dieser Veröffentlichung beschriebenen Einbauteile vorzunehmen. Für weitere Informationen bitten wir Sie, sich an unseren Webasto Diavia Kundendienst zu wenden.

**(E)**  
Webasto Diavia aspira a un constante mejoramiento de su producción. La Fábrica se reserva el derecho de aportar en cualquier momento y sin preaviso modificaciones a los modelos y los componentes descritos en esta publicación por razones técnicas o comerciales. Para ultiores informaciones dirigirse al servicio asistencia Webasto Diavia.

VENDITA E SERVIZIO  
VENTE ET SERVICE

VERKAUF UND SERVICE  
SALE AND SERVICE

**WEBASTO THERMO & COMFORT ITALY S.r.l.**

Via Nobili, 2 40062 Molinella C.P. 69 (Bologna) - Italy

Telefono (0039) 051.6906316

Fax (0039) 051.6906287

Email: [diavia.service@webasto.com](mailto:diavia.service@webasto.com)



MOD. SCHFI450

V / '13  
(2013)

Questa pubblicazione è stata curata da Webasto Diavia  
Ufficio Documentazione AM - Stabilimento Molinella

This publication has been edited by Webasto Diavia  
AM Documentation Office - Factory Molinella