

TECHNICAL DATA SHEET

ECE602 / ECE604

Unipolar Power Relay

12VDC / 24VDC



GENERAL CHARACTERISTICS

Protection degree: IP65
 Weight: 0.70 Kg approx.
 Contacts: copper coated

FIELDS OF APPLICATION

Markets: industrial vehicles, handling vehicles, pleasure navy, industry...
 Particular applications: starting relay, preheating, motor control, power circuit...

CONTROL CIRCUIT

Connection: M5 terminals
 Tightening torque M5: 3.2 / 3.5 N.m
 Holding power: < 15 W
 Interlocking tension: > 9 VDC (12V) / 16 VDC (24V)
 Disengaging tension: < 7 VDC (12V) / 9 VDC (24V)

POWER CIRCUIT

Connection by M8 terminals
 Tightening torque: 12 / 13 N.m
 Type: normally opened unipolar
 Nominal intensity: 200 A
 Max. capacity: 400 A during 30 seconds

PARTICULAR CHARACTERISTICS:

Temperature range: -40 to +85 degrees C
 Black galvanised finishing.

Size diagrams:

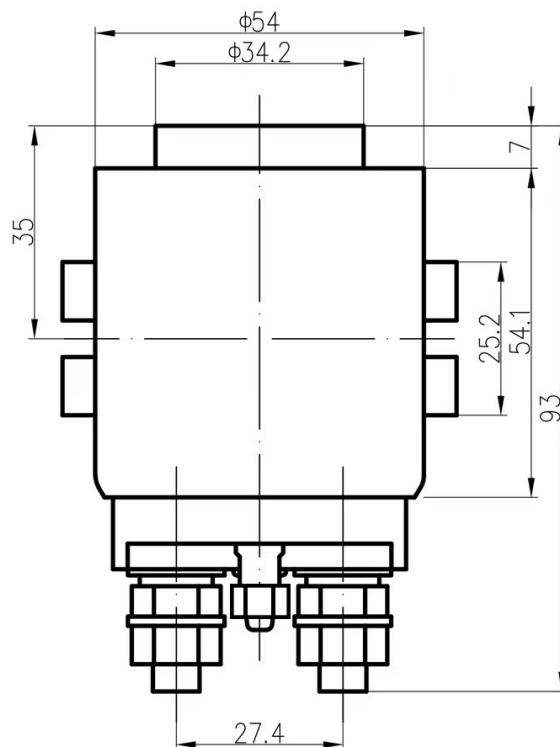
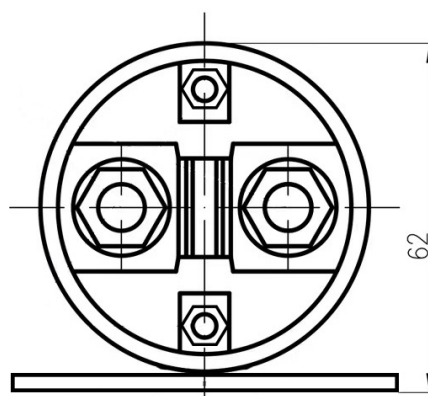

CIRCUIT:

